

Terminals

TS 35	A.2	- A.57
TS 32	B.2	- B.70
TS 35 + TS 32	C.2	- C.5
Modular terminals for high-temperature applications	D.2	- D.3
Nuclear power terminal blocks	D.4	- D.9
TS 15	E.2	- E.15

Multipin terminal strips

F.2 - F.7

Other conductor connectors

G.2 - G.11

Busbar systems

H.2 - H.11

Accessories

I.2 - I.21

Tools

J.2 - J.24

Marking systems

K.2 - K.22

Technical dictionary

W.2 - W.29

Index

Type Index	X.3	- X.11
Order Number Index	X.12	- X.23
The whole world of connection-technology	X.24	- X.25
Addresses abroad	X.26	- X.27

“SAK – A real classic that became synonymous with connection technology”



**Or
“Once upon a time there was a company called Weidmüller that created the best terminals in the world using plastic and metal”.**

Weidmüller has an interesting story to tell about SAK terminals. SAK (German abbreviation for "side-by-side mountable terminals") is the designation for a terminal that has proven itself on the market for more than 55 years. Using the side-by-side mounting principle, electrical terminals made of plastic replaced breakable porcelain constructions in switchgear cabinets. One could as a result say: "SAK was the first family of terminals in the world that helped the electrical industry make a technological breakthrough". Further developments of the terminals and passive connection technology form the Weidmüller group's traditional core business.

SAK wire connections – synonymous with reliable connections and product variety.

This long-term experience in the market enabled many improvements to be made. Nobody can claim that any other terminal on this earth has had as much know-how put into it as the SAK.

A great deal of know-how has been put into the inconspicuous insulating body with "clamping function" for electrical wires. This is because terminals have to withstand all kinds of unfavourable conditions. The connections system is chosen according to the respective application.

When looked at more closely, the demands made of an allegedly trivial component such as a terminal are considerable. Appropriately, the EN 60 947-7-1 defines terminals and cable connectors as equipment for connecting and joining electrical wires. Terminals can be mounted side-by-side or staggered, have two or several, independently functioning connection points, and are insulated both from one another and their mountings. They are mounted, for example, onto mounting rails.

As well as joining the wiring, terminals are also equipped with further functions: when fitted with markers, terminals make it possible to clearly arrange "electrical installations". Moreover, they create a defined connection point that can be extended as required. From this point, the wiring is routed to individual devices in the switchgear cabinet or from the switchgear cabinet to the devices. Terminal blocks increase serviceability, because electrical measurements can be carried out on them, targeted circuits can be opened or protected with appropriate protective elements.

Furthermore, cross-connections can be used to distribute potentials.

A clamping yoke system is used for securing the wiring in SAK terminals (see figure 1). The tension clamp system optimally combines the specific features of steel and copper. This system has proven itself millions of times over in electrical installations: in rough and aggressive industrial atmospheres, in power stations, ships and railway vehicles as well as in building automation.

The clamping yoke and the terminal screw used in Weidmüller's clamping yoke system are made from case-hardened steel. The clamping yoke unit with a high-strength terminal screw produces the required contact force and presses the conductor against the busbar, which is made either of copper or high-quality brass. The latter being tin coated.

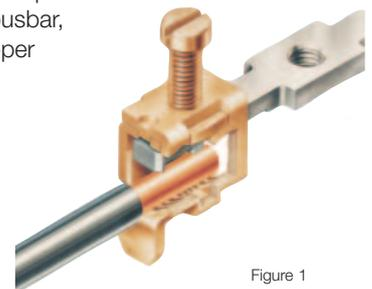

Figure 1

High contact forces with the patented connection system



This ensures a "close fitting" and permanent contact with a low contact resistance. A gas-tight, vibration-resistant connection is created between the conductor and the busbar.

Because even a very good electrically conducting material is only as good as the contact force applied. Weidmüller's patented connection system guarantees high contact forces. This means that it is predestined for use in corrosion-promoting environments; in addition, it is maintenance free. A further aspect is mounting and maintenance on an international scale, made possible by the world-renowned screw connection. One decisive factor for a perfect terminal is the insulating material.

In order to meet the demands placed on terminals, it is necessary to use different insulating materials that are tailor-made for the application – thermoplastic or thermosetting plastic. All insulating materials used by Weidmüller are free from noxious substances and contain no paint pigments based on cadmium. The SAK family especially offers the option of specifically coordinating the terminals with material requirements in mind. In this case, Weidmüller offers the same construction with different insulation materials.

Plastics for terminals – thermoplastics and thermosetting plastics

Thermal plastics are a polyamide (PA), and are one of the most frequently used technical plastics. The advantage of this material is its good electrical and mechanical characteristics, its flexibility and its lack of fracture susceptibility. In addition, this material offers good fire resistance due to its chemical structure without the need for added flameproofing substances. Engineers speak of a so-called "inherent flame protection". The continuous operating temperature of the SAK range is 100 °C, and at the same time offering V2 fire resistance according to UL 94.

Thermosetting plastics possess high dimensional stability, absorb a negligible amount of water, have a very high tracking resistance and excellent fire resistance. The continuous operating temperature is higher in comparison with that of thermoplastics. With increased thermal load, the dimensional stability of thermosetting plastics is better than that of thermoplastics. Their disadvantage: Thermosetting plastics have less flexibility in comparison with thermoplastics.

A further advantage of the SAK family is the large choice of different locking mechanisms. Its mounting rail designs (MR) offer the user the highest possible degree of convenience: TS 35 and TS 32 as well as a combi foot.

Technical background to the screw connection

A spring element forms the basis for Weidmüller's clamping yoke. Turning the terminal screw expands the upper flank of thread slightly, and in so doing locks itself in position. This construction efficiently compensates all expansions in the diameter of the wire (temperature fluctuations).

This has the following advantages:

of course the terminals age when in use; nevertheless, the terminal point does not yield. Consequently, it is not necessary to retighten the terminal screw at a later date nor does the wire become loose: it is resistant to vibration.

The voltage drop remains consistently low.

Weidmüller's technology is completely maintenance free.

Separating the electrical and mechanical functions means that we use steel for a high contact force, and the good electrical conducting properties of copper for a low voltage drop.

SAK – The Classic

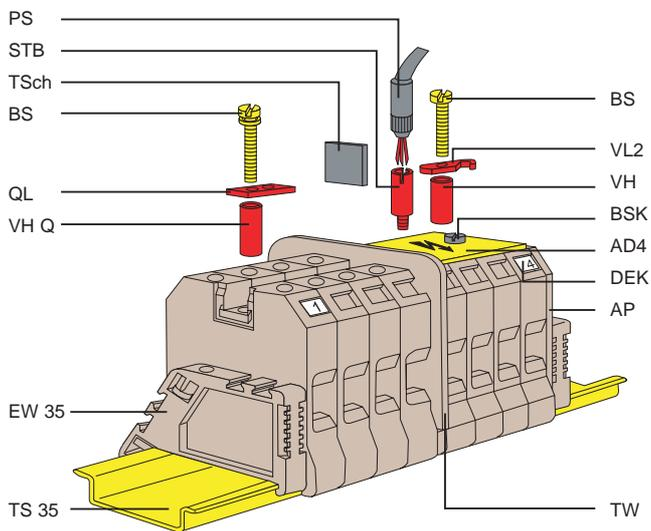

Legend

PS	Test plug
STB	Test socket screw
TSch	Small partition
BS	Fixing screw
QL	Cross-connection link
VH Q	Connection sleeve
EW 35	End brackets
TS 35	Mounting rail
VL	Connection link
BSK	Fixing screw
AD 4	Cover
DEK	Markers
AP	End plate
TW	Partition

The construction of the clamping yoke has been designed in such a manner to ensure that the connection between the wire and the busbar is gas-tight. The surface of the connection must make up at least 75% of the surface as a whole. Electricity is conducted with 100% efficiency at these points, because increased resistances due to soiling of the connection points do not arise. The SAK family is designed for wire cross-sections from 0.08 mm² to 240 mm².

A rundown on the SAK:

- PA 6.6, KrG
Two different materials that can be used, depending on the application, at 100°C or 130°C.
- Three different types of clip-on foot for mounting rail designs 32, 35 or a combination of both.
- Maintenance free and vibration-resistant There is no need to check the terminal point, because the patented clamping yoke construction ensures that the screws remain captive in the terminal.

Separating the tasks completed by the components offers the following advantages:

- Low voltage drop and gas-tight enclosed (electrical components).
Perfect busbars in combination with a special surface treatment in conjunction with a high interference-fit at the terminal point.
- High contact forces, not reliant on the cross-section (mechanical components).
The clamping yoke is made of casehardened steel that, due to its design, can compensate any dimensional instability of the electrical wire.

SAK series

The advantages of all SAK modular terminals:

- Separation of electrical and mechanical functions:
 - steel clamping yoke for the mechanical function
 - copper busbar for the electrical function
- Maintenance-free and vibration-proof screw connection
- Low voltage drop and gas-tight contact point
- High contact forces, not reliant on the cross-section
- Three different clip-on foot designs available
- Various insulation materials
- Large selection of special terminals with diverse connection systems
- Large range of accessories available

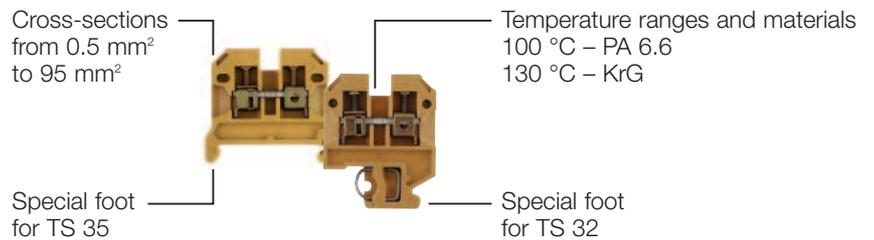
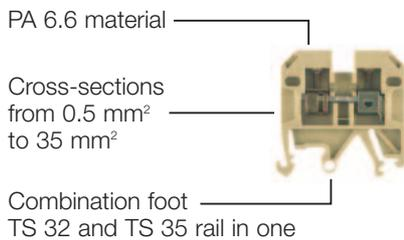
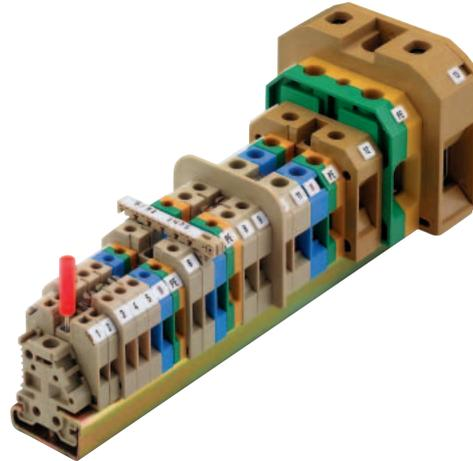

Product range

Clamp type	Rated cross-section						Flat blade connection	Push-on connection	Spring connection	Solder connection
	2.5 mm ²	4 mm ²	6 mm ²	10 mm ²	16 mm ²	35 mm ²				
Modular feed-through terminals										
PA 6.6 / TS 32	•	•	•	•	•	•		•	•	•
KrG / TS 32	•	•	•	•	•	•	•	•	•	•
PA 6.6 / TS 35	•	•	•	•	•	•		•	•	•
KrG / TS 35	•	•	•	•	•	•	•			
PA 6.6 / comb. foot	•	•	•	•	•	•				
PA 6.6 / TS 15	•	•						•		•
Modular 2-tier terminals		•								
Modular PE terminals										
PA 6.6 / TS 32	•	•		•	•	•				
PA 6.6 / TS 35	•	•	•	•	•	•				
PA 6.6 / TS 15	•	•								
Modular fuse terminals										
PA 6.6 / TS 32				•						
PA 6.6 / TS 35				•						
KrG / TS 32				•	•					
KrG / TS 35				•	•					
PA 6.6 / TS 15		•								
PA 6.6 / comb. foot		•								
Modular 2-tier fuse terminals										
PA 6.6 / TS 32		•								
PA 6.6 / TS 35		•								
PA 6.6 / comb. foot		•								
Modular disconnect terminals										
TS 35		•		•						
PA 6.6 / TS 15		•								
Modular 2-tier disconnect terminals		•						•		
Modular ceramic terminals		•		•						

Modular feed-through terminals		
TS 35 / PA	A.2	- A.6
TS 35 / KrG	A.7	- A.10
Spring Loaded Terminal		
TS 35 / PA	A.11	
Double Deck Terminal		
TS 35 / PA	A.12	- A.13
Modular PE terminals		
TS 35 / PA	A.14	- A.17
Disconnect terminals		
TS 35 / PA	A.18	- A.19
TS 35 / KrG	A.20	- A.21
Fuse terminals		
TS 35 / PA	A.22	- A.23
TS 35 / KrG	A.24	- A.27
Fuse inserts and gauge rings for Weidmüller fuse terminals	A.28	- A.29
Installation terminals		
TS 35 / PA	A.30	- A.31
Modular disconnect test terminals		
TS 35 / KrG	A.32	- A.33
Feed-through terminals for thermocouples		
TS 35 / PA	A.34	
Modular terminals with screwless connection		
With tab connection		
TS 35 / PA	A.36	- A.40
With solder connection		
TS 35 / PA	A.41	
Special terminal - SAKG		
TS 35 / KRG	A.42	- A.47
Stud Terminal - KST		
TS 35 / PA	A.48	- A.49
Modular terminals with electronic components		
TS 45 / PA	A.50	- A.57

Modular feed-through terminals

TS 35 / PA

SAKD 2.5/35

2.5 mm²

SAK 2.5

2.5 mm²

TS 35 / PA

A

When using ATEX certified components in hazardous area applications the installation instructions and the rated data for accessories in the technical appendix must be considered.

Width/Length/Height with TS35x7.5	mm
Max. current / max. cond. cross-section	A/mm ²
Max. clamping range	mm ²

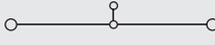
5 x 44 x 38	
24 / 4	
0.08 ... 4	

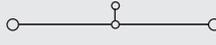
6.1 x 44.1 x 40	
41 / 6	
0.13 ... 6	

Technical data

Rated data	
Rated voltage	V
Rated current	A
Rated cross-section	mm ²
Rated impulse voltage / Pollution severity	kV/-
Plug gauge IEC 60-947-1 / flammability class acc. UL 94	
Approvals	

IEC 60947-7-1

IEC	UL	CSA	EN 50019
500	300	300	
24	20	20	
2.5	AWG 28...12	AWG 22...12	
		6 / 3	
		A2 / V2	

IEC 60947-7-1

IEC	UL	CSA	EN 50019
800	600	600	
24	20	25	
2.5	AWG 22...12	AWG 26...10	
		8 / 3	
		A3 / V2	

Clampable conductors (H05V/H07V)	
Solid / stranded	mm ²
Flexible / flexible w. wire end ferrule	mm ²
Tightening torque range (clamping screw)	Nm
Stripping length / blade size	mm / -



Rated connection	Additional connection
0.5...4 / 0.5...4	
0.5...4 / 0.5...2.5	
0.4...0.6 (M 2.5)	
10 / 3.5 x 0.6	



Rated connection	Additional connection
0.5...6 / 0.5...4	
0.5...4 / 0.5...4	
0.4...0.6 (M 2.5)	
10 / 3.5 x 0.6	

2 clampable conductors of equal cross-section	
Solid / stranded	mm ²
Flexible / flexible w. wire end ferrule	mm ²

0.5...0.75	
0.5...0.75 / 0.5...0.75	

Information
Use of twin wire end ferrules on request

The rated voltage is 630/690 V when using wire end ferrules without end cover or partition plates.
--

Order data

Version	Type	Qty.	Order No.
beige	SAKD 2.5/35	100	0268860000
	SAKD 2.5/35 BL	100	0268880000

Type	Qty.	Order No.
SAK 2.5/35	100	0380460000
SAK 2.5/35 BL	100	0380480000

Information

Information

Accessories

Cross-connection, screwable	
	
	(Q)
2-pole	
3-pole	
4-pole	
10-pole	
Connecting sleeve	
Fixing screw	
Fuse cartridges	

Type	Current [A]	Qty.	Order No.
Q 2 SAKD2.5N	24	50	0367800000
Q 3 SAKD2.5N	24	50	0367900000
Q 4 SAKD2.5N	24	50	0368000000
Q 10 SAKD2.5N	24	20	0368100000

Type	Current [A]	Qty.	Order No.
Q 2 SAK2.5	41	50	0337000000
Q 3 SAK2.5	41	50	0337100000
Q 4 SAK2.5	41	50	0337200000
Q 10 SAK2.5	41	20	0368700000

Cross-connection saddle	
Cross-connection saddle	
Connecting sleeve	
Fixing screw	

Cross-connection saddle	
Cross-connection saddle	
Connecting sleeve	
Fixing screw	

Socket / Test plug	
Socket	
Test plug	

Type	Qty.	Order No.
STB 8.5/D4/2.3/M2.5 AKZ	50	0215700000
PS 2.3 RT	20	0180400000

End plate	
beige	
blue	

Type	Width [mm]	Qty.	Order No.
AP SAKD2.5N	1.5	20	0150960000
AP SAKD2.5N BL	1.5	20	0150980000

Partition / Partition disc	
beige	
blue	
Partition disc	

Type	Width [mm]	Qty.	Order No.
TW SAKD2.5	1.5	20	1918600000
TW SAKD2.5N BL	1.5	20	0191880000
TSCH 3 SAKD2.5 N	5	100	0366860000

Cover / fixing screw (plastic)	
Cover	
Fixing screw (plastic)	

AD 3 SAK2.5	50	0297900000
BFSC M3X22 PA/RT	100	0128900000

Marking systems	
DEK 5	

DEK 6	
-------	--

Detailed information on all versions in chapter accessories.

Modular feed-through terminals

SAK 4

4 mm²

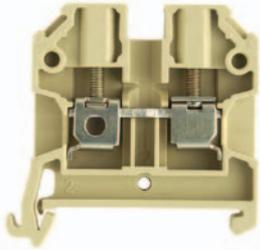

6.5 x 45 x 44
41 / 6
0.13 ... 6

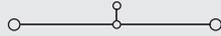

IEC 60947-7-1

IEC	UL	CSA	EN 50019
800	600	600	
32	30	36	
4	AWG 22...12	AWG 26...10	
	8 / 3		
	A4 / V2		



Rated connection	Additional connection
0.5...6 / 0.5...4	
0.5...4 / 0.5...4	
0.5...1.0 (M3)	
12 / 3.5 x 0.6	

1.5...1.5
0.5...1.5

To use twin ferrules is the rated voltage 630/690 V.

SAK 6

6 mm²

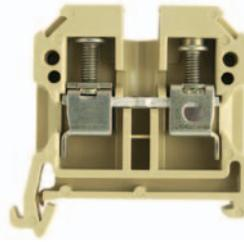

8 x 45 x 44
57 / 10
0.33 ... 10

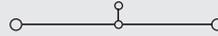

IEC 60947-7-1

IEC	UL	CSA	EN 50019
800	600	600	
41	40	47	
6	AWG 22...8	AWG 20...8	
	8 / 3		
	A5 / V2		



Rated connection	Additional connection
0.5...10 / 0.5...6	
0.5...10 / 0.5...6	
0.8...1.6 (M3.5)	
12 / 4.0 x 0.8	

To use twin ferrules is the rated voltage 630/690 V.

SAK 10

10 mm²



10 x 45 x 51.5
76 / 16
1.5 ... 16

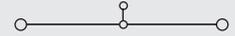

IEC 60947-7-1

IEC	UL	CSA	EN 50019
800	600	600	
57	60	65	
10	AWG 14...6	AWG 14...6	
	8 / 3		
	B6 / V2		



Rated connection	Additional connection
1.5...10 / 1.5...16	
1.5...16 / 1.5...10	
2.0...2.4 (M4)	
12 / 5.5 x 1.0	

Tightening torque 2 Nm for 10 and 16 mm² stranded and AWG 6/7 wire.

Type	Qty.	Order No.
SAK 4/35	100	0443660000
SAK 4/35 BL	100	0443680000

Type	Qty.	Order No.
SAK 6/35	100	0380560000
SAK 6/35 BL	100	0380580000

Type	Qty.	Order No.
SAK 10/35	100	0443760000
SAK 10/35 BL	100	0443780000

Type	Current [A]	Qty.	Order No.
Q 2 SAK4	41	50	0336700000
Q 3 SAK4	41	50	0336800000
Q 4 SAK4	41	50	0336900000
Q 10 SAK4	41	20	0368800000

Type	Current [A]	Qty.	Order No.
Q 2 SAK6N	57	50	0456700000
Q 3 SAK6N	57	50	0456800000
Q 4 SAK6N	57	50	0456900000
Q 10 SAK6N	57	20	0457000000

Type	Current [A]	Qty.	Order No.
Q 2 SAK10	57	50	0457100000
Q 3 SAK10	57	50	0457200000
Q 4 SAK10	57	50	0457300000
Q 10 SAK10	57	20	0457400000

VL 2 SAK4	50	0197000000
VH 19/5/3.5 SAK4-16	50	0285100000
BFSC M3X25	100	0292500000

VL 2 SAK6N/SAKT	50	0194700000
VH 19/5/3.5 SAK4-16	50	0285100000
BFSC M3X25	100	0292500000

VL 2 SAK6/10/SAKB	50	0135900000
VH 19/5/3.5 SAK4-16	50	0285100000
BFSC M3X25	100	0292500000

STB 14/D5/2.3/M3 SAK2.5	50	0168600000
PS 4 F.STB 4	20	0299600000

STB 14/D6/4/M3 SAK10	50	0169900000
PS 4 F.STB 4	20	0299600000

STB 14/D6/4/M3 SAK10	50	0169900000
PS 4 F.STB 4	20	0299600000

Width [mm]			
AP SAK4-10	1.5	20	0117960000
AP SAK4-10 BL	1.5	20	0117980000

Width [mm]			
AP SAK4-10	1.5	20	0117960000
AP SAK4-10 BL	1.5	20	0117980000

Width [mm]			
AP SAK4-10	1.5	20	0117960000
AP SAK4-10 BL	1.5	20	0117980000

Width [mm]			
TW 4 SAK4-10	1.5	20	0130160000
TW 4 SAK4-10 BL	1.5	20	0130180000
TSCH 1	2	100	0319160000

Width [mm]			
TW 4 SAK4-10	1.5	20	0130160000
TW 4 SAK4-10 BL	1.5	20	0130180000
TSCH 1	2	100	0319160000

Width [mm]			
TW 4 SAK4-10	1.5	20	0130160000
TW 4 SAK4-10 BL	1.5	20	0130180000
TSCH 1	2	100	0319160000

AD 4 SAK4	50	0285300000
BFSC M3X22 PA/RT	100	0128900000

AD 4 SAK6N	50	0196600000
BFSC M3X22 PA/RT	100	0128900000

AD 4 SAK10	50	0178600000
BFSC M3X22 PA/RT	100	0128900000

DEK 6,5

DEK 8 / DEK 5

DEK 5

Modular feed-through terminals

TS 35 / PA

SAK 16

SAK 35/35

35 mm²

TS 35 / PA

A

When using ATEX certified components in hazardous area applications the installation instructions and the rated data for accessories in the technical appendix must be considered.

Width/Length/Height with TS35x7.5	mm
Max. current / max. cond. cross-section	A/mm ²
Max. clamping range	mm ²

12 x 50 x 57.5	
76 / 16	
2.5 ... 16	

18 x 58 x 60	
150 / 50	
2.5 ... 50	

Technical data

Rated data	
Rated voltage	V
Rated current	A
Rated cross-section	mm ²
Rated impulse voltage / Pollution severity	kV/-
Plug gauge IEC 60-947-1 / flammability class acc. UL 94 Approvals	

Clampable conductors (H05V/H07V)	
Solid / stranded	mm ²
Flexible / flexible w. wire end ferrule	mm ²
Tightening torque range (clamping screw)	Nm
Stripping length / blade size	mm / -

2 clampable conductors of equal cross-section	
Solid / stranded	mm ²
Flexible / flexible w. wire end ferrule	mm ²

Information

IEC 60947-7-1			
IEC	UL	CSA	EN 50019
1000	600	600	
76	80	87	
	AWG 12...6	AWG 10...6	
	8 / 3		
	B6		

Rated connection		Additional connection	
2.5...16	/	4...16	/
4...16	/	4...16	/
2.0...2.4	(M 4)		
15 / 5.5 x 1.0			

Installation of the QL side by side use a TW/AP.

IEC 60947-7-1			
IEC	UL	CSA	EN 50019
800	600	600	
125	100	145	
35	AWG 12...2	AWG 12...2	
	8 / 3		
	B8 / V2		

Rated connection		Additional connection	
2.5...16	/	4...50	/
2.5...35	/	2.5...35	/
4.0...5.0	(M 6)		
18 / 6.5 x 1.2			

2.5...10	/	10...16	/
2.5...16	/	2.5...16	/

Installation of the QL side by side use a TW/AP.

Order data

Version	
	beige
	blue

Information

Type	Qty.	Order No.
SAK 16/35 PA	50	0380660000
SAK 16/35 BL	50	0380680000

Type	Qty.	Order No.
SAK 35/35	20	0380760000
SAK 35/35 BL	20	0380780000

Accessories

Cross-connection, screwable	
	2-pole
	3-pole
	4-pole
	10-pole
	Connecting sleeve
	Fixing screw
	Fuse cartridges

Cross-connection saddle	
	Cross-connection saddle
	Connecting sleeve
	Fixing screw

Socket / Test plug	
	Socket
	Test plug

End plate	
	beige
	blue

Partition / Partition disc	
	beige
	blue
	Partition disc

Cover / fixing screw (plastic)	
	Cover
	Fixing screw (plastic)

Marking systems

Detailed information on all versions in chapter accessories.

Type	Current [A]	Qty.	Order No.
Q 2 SAK16	76	50	0457500000
Q 3 SAK16	76	50	0457600000
Q 4 SAK16	76	50	0457700000
Q 10 SAK16	76	20	0457800000

Type	Current [A]	Qty.	Order No.
VL 2 SAK16/SAKA		50	0135800000
VH 19/5/3.5 SAK4-16		50	0285100000
BFSC M3X25		100	0292500000

Type	Current [A]	Qty.	Order No.
STB 14/D6/4/M3 SAK10		50	0169900000
PS 4 F.STB 4		20	0299600000

Type	Width [mm]	Qty.	Order No.
AP SAK16	1.5	20	0271160000
AP SAK16 BL	1.5	20	0271180000

Type	Width [mm]	Qty.	Order No.
TSCH 1		2	0319160000

Type	Current [A]	Qty.	Order No.
AD 4 SAK16		50	0518200000
BFSC M3X22 PA/RT		100	0128900000

Type	Current [A]	Qty.	Order No.
DEK 5			

Type	Current [A]	Qty.	Order No.
QL 2 SAK35	99	20	0123600000
QL 3 SAK35	99	20	0123700000
QL 4 SAK35	99	20	0123800000
QL 10 SAK35	99	20	0338600000
VH 17/8/5 SAK35		50	0267000000
BFSC M4X30		50	0267100000
SS M4 D 128-A 4		100	0136400000

Type	Current [A]	Qty.	Order No.
VL 2 SAK35		50	0124000000
VH 24.5/8/5 SAK35		50	0298700000
BFSC M4X35		50	0298900000

Type	Current [A]	Qty.	Order No.
STB 16/D7/4/M4 SAK35		50	0140200000
PS 4 F.STB 4		20	0299600000

Type	Width [mm]	Qty.	Order No.
AP SAK35/TW SAK16	1.5	10	0303660000
AP SAK35/TW SAK16 BL	1.5	10	0303680000

Type	Width [mm]	Qty.	Order No.
TW SAK35	1.5	20	0304360000

Type	Current [A]	Qty.	Order No.
AD 4 SAK35		50	0178700000
BFSC M4X32 PA/RT		100	0129100000

Type	Current [A]	Qty.	Order No.
DEK 5			

Modular feed-through terminals

SAK 35/35/IK

35 mm²

Hexagon socket head screw

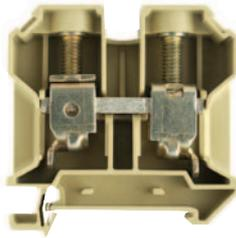

18 x 58 x 60
150 / 50
2.5 ... 50

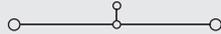

IEC 60947-7-1

IEC	UL	CSA	EN 50019
800	600	600	
125	100	145	
35	AWG 12...2	AWG 12...2	
8 / 3			
B8 / V2			



Rated connection	Additional connection
2.5...16 / 4...50	
2.5...35 / 2.5...35	
4.0...6.0 (M 6)	
18 / S 4 (DIN 6911)	

2.5...10 / 10...16
2.5...16 / 2.5...16

Installation of the QL side by side use a TW/AP.

Type	Qty.	Order No.
SAK 35/35/IK	20	0582460000

SAK 35N/35

35 mm²

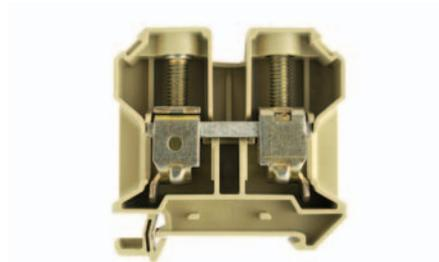

16 x 63 x 60
150 / 50
2.5 ... 50

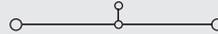

IEC 60947-7-1

IEC	UL	CSA	EN 50019
1000	600	600	
125	105	120	
35	AWG 12...2	AWG 12...2	
8 / 3			
B8 / V2			



Rated connection	Additional connection
2.5...16 / 4...50	
2.5...35 / 1.5...35	
4.0...5.0 (M 6)	
18 / 6,5 x 1,2	

2.5...10 / 10...16
2.5...16 / 2.5...16

Installation of the QL side by side use a TW/AP.

Type	Qty.	Order No.
SAK 35N/35	20	0608260000

SAK 35N/35/IK

35 mm²

Hexagon socket head screw

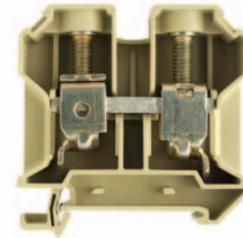

16 x 63 x 60
150 / 50
2.5 ... 50

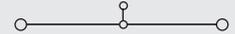

IEC 60947-7-1

IEC	UL	CSA	EN 50019
1000	600	600	
125	105	120	
35	AWG 12...2	AWG 12...2	
8 / 3			
B8 / V2			



Rated connection	Additional connection
2.5...16 / 4...50	
2.5...35 / 1.5...35	
4.0...6.0 (M 6)	
18 / S 4 (DIN 6911)	

2.5...10 / 10...16
2.5...16 / 2.5...16

Installation of the QL side by side use a TW/AP.

Type	Qty.	Order No.
SAK 35N/35/IK	20	0608360000

Type	Current [A]	Qty.	Order No.
QL 2 SAK35	99	20	0123600000
QL 3 SAK35	99	20	0123700000
QL 4 SAK35	99	20	0123800000
QL 10 SAK35	99	20	0338600000
VH 17/8/5 SAK35	50	50	0267000000
BFSC M4X30	50	50	0267100000
SS M4 D 128-A 4	100	100	0136400000
VL 2 SAK35	50	50	0124000000
VH 24.5/8/5 SAK35	50	50	0298700000
BFSC M4X35	50	50	0298900000
STB 16/D7/4/M4 SAK35	50	50	0140200000
PS 4 F.STB 4	20	20	0299600000
Width [mm]			
AP SAK35/TW SAK16	1.5	10	0303660000
AP SAK35/TW SAK16 BL	1.5	10	0303680000
Width [mm]			
TW SAK35	1.5	20	0304360000
AD 4 SAK35	50	50	0178700000
BFSC M4X32 PA/RT	100	100	0129100000
DEK 5			

Type	Current [A]	Qty.	Order No.
QL 2 SAK35N	99	50	0564900000
QL 3 SAK35N	99	50	0565000000
QL 4 SAK35N	99	50	0565100000
QL 10 SAK35N	99	20	0565200000
VH 17/8/5 SAK35	50	50	0267000000
BFSC M4X30	50	50	0267100000
SS M4 D 128-A 4	100	100	0136400000
STB 16/D7/4/M4 SAK35	50	50	0140200000
PS 4 F.STB 4	20	20	0299600000
Width [mm]			
AP SAK35/TW SAK16	1.5	10	0303660000
AP SAK35/TW SAK16 BL	1.5	10	0303680000
Width [mm]			
TW SAK35	1.5	20	0304360000
AD 4 SAK35N	50	50	0576700000
BFSC M4X32 PA/RT	100	100	0129100000
DEK 5			

Type	Current [A]	Qty.	Order No.
QL 2 SAK35N	99	50	0564900000
QL 3 SAK35N	99	50	0565000000
QL 4 SAK35N	99	50	0565100000
QL 10 SAK35N	99	20	0565200000
VH 17/8/5 SAK35	50	50	0267000000
BFSC M4X30	50	50	0267100000
SS M4 D 128-A 4	100	100	0136400000
STB 16/D7/4/M4 SAK35	50	50	0140200000
PS 4 F.STB 4	20	20	0299600000
Width [mm]			
AP SAK35/TW SAK16	1.5	10	0303660000
AP SAK35/TW SAK16 BL	1.5	10	0303680000
Width [mm]			
TW SAK35	1.5	20	0304360000
AD 4 SAK35N	50	50	0576700000
BFSC M4X32 PA/RT	100	100	0129100000
DEK 5			

Modular feed-through terminals

TS 35 / PA

SAK 70/35

70 mm²

TS 35 / PA

A

When using ATEX certified components in hazardous area applications the installation instructions and the rated data for accessories in the technical appendix must be considered.

Width/Length/Height with TS35x7.5	mm
Max. current / max. cond. cross-section	A/mm ²
Max. clamping range	mm ²

22 x 75 x 87
192 / 70
16 ... 70

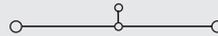

Technical data

Rated data	
Rated voltage	V
Rated current	A
Rated cross-section	mm ²
Rated impulse voltage / Pollution severity	kV/-
Plug gauge IEC 60-947-1 / flammability class acc. UL 94	
Approvals	

IEC 60947-7-1

IEC	UL	CSA	EN 50019
1000	600	600	
192	145	150	
70	AWG 4...2/0	AWG 4...2/0	
			8 / 3
B11 / V2			



Clampable conductors (H05V/H07V)	
Solid / stranded	mm ²
Flexible / flexible w. wire end ferrule	mm ²
Tightening torque range (clamping screw)	Nm
Stripping length / blade size	mm / -

Rated connection	Additional connection
16...16 / 16...70	
16...70 / 16...35	
6.0...12 (M 8)	
24 / S6 (DIN 6911)	

2 clampable conductors of equal cross-section	
Solid / stranded	mm ²
Flexible / flexible w. wire end ferrule	mm ²

Information
Tightening torque 12 Nm for 70 mm ² stranded wire.

Order data

Version
beige
blue

Type	Qty.	Order No.
SAK 70/35	10	0139160000

Information

Accessories

Cross-connection, screwable	
	
2-pole	
3-pole	
4-pole	
10-pole	
Connecting sleeve	
Fixing screw	
Fuse cartridges	

Type	Current [A]	Qty.	Order No.
QL 2 SAK70	192	20	0345300000
QL 3 SAK70	192	5	0167000000
<hr/>			
VH 30.5/11/5.5 SAK70		20	0345500000
BFSC M5X45		20	0345600000
SS M5 D 128-A 5		50	0346100000

Cross-connection saddle	
Cross-connection saddle	
Connecting sleeve	
Fixing screw	

Socket / Test plug	
Socket	
Test plug	

Type	Qty.	Order No.
STB 16/D7/4/M5 SAK70	50	0385400000
PS 4 F.STB 4	20	0299600000

End plate	
beige	
blue	

Type	Width [mm]	Qty.	Order No.
AP SAK70/35	2	10	0340960000

Partition / Partition disc	
beige	
blue	
Partition disc	

Type	Width [mm]	Qty.	Order No.

Cover / fixing screw (plastic)	
Cover	
Fixing screw (plastic)	

Type	Qty.	Order No.
AD 3 SAK70	10	0344300000
BFSC M5X45 PA/NA	50	0344400000

Marking systems

DEK 5

Detailed information on all versions in chapter accessories.

Modular feed-through terminals

TS 35 / KrG

SAK 2.5

2.5 mm²

SAK 4

4 mm²

When using ATEX certified components in hazardous area applications the installation instructions and the rated data for accessories in the technical appendix must be considered.

Width/Length/Height with TS35x7.5	mm
Max. current / max. cond. cross-section	A/mm ²
Max. clamping range	mm ²

Technical data

Rated data	
Rated voltage	V
Rated current	A
Rated cross-section	mm ²
Rated impulse voltage / Pollution severity	kV/-
Plug gauge IEC 60-947-1 / flammability class acc. UL 94 Approvals	

Clampable conductors (H05V/H07V)	
Solid / stranded	mm ²
Flexible / flexible w. wire end ferrule	mm ²
Tightening torque range (clamping screw)	Nm
Stripping length / blade size	mm / -

2 clampable conductors of equal cross-section	
Solid / stranded	mm ²
Flexible / flexible w. wire end ferrule	mm ²

Information

Order data

Version	
yellow	
blue	

Information

Accessories

Cross-connection, screwable	
	
	(Q)
2-pole	
3-pole	
4-pole	
10-pole	
Connecting sleeve	
Fixing screw	
Fuse cartridges	

Cross-connection saddle	
Cross-connection saddle	
Connecting sleeve	
Fixing screw	

Socket / Test plug	
Socket	
Test plug	

End plate	
yellow	
blue	

Partition / Partition disc	
yellow	
blue	
Partition disc	

Cover / fixing screw (plastic)	
Cover	
Fixing screw (plastic)	

Marking systems	

Detailed information on all versions in chapter accessories.

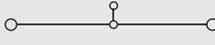

6.1 x 49.5 x 40	
32 / 6	
0.13 ... 6	

IEC 60947-7-1			
IEC	UL	CSA	EN 50019
800	600	600	
24	20	25	
2.5	AWG 22...12	AWG 26...10	
		8 / 3	
		A3 / 5VA	

Rated connection		Additional connection	
0.5...6	/ 0.5...4		
0.5...4	/ 0.5...2.5		
0.4...0.6	(M 2.5)		
10 / 3.5 x 0.6			

The rated voltage is 630/690 V when using wire end ferrules without end cover or partition plates.

Type	Qty.	Order No.
SAK 2.5/35 KRG	100	0380420000
SAK 2.5/35 KRG/BL	100	0380470000

Information

Type	Current [A]	Qty.	Order No.
Q 2 SAK2.5	41	50	0337000000
Q 3 SAK2.5	41	50	0337100000
Q 4 SAK2.5	41	50	0337200000
Q 10 SAK2.5	41	20	0368700000

Width [mm]	
AP SAK2.5 KRG	1.5 20 0279520000
AP SAK2.5 KRG/BL	1.5 20 0279570000

Width [mm]	
TW SAK2.5 KRG	2.5 20 0302820000
TW SAK2.5 KRG/BL	2.5 20 0302870000
TSCH 1	2 100 0319160000

Width [mm]	
AD 4 AKZ4	50 0303400000
BFSC M3X22 PA/RT	100 0128900000

Width [mm]	
DEK 6	

Width [mm]	
TW SAK4-10 KRG	2.5 20 0130120000
TW SAK4-10 KRG/BL	2.5 20 0130170000
TSCH 1	2 100 0319160000

Width [mm]	
AD 4 SAK4	50 0285300000
BFSC M3X22 PA/RT	100 0128900000

Width [mm]	
DEK 6,5	

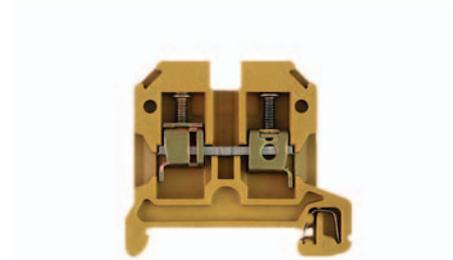

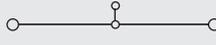
6.5 x 45 x 44	
41 / 6	
0.13 ... 6	

IEC 60947-7-1			
IEC	UL	CSA	EN 50019
800	600	600	
32	30	36	
4	AWG 22...12	AWG 26...10	
		8 / 3	
		A4 / 5VA	

Rated connection		Additional connection	
0.5...6	/ 0.5...4		
0.5...4	/ 0.5...4		
0.5...1.0	(M 3)		
12 / 3.5 x 0.6			

To use twin ferrules is the rated voltage 630/690 V.

Type	Qty.	Order No.
SAK 4/35 KRG	100	0443620000
SAK 4/35 KRG/BL	100	0443670000

Information

Type	Current [A]	Qty.	Order No.
Q 2 SAK4	41	50	0336700000
Q 3 SAK4	41	50	0336800000
Q 4 SAK4	41	50	0336900000
Q 10 SAK4	41	20	0368800000

Width [mm]	
VL 2 SAK4	50 0197000000
VH 19/5/3.5 SAK4-16	50 0285100000
BFSC M3X25	100 0292500000

Width [mm]	
STB 14/D5/2.3/M3 SAK2.5	50 0168600000
PS 2.3 RT	20 0180400000

Width [mm]	
AP SAK4-10 KRG	1.5 20 0117920000
AP SAK4-10 KRG/BL	1.5 20 0117970000

Width [mm]	
TW SAK4-10 KRG	2.5 20 0130120000
TW SAK4-10 KRG/BL	2.5 20 0130170000
TSCH 1	2 100 0319160000

Width [mm]	
AD 4 SAK4	50 0285300000
BFSC M3X22 PA/RT	100 0128900000

Width [mm]	
DEK 6,5	

Modular feed-through terminals

TS 35 / KrG

SAK 6

6 mm²

SAK 10

10 mm²

TS 35 / KrG

A

When using ATEX certified components in hazardous area applications the installation instructions and the rated data for accessories in the technical appendix must be considered.

Width/Length/Height with TS35x7.5	mm
Max. current / max. cond. cross-section	A/mm ²
Max. clamping range	mm ²

8 x 45 x 44
57 / 10
0.33 ... 10

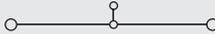

10 x 45 x 51.5
76 / 16
1.5 ... 16

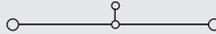

Technical data

Rated data	
Rated voltage	V
Rated current	A
Rated cross-section	mm ²
Rated impulse voltage / Pollution severity	kV/-
Plug gauge IEC 60-947-1 / flammability class acc. UL 94 Approvals	

IEC 60947-7-1

IEC	UL	CSA	EN 50019
800	600	600	
41	40	47	
6	AWG 22...8	AWG 20...8	
8 / 3			
A5 / 5VA			

IEC 60947-7-1

IEC	UL	CSA	EN 50019
800	600	600	
57	60	65	
10	AWG 14...6	AWG 14...6	
8 / 3			
B6 / 5VA			

Clampable conductors (H05V/H07V)	
Solid / stranded	mm ²
Flexible / flexible w. wire end ferrule	mm ²
Tightening torque range (clamping screw)	Nm
Stripping length / blade size	mm / -

Rated connection	Additional connection
0.5...10 / 0.5...6	
0.5...10 / 0.5...6	
0.8...1.6 (M 3.5)	
12 / 4.0 x 0.8	

Rated connection	Additional connection
1.5...10 / 1.5...16	
1.5...16 / 1.5...10	
2.0...2.4 (M 4)	
12 / 5.5 x 1.0	

2 clampable conductors of equal cross-section	
Solid / stranded	mm ²
Flexible / flexible w. wire end ferrule	mm ²

To use twin ferrules is the rated voltage 630/690 V.

Tightening torque 2 Nm for 10 and 16 mm² stranded and AWG 6/7 wire.

Information

Order data

Version	
yellow	
blue	

Type	Qty.	Order No.
SAK 6/35 KRG	100	0380520000
SAK 6/35 KRG/BL	100	0380570000

Type	Qty.	Order No.
SAK 10/35 KRG	100	0443720000
SAK 10/35 KRG/BL	100	0443770000

Information

Accessories

Cross-connection, screwable	
	2-pole
	3-pole
	4-pole
	10-pole
	Connecting sleeve
	Fixing screw
	Fuse cartridges

Type	Current [A]	Qty.	Order No.
Q 2 SAK6N	57	50	0456700000
Q 3 SAK6N	57	50	0456800000
Q 4 SAK6N	57	50	0456900000
Q 10 SAK6N	57	20	0457000000

Type	Current [A]	Qty.	Order No.
Q 2 SAK10	57	50	0457100000
Q 3 SAK10	57	50	0457200000
Q 4 SAK10	57	50	0457300000
Q 10 SAK10	57	20	0457400000

Cross-connection saddle	
Cross-connection saddle	
Connecting sleeve	
Fixing screw	

Type	Current [A]	Qty.	Order No.
VL 2 SAK6N/SAKT	50	50	0194700000
VH 19/5/3.5 SAK4-16	50	50	0285100000
BFSC M3X25	100	100	0292500000

Type	Current [A]	Qty.	Order No.
VL 2 SAK6/10/SAKB	50	50	0135900000
VH 19/5/3.5 SAK4-16	50	50	0285100000
BFSC M3X25	100	100	0292500000

Socket / Test plug	
Socket	
Test plug	

Type	Current [A]	Qty.	Order No.
STB 14/D6/4/M3 SAK10	50	50	0169900000
PS 4 F.STB 4	20	20	0299600000

Type	Current [A]	Qty.	Order No.
STB 14/D6/4/M3 SAK10	50	50	0169900000
PS 4 F.STB 4	20	20	0299600000

End plate	
yellow	
blue	

Type	Width [mm]	Current [A]	Qty.	Order No.
AP SAK4-10 KRG	1.5	20	20	0117920000
AP SAK4-10 KRG/BL	1.5	20	20	0117970000

Type	Width [mm]	Current [A]	Qty.	Order No.
AP SAK4-10 KRG	1.5	20	20	0117920000
AP SAK4-10 KRG/BL	1.5	20	20	0117970000

Partition / Partition disc	
yellow	
blue	
Partition disc	

Type	Width [mm]	Current [A]	Qty.	Order No.
TW SAK4-10 KRG	2.5	20	20	0130120000
TW SAK4-10 KRG/BL	2.5	20	20	0130170000
TSCH 1	2	100	100	0319160000

Type	Width [mm]	Current [A]	Qty.	Order No.
TW SAK4-10 KRG	2.5	20	20	0130120000
TW SAK4-10 KRG/BL	2.5	20	20	0130170000
TSCH 1	2	100	100	0319160000

Cover / fixing screw (plastic)	
Cover	
Fixing screw (plastic)	

Type	Current [A]	Qty.	Order No.
AD 4 SAK6N	50	50	0196600000
BFSC M3X22 PA/RT	100	100	0128900000

Type	Current [A]	Qty.	Order No.
AD 4 SAK10	50	50	0178600000
BFSC M3X22 PA/RT	100	100	0128900000

Marking systems

DEK 8

DEK 5

Detailed information on all versions in chapter accessories.

Modular feed-through terminals

SAK 16

16 mm²

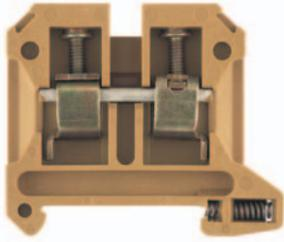

12 x 50 x 57.5
76 / 16
2.5 ... 16

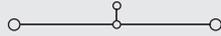

IEC 60947-7-1

IEC	UL	CSA	EN 50019
1000	600	600	
76	80	87	
16	AWG 12...6	AWG 10...6	
	8 / 3		
	B6 / 5VA		



Rated connection	Additional connection
2.5...16 / 4...16	
4...16 / 4...16	
2.0...2.4 (M 4)	
15 / 5.5 x 1.0	

Installation of the QL side by side use a TW/AP.

SAK 35N/35

35 mm²

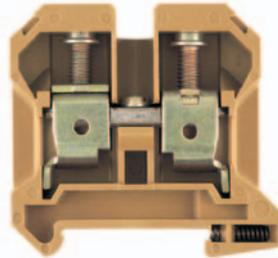

16 x 63 x 60
125 / 50
2.5 ... 50

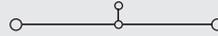

IEC 60947-7-1

IEC	UL	CSA	EN 50019
1000	600	600	
125	105	120	
35	AWG 12...2	AWG 12...2	
	8 / 3		
	B8 / 5VA		



Rated connection	Additional connection
2.5...16 / 4...50	
2.5...35 / 1.5...35	
4.0...5.0 (M 6)	
18 / 6.5 x 1.2	

Installation of the QL side by side use a TW/AP.

SAK 35N/35/IK

35 mm²

Hexagon socket head screw

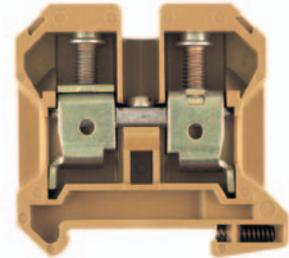

16 x 63 x 60
125 / 50
2.5 ... 50

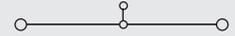

IEC 60947-7-1

IEC	UL	CSA	EN 50019
1000	600	600	
125	105	120	
35	AWG 12...2	AWG 12...2	
	8 / 3		
	B8 / 5VA		



Rated connection	Additional connection
2.5...16 / 4...50	
2.5...35 / 1.5...35	
4.0...6.0 (M 6)	
18 / S 4 (DIN 6911)	

Installation of the QL side by side use a TW/AP.

Type	Qty.	Order No.
SAK 16/35 KRG	50	0380620000

Type	Qty.	Order No.
SAK 35N/35 KRG	20	0608220000

Type	Qty.	Order No.
SAK 35N/35/IK KRG	20	0608320000
SAK 35N/35/IK KRG/BL	20	0608370000

Type	Current [A]	Qty.	Order No.
Q 2 SAK16	76	50	0457500000
Q 3 SAK16	76	50	0457600000
Q 4 SAK16	76	50	0457700000
Q 10 SAK16	76	20	0457800000

Type	Current [A]	Qty.	Order No.
QL 2 SAK35N	99	50	0564900000
QL 3 SAK35N	99	50	0565000000
QL 4 SAK35N	99	50	0565100000
QL 10 SAK35N	99	20	0565200000
VH 17/8/5 SAK35	50	50	0267000000
BFSC M4X30	50	50	0267100000
SS M4 D 128-A 4	100	100	0136400000

Type	Current [A]	Qty.	Order No.
QL 2 SAK35N	99	50	0564900000
QL 3 SAK35N	99	50	0565000000
QL 4 SAK35N	99	50	0565100000
QL 10 SAK35N	99	20	0565200000
VH 17/8/5 SAK35	50	50	0267000000
BFSC M4X30	50	50	0267100000
SS M4 D 128-A 4	100	100	0136400000

VL 2 SAK16/SAKA	50	0135800000
VH 19/5/3.5 SAK4-16	50	0285100000
BFSC M3X25	100	0292500000

STB 16/D7/4/M4 SAK35	50	0140200000
PS 4 F.STB 4	20	0299600000

STB 16/D7/4/M4 SAK35	50	0140200000
PS 4 F.STB 4	20	0299600000

Width [mm]			
AP SAK16 KRG	3	20	0271120000

Width [mm]			
AP SAK35 KRG	3	10	0303620000
AP SAK35 KRG/BL	3	10	0303670000

Width [mm]			
AP SAK35 KRG	3	10	0303620000
AP SAK35 KRG/BL	3	10	0303670000

Width [mm]			
TW SAK16 KRG	3	20	0281120000

Width [mm]			
TW SAK35 KRG	3	20	0304320000

Width [mm]			
TW SAK35 KRG	3	20	0304320000

TSCH 1	2	100	0319160000
--------	---	-----	------------

AD 4 SAK35	50	0178700000
BFSC M3X22 PA/RT	100	0128900000

AD 4 SAK35N	50	0576700000
BFSC M4X32 PA/RT	100	0129100000

AD 4 SAK16	50	0518200000
BFSC M3X22 PA/RT	100	0128900000

AD 4 SAK35	50	0178700000
BFSC M3X22 PA/RT	100	0128900000

AD 4 SAK35N	50	0576700000
BFSC M4X32 PA/RT	100	0129100000

DEK 5			
-------	--	--	--

DEK 5			
-------	--	--	--

DEK 5			
-------	--	--	--

Modular feed-through terminals

TS 35 / KrG

SAK 95/35

95 mm²

TS 35 / KrG

A

When using ATEX certified components in hazardous area applications the installation instructions and the rated data for accessories in the technical appendix must be considered.

Width/Length/Height with TS35x7.5	mm
Max. current / max. cond. cross-section	A/mm ²
Max. clamping range	mm ²

28 x 83.5 x 96.5

269 / 120

16 ... 120

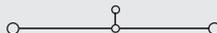

Technical data

Rated data

Rated voltage	V
Rated current	A
Rated cross-section	mm ²
Rated impulse voltage / Pollution severity	kV/-
Plug gauge IEC 60-947-1 / flammability class acc. UL 94	
Approvals	

IEC 60947-7-1

IEC	UL	CSA	EN 50019
1000	600	600	
232	190	210	
95	AWG 6...3/0	AWG 6...3/0	
			8 / 3
B12 / 5VA			



Clampable conductors (H05V/H07V)

Solid / stranded	mm ²
Flexible / flexible w. wire end ferrule	mm ²
Tightening torque range (clamping screw)	Nm
Stripping length / blade size	mm / -

Rated connection

16...16 / 10...120
16...95 / 10...35
16...20 (M 10)
30 / S8 (DIN 6911)

Additional connection

2 clampable conductors of equal cross-section

Solid / stranded	mm ²
Flexible / flexible w. wire end ferrule	mm ²

Information

Order data

Version

yellow
blue

Information

Type

SAK 95/35 KRG

Qty.

10

Order No.

0662220000

Accessories

Cross-connection, screwable



(Q)

2-pole
3-pole
4-pole
10-pole
Connecting sleeve
Fixing screw
Fuse cartridges

Type

QL 2 SAKG28
QL 3 SAKG28
QL 4 SAKG28

Current [A]

Qty.

10
5
5

Order No.

0551200000
0407600000
0407700000

Cross-connection saddle

Cross-connection saddle
Connecting sleeve
Fixing screw

Socket / Test plug

Socket
Test plug

STB 16/D7/4/M5 SAK70
PS 4 F.STB 4

50
20

0385400000
0299600000

End plate

yellow
blue

AP SAK95 KRG
AP SAK95 KRG/BL

3
3

10
10

0550920000
0550970000

Partition / Partition disc

yellow
blue
Partition disc

Cover / fixing screw (plastic)

Cover
Fixing screw (plastic)

ADP 3/HP3 1M
BFSC M5X45 PA/NA

1
50

0485400000
0344400000

Marking systems

DEK 5

Detailed information on all versions in chapter accessories.

Holder HP 3 0485760000 for the ADP 3-Profil.

Spring Loaded Terminal

TS 35 / PA

RSF 3/35

4 mm²

When using ATEX certified components in hazardous area applications the installation instructions and the rated data for accessories in the technical appendix must be considered.

Width/Length/Height with TS35x7.5	mm
Max. current / max. cond. cross-section	A/mm ²
Max. clamping range	mm ²

8 x 50 x 60
32 / 4
0.5 ... 4

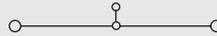

Technical data

Rated data	
Rated voltage	V
Rated current	A
Rated cross-section	mm ²
Rated impulse voltage / Pollution severity	kV/-
Plug gauge IEC 60-947-1 / flammability class acc. UL 94	
Approvals	

IEC 60947-7-1

IEC	UL	CSA	EN 50019
630	600	600	
32	20	25	
4	AWG 22...12	AWG 22...12	
		6 / 3	
		/ V2	



Clampable conductors (H05V/H07V)	
Solid / stranded	mm ²
Flexible / flexible w. wire end ferrule	mm ²
Tightening torque range (clamping screw)	Nm
Stripping length / blade size	mm / -

Rated connection	Additional connection
0.5...4 / 0.5...4	
0.5...4 / 0.5...4	
0.5...1.0 (M3)	
12 / 3.5 x 0.6	

2 clampable conductors of equal cross-section	
Solid / stranded	mm ²
Flexible / flexible w. wire end ferrule	mm ²

Information

Order data

Version	
	beige
	blue

Type	Qty.	Order No.
RSF 3/35	50	9501160000

Information

Accessories

Cross-connection, screwable	
	2-pole
	3-pole
	4-pole
	10-pole
	Connecting sleeve
	Fixing screw
	Fuse cartridges

Type	Current [A]	Qty.	Order No.
QL 2 SAK6N	57	50	0194300000
QL 3 SAK6N	57	50	0194400000
QL 4 SAK6N	57	50	0194500000
QL 10 SAK6N	57	20	0338300000
VH 13.5/4.9/3.3 SAK4		100	0248500000
KISC M3X20.5/10 EK4		100	0303000000
SS M3 D 128-A 3		50	0164400000

Cross-connection saddle	
	Cross-connection saddle
	Connecting sleeve
	Fixing screw

VL 2 SAK6N/SAKT	50	0194700000
VH 21/5/3.5 SAK16-35	50	0309600000
BFSC M3X30	50	0296200000

Socket / Test plug	
	Socket
	Test plug

STB 14/D5/2.3/M3 SAK2.5	50	0168600000
PS 2.3 RT	20	0180400000

End plate	
	beige
	blue

Width [mm]			
AP RSF3	3	10	0270460000

Partition / Partition disc	
	beige
	blue
	Partition disc

Width [mm]			
TW AST1/PA HP/DBR/0.5	0.5	20	0474700000
TSCH 1	2	100	0319160000

Cover / fixing screw (plastic)	
	Cover
	Fixing screw (plastic)

ADP 2/HP2 1M	36	0485300000
--------------	----	------------

Marking systems

DEK 5

Detailed information on all versions in chapter accessories.

Double Deck Terminal

TS 35 / PA

DK 4/35

4 mm²

DK 4 Q/35

4 mm²

TS 35 / PA

A

When using ATEX certified components in hazardous area applications the installation instructions and the rated data for accessories in the technical appendix must be considered.

Width/Length/Height with TS35x7.5	mm
Max. current / max. cond. cross-section	A/mm ²
Max. clamping range	mm ²

6 x 54 x 60.5	
41 / 6	
0.13 ... 6	

6 x 54 x 60.5	
41 / 6	
0.13 ... 6	

Technical data

Rated data	
Rated voltage	V
Rated current	A
Rated cross-section	mm ²
Rated impulse voltage / Pollution severity	kV/-
Plug gauge IEC 60-947-1 / flammability class acc. UL 94	
Approvals	

IEC 60947-7-1

IEC	UL	CSA	EN 50019
500	300	300	
32	27	10	
4	AWG 22...12	AWG 26...12	
		6 / 3	
		A3 / V2	

IEC 60947-7-1

IEC	UL	CSA	EN 50019
500	300	300	
32	27	10	
4	AWG 22...12	AWG 26...12	
		6 / 3	
		A3 / V2	

Clampable conductors (H05V/H07V)	
Solid / stranded	mm ²
Flexible / flexible w. wire end ferrule	mm ²
Tightening torque range (clamping screw)	Nm
Stripping length / blade size	mm / -



Rated connection	Additional connection
0.5...6 / 0.5...4	
0.5...4 / 0.5...2.5	
0.6...0.8 (M3)	
8 / 3.5 x 0.6	



Rated connection	Additional connection
0.5...6 / 0.5...4	
0.5...4 / 0.5...2.5	
0.6...0.8 (M3)	
8 / 3.5 x 0.6	

2 clampable conductors of equal cross-section	
Solid / stranded	mm ²
Flexible / flexible w. wire end ferrule	mm ²

0.5...1.5	
0.5...1.5 / 0.5...1.5	

0.5...1.5	
0.5...1.5 / 0.5...1.5	

Information

Information

Order data

Version	Type	Qty.	Order No.
beige	DK 4/35	100	0527660000
blue	DK 4/35 BL	100	0527680000

Type	Qty.	Order No.
DK 4/35	100	0527660000
DK 4/35 BL	100	0527680000

Type	Qty.	Order No.
DK 4Q/35	100	0590160000
DK 4Q/35 BL	100	0590180000

Information

Information

Accessories

Cross-connection, screwable	
	2-pole
	3-pole
	4-pole
	10-pole
	Connecting sleeve
	Fixing screw
	Fuse cartridges

Type	Current [A]	Qty.	Order No.
Q 2 AKZ4	32	50	0336400000
Q 3 AKZ4	32	50	0336500000
Q 4 AKZ4	32	50	0336600000
Q 10 AKZ4	32	20	0368600000

Type	Current [A]	Qty.	Order No.
Q 2 AKZ4	32	50	0336400000
Q 3 AKZ4	32	50	0336500000
Q 4 AKZ4	32	50	0336600000
Q 10 AKZ4	32	20	0368600000

Cross-connection saddle	
	Cross-connection saddle
	Connecting sleeve
	Fixing screw

Cross-connection saddle	
	Cross-connection saddle
	Connecting sleeve
	Fixing screw

Socket / Test plug	
	Socket
	Test plug

Type	Qty.	Order No.
STB 8.5/D4/2.3/M2.5 AKZ	50	0215700000
PS 2.3 RT	20	0180400000

Type	Qty.	Order No.
STB 8.5/D4/2.3/M2.5 AKZ	50	0215700000
PS 2.3 RT	20	0180400000

End plate	
	beige
	blue

Type	Width [mm]	Qty.	Order No.
AP DK4	1.5	20	0359260000
AP DK4 BL	1.5	20	0359280000

Type	Width [mm]	Qty.	Order No.
AP DK4Q	1.5	20	1397160000
AP DK4Q BL	1.5	20	1397180000

Partition / Partition disc	
	beige
	blue
	Partition disc

Type	Width [mm]	Qty.	Order No.
WTW EN	3	20	1058800000
TSCH 6 DK1 S4	5	100	0190260000

Type	Width [mm]	Qty.	Order No.
WTW EN	3	20	1058800000
TSCH 6 DK1 S4	5	100	0190260000

Cover / fixing screw (plastic)	
	Cover
	Fixing screw (plastic)

AD 3 SAK2.5	50	0297900000
BFSC M2.5X18 PA/RT	100	0303300000

AD 3 SAK2.5	50	0297900000
BFSC M2.5X18 PA/RT	100	0303300000

Marking systems	
	DEK 6

DEK 6	
-------	--

DEK 6	
-------	--

Detailed information on all versions in chapter accessories.

Detailed information on all versions in chapter accessories.

Double Deck Terminal

DK 4 QV/35

4 mm²

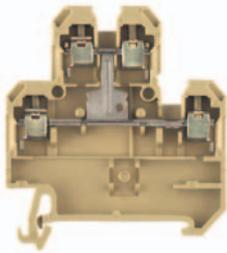

6 x 54 x 40.5

41 / 6

0.13 ... 6

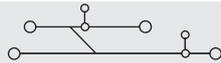

IEC 60947-7-1

IEC	UL	CSA	EN 50019
500	300	300	
32	27	10	
4	AWG 22...12	AWG 26...12	
	6 / 3		
	A3 / V2		



Rated connection	Additional connection
0.5...6 / 0.5...4	
0.5...4 / 0.5...2.5	
0.6...0.8 (M 3)	
8 / 3.5 x 0.6	

0.5...1.5

0.5...1.5 / 0.5...1.5

Type	Qty.	Order No.
DK 4QV/35	100	0363660000
DK 4QV/35 BL	100	0363680000

Type	Current [A]	Qty.	Order No.
Q 2 AKZ4	32	50	0336400000
Q 3 AKZ4	32	50	0336500000
Q 4 AKZ4	32	50	0336600000
Q 10 AKZ4	32	20	0368600000

STB 8.5/D4/2.3/M2.5 AKZ	50	0215700000
PS 2.3 RT	20	0180400000

Width [mm]

AP DK4Q	1.5	20	1397160000
AP DK4Q BL	1.5	20	1397180000

Width [mm]

WTW EN	3	20	1058800000
--------	---	----	------------

TSCH 6 DKI S4	5	100	0190260000
---------------	---	-----	------------

AD 4 AKZ4	50	0303400000
-----------	----	------------

BFSC M2.5X18 PA/RT	100	0303300000
--------------------	-----	------------

DEK 6

Modular PE terminals

TS 35 / PA

EK 2.5/35

2.5 mm²

EK 4/35

4 mm²

TS 35 / PA

A

When using ATEX certified components in hazardous area applications the installation instructions and the rated data for accessories in the technical appendix must be considered.

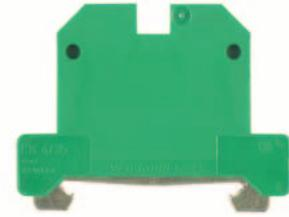

Width/Length/Height with TS35x7.5 mm
 Max. current / max. cond. cross-section A/mm²
 Max. clamping range mm²

6 x 56.6 x 40
/ 6
0.33 ... 6

6.5 x 56.5 x 44
/ 6
0.33 ... 6

Technical data

Rated data	
Rated cross-section	mm ²
Rated voltage for adjacent terminal	V
Rated impulse voltage / Pollution severity	kV
Short-duration withstand current	A
Pollution severity	
Plug gauge IEC 60-947-1 / flammability class acc. UL 94 Approvals	

IEC 60947-7-2

IEC	UL	CSA	EN 50019
2.5	AWG 22... 12	AWG 26... 10	
800			
8			
	480 A (4 mm ²)		
	3		
	A3 / V2		

IEC 60947-7-2

IEC	UL	CSA	EN 50019
4	AWG 22... 12	AWG 26... 10	
800			
8			
	720 A (6 mm ²)		
	3		
	A4 / V2		

Clampable conductors (H05V/H07V)	
Solid / stranded	mm ²
Flexible / flexible w. wire end ferrule	mm ²
Tightening torque range (clamping screw)	Nm
Tightening torque range (fixing screw)	Nm
Stripping length / blade size	mm / -

Rated connection	Additional connection
0.5...6 / 0.5...4	
0.5...4 / 0.5...2.5	
0.4...0.6 (M 2.5)	
0.4...0.6 (M 2.5)	
10 / 3.5 x 0.6	

Rated connection	Additional connection
0.5...6 / 0.5...4	
0.5...4 / 0.5...4	
0.5...1.0 (M 3)	
0.5...1.0 (M 3)	
12 / 3.5 x 0.6	

2 clampable conductors of equal cross-section	
Solid / stranded	mm ²
Flexible / flexible w. wire end ferrule	mm ²

Information

Order data

Version
green/yellow

Type	Qty.	Order No.
EK 2.5/35	100	0661060000

Type	Qty.	Order No.
EK 4/35	100	0661160000

Information

Accessories

--

Rail support

Type	Qty.	Order No.
SH 2	10	0494920000

Type	Qty.	Order No.
SH 2	10	0494920000

Marking systems
DEK 6

Marking systems
DEK 6,5

For detailed information on other accessories and applications see "Accessories"

Modular PE terminals

EK 6/35

6 mm²

EK 10

10 mm²

EK 16

16 mm²

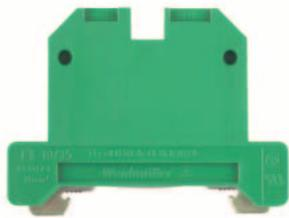

8 x 56.5 x 44
/ 10
0.5 ... 10

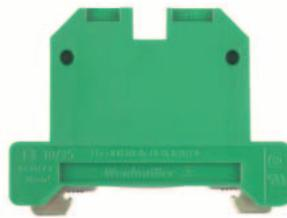
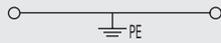

10 x 56 x 44
/ 10
0.5 ... 10

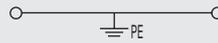

12 x 56 x 50
/ 16
1.5 ... 16

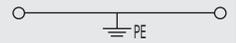

IEC 60947-7-2

IEC	UL	CSA	EN 50019
6	AWG 22... 8	AWG 20... 8	
800			
8			
	720 A (6 mm ²)		
	3		
	A5 / V2		



Rated connection	Additional connection
0.5...10 / 1.5...6	
0.5...10 / 0.5...6	
0.8...1.6 (M 3.5)	
0.5...1.0 (M 3)	
12 / 4.0 x 0.8	

IEC 60947-7-2

IEC	UL	CSA	EN 50019
10	AWG 14... 6	AWG 14... 6	
800			
8			
	1200 A (10 mm ²)		
	3		
	B6 / V2		



Rated connection	Additional connection
0.5...10 / 1.5...6	
0.5...10 / 0.5...10	
1.2...2.4 (M 4)	
0.5...1.0 (M 3)	
12 / 5.5 x 1.0	

IEC 60947-7-2

IEC	UL	CSA	EN 50019
16	AWG 12... 4	AWG 10... 4	
800			
8			
	1920 A (16 mm ²)		
	3		
	B6 / V2		



Rated connection	Additional connection
2.5...16 / 2.5...16	
2.5...16 / 4...16	
2.0...2.4 (M 4)	
0.5...1.0 (M 3)	
16 / 5.5 x 1.0	

Type	Qty.	Order No.
EK 6/35	100	0661260000

Type	Qty.	Order No.
EK 10/35	100	0661360000

Type	Qty.	Order No.
EK 16/35	50	0190160000

Type	Qty.	Order No.
SH 2	10	0494920000

DEK 8

Type	Qty.	Order No.
SH 2	10	0494920000

DEK 5

Type	Qty.	Order No.
SH 2	10	0494920000

DEK 5

Modular PE terminals

TS 35 / PA

EK 35/35

35 mm²

EK 95/35

95 mm²

TS 35 / PA

A

When using ATEX certified components in hazardous area applications the installation instructions and the rated data for accessories in the technical appendix must be considered.

Width/Length/Height with TS35x7.5	mm
Max. current / max. cond. cross-section	A/mm ²
Max. clamping range	mm ²

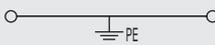
16 x 58 x 60	
/ 50	
2.5 ... 50	

25 x 76.5 x 90.5	
/ 120	
10 ... 120	

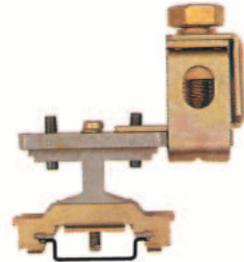

Technical data

Rated data	
Rated cross-section	mm ²
Rated voltage for adjacent terminal	V
Rated impulse voltage / Pollution severity	kV
Short-duration withstand current	A
Pollution severity	
Plug gauge IEC 60-947-1 / flammability class acc. UL 94	
Approvals	

IEC 60947-7-2

IEC	UL	CSA	EN 50019
35	AWG 6... 2	AWG 12... 2	
800			
8			
	4200 A (35 mm ²)		
	3		
	B9 / V2		



IEC 60947-7-2

IEC	UL	CSA	EN 50019
95			
8			
	11400 A (95 mm ²)		
	3		
	B12		

Clampable conductors (H05V/H07V)	
Solid / stranded	mm ²
Flexible / flexible w. wire end ferrule	mm ²
Tightening torque range (clamping screw)	Nm
Tightening torque range (fixing screw)	Nm
Stripping length / blade size	mm / -

Rated connection	Additional connection
6...16 / 16...50	
10...35 / 10...35	
4.0...6.0 (M 6)	
1.2...2.4 (M 4)	
20 / 6.5 x 1.2	

Rated connection	Additional connection
10...16 / 10...95	
16...95 / 10...95	
10...20 (M 10)	
1.2...2.4 (M 4)	
27	

2 clampable conductors of equal cross-section	
Solid / stranded	mm ²
Flexible / flexible w. wire end ferrule	mm ²

Information	
A TS 35x15/2.3 must be used for connecting conductors of 35-50 mm ² .	

Information	
The copper rail TS 35, order No. 0270100000, must be used for fixing.	

Order data

Version
green/yellow

Type	Qty.	Order No.
EK 35/35	20	0661460000

Type	Qty.	Order No.
EK 95/35/1ZB BK	10	0535300000

Information

Accessories

Rail support

Type	Qty.	Order No.
SH 2	10	0494920000

Type	Qty.	Order No.
SH 2	10	0494920000

Marking systems

DEK 5

For detailed information on other accessories and applications see "Accessories"

To fix the terminals use the copper rail TS35 order no. 0270100000.

Modular PE terminals

SAKE 70/35

70 mm²

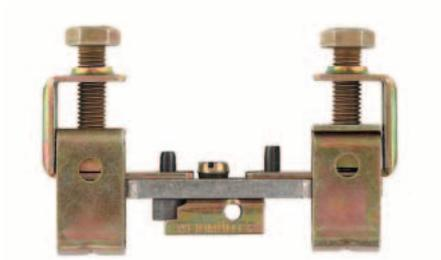

18 x 94 x 59.5
/ 70
10 ... 70

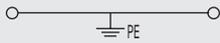

IEC 60947-7-2

IEC	UL	CSA	EN 50019
70			

B10



Rated connection	Additional connection
10...16 / 10...70	
...70 / 10...10	
6.0...12 (M 8)	
2.0...4.0 (M 5)	
25	

A steel TS 35x15/2.3 must be used when connecting conductors of 35-50 mm², and a copper rail for conductors of 70 mm².

Type	Qty.	Order No.
EK 70/35/M.2ZB O.IK	10	1338300000

Type	Qty.	Order No.
SH 2	10	0494920000

For wires with 35 - 50 mm² use the TS 35x15/2.3 in steel and with 70 mm² wires use the TS 35/15/2.3 Cu.

Disconnect terminals

TS 35 / PA

SAKR

4 mm²

SAKR-D

4 mm²

TS 35 / PA

A

When using ATEX certified components in hazardous area applications the installation instructions and the rated data for accessories in the technical appendix must be considered.

Width/Length/Height with TS35x7.5	mm
Max. current / max. cond. cross-section	A/mm ²
Max. clamping range	mm ²

6.5 x 42 x 40.5	
10 / 4	
0.13 ... 4	

6.5 x 46 x 38	
10 / 4	
0.13 ... 4	

Technical data

Rated data	
Rated voltage	V
Rated current	A
Rated cross-section	mm ²
Rated impulse voltage / Pollution severity	kV/-
Plug gauge IEC 60-947-1 / flammability class acc. UL 94	
Approvals	

IEC 60947-7-1 / VDE 0100-537

IEC	UL	CSA	EN 50019
400	300	300	
10	10	10	
4	AWG 26...12	AWG 26...12	
		6 / 3	
		A3 / V2	

IEC 60947-7-1 / VDE 0100-537

IEC	UL	CSA	EN 50019
250	300	300	
10	10	10	
4	AWG 26...12	AWG 22...12	
		6 / 3	
		A3 / V2	

Clampable conductors (H05V/H07V)	
Solid / stranded	mm ²
Flexible / flexible w. wire end ferrule	mm ²
Tightening torque range (clamping screw)	Nm
Stripping length / blade size	mm / -

Rated connection	Additional connection
0.5...4 / 1.5...4	
0.5...4 / 0.5...2.5	
0.5...1.0 (M 3)	
8 / 3.5 x 0.6	

Rated connection	Additional connection
0.5...4 / 1.5...4	
0.5...4 / 0.5...2.5	
0.5...1.0 (M 3)	
8 / 3.5 x 0.6	

2 clampable conductors of equal cross-section	
Solid / stranded	mm ²
Flexible / flexible w. wire end ferrule	mm ²

Information

The tightening torque is 0.5-0.7 Nm for disconnect terminals with sockets.
--

The tightening torque with test sockets is 0.5-0.7 Nm.
--

Order data

Version	
	beige
	blue

Type	Qty.	Order No.
SAKR/35	100	0172160000
SAKR/35 BL	100	0172180000

Type	Qty.	Order No.
SAKRD/35	50	0185760000

Information
SAKR/35 2 StB order No. 0183360000

Accessories

Cross-connection, screwable	
	2-pole
	3-pole
	4-pole
	10-pole
	Connecting sleeve
	Fixing screw
	Fuse cartridges

Type	Current [A]	Qty.	Order No.
QB 2 WI RA6 IS	27	50	0482700000
QB 3 WI RA6 IS	27	50	0482800000
QB 4 WI RA6 IS	27	50	0482900000

Type	Current [A]	Qty.	Order No.
QB 2 WI RA6 IS	27	50	0482700000
QB 3 WI RA6 IS	27	50	0482800000
QB 4 WI RA6 IS	27	50	0482900000

Cross-connection saddle	
	Cross-connection saddle
	Connecting sleeve
	Fixing screw

Socket / Test plug	
	Socket
	Test plug

STB 6/D3.7/2.3/M3 SAKR	100	0379400000
PS 2.3 RT	20	0180400000

STB 6/D3.7/2.3/M3 SAKR	100	0379400000
PS 2.3 RT	20	0180400000

End plate	
	beige
	blue

Width [mm]	
AP SAKR BE	1.5 20 0211360000
AP SAKR BL	1.5 20 0211380000

Width [mm]	
AP SAKR BE	1.5 20 0211360000
AP SAKR BL	1.5 20 0211380000

Partition / Partition disc	
	beige
	blue
	Partition disc

Cover / fixing screw (plastic)	
	Cover
	Fixing screw (plastic)

Marking systems	
	DEK 6,5

	DEK 6,5
--	---------

	DEK 6,5
--	---------

Detailed information on all versions in chapter accessories.	
	QB 25 blank, see chapter accessories. To use twin ferrules ZH 0,5 to ZH 1,5 is possible.

	QB 25 blank, see chapter accessories. To use twin ferrules ZH 0,5 to ZH 1,5 is possible.
--	--

	twin ferrule ZH 0,5 to ZH 1,5 useable.
--	--

Disconnect terminals

DKT 4

4 mm²

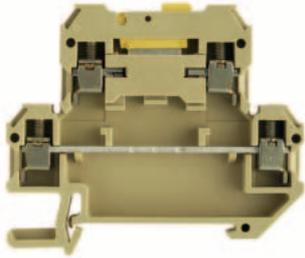

6 x 65 x 56.5
10 / 4
0.13 ... 4



IEC 60947-7-1 / VDE 0100-537

IEC	UL	CSA	EN 50019
400	300	300	
10	10	10	
4	AWG 22...12	AWG 26...12	
	6 / 3		
	A3 / V2		



Rated connection	Additional connection
0.5...4 / 1.5...4	
0.5...4 / 0.5...2.5	
0.5...1.0 (M 3)	
9 / 3.5 x 0.6	

The tightening torque with sockets is 0.5-0.7 Nm.

Type	Qty.	Order No.
DKT 4/35	100	0687460000

DKT 4/35 2 StB Order No. 0327960000

Type	Current [A]	Qty.	Order No.
QB 2 WI RA6 IS	27	50	0482700000
QB 3 WI RA6 IS	27	50	0482800000
QB 4 WI RA6 IS	27	50	0482900000

PS 2.3 RT	20	0180400000
Width [mm]		
AP DKT4 PA	1.5	0687560000
Width [mm]		

DEK 6

DKT 4 V

4 mm²



6 x 65 x 56.5
10 / 4
0.13 ... 4

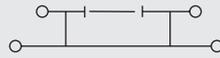

IEC 60947-7-1 / VDE 0100-537

IEC	UL	CSA	EN 50019
400			
10			
4			
	6 / 3		
	A3 / V2		

Rated connection	Additional connection
0.5...4 / 1.5...4	
0.5...4 / 0.5...2.5	
0.5...1.0 (M 3)	
9 / 3.5 x 0.6	

The tightening torque with sockets is 0.5-0.7 Nm.

Type	Qty.	Order No.
DKT 4V/35 2STB	100	1304960000

Type	Current [A]	Qty.	Order No.
QB 2 WI RA6 IS	27	50	0482700000
QB 3 WI RA6 IS	27	50	0482800000
QB 4 WI RA6 IS	27	50	0482900000

PS 2.3 RT	20	0180400000
Width [mm]		
AP DKT4 PA	1.5	0687560000
Width [mm]		

DEK 6

Disconnect terminals

TS 35 / KrG

SAKC 4/35

4 mm²

SAKC 10/35

10 mm²

TS 35 / KrG

A

When using ATEX certified components in hazardous area applications the installation instructions and the rated data for accessories in the technical appendix must be considered.

Width/Length/Height with TS35x7.5	mm
Max. current / max. cond. cross-section	A/mm ²
Max. clamping range	mm ²

6.5 x 49.5 x 59.5	
25 / 6	
0.33 ... 6	

12 x 65 x 48.5	
27 / 10	
0.5 ... 10	

Technical data

Rated data	
Rated voltage	V
Rated current	A
Rated cross-section	mm ²
Rated impulse voltage / Pollution severity	kV/-
Plug gauge IEC 60-947-1 / flammability class acc. UL 94	
Approvals	

IEC 60947-7-1

IEC	UL	CSA	EN 50019
400	300	300	
25	25	25	
4	AWG 22...12	AWG 22...10	
6 / 3			
A4 / 5VA			

IEC 60947-7-1

IEC	UL	CSA	EN 50019
500	300	600	
27	25	25	
10	AWG 22...8	AWG 20...10	
6 / 3			
B6 / 5VA			

Clampable conductors (H05V/H07V)	
Solid / stranded	mm ²
Flexible / flexible w. wire end ferrule	mm ²
Tightening torque range (clamping screw)	Nm
Stripping length / blade size	mm / -

Rated connection	Additional connection
0.5...6 / 1.5...4	
0.5...4 / 0.5...4	
0.5...1.0 (M3)	
12 / 3.5 x 0.6	

Rated connection	Additional connection
0.5...10 / 1.5...10	
0.5...10 / 0.5...10	
1.2...2.4 (M4)	
12 / 5.5 x 1.0	

2 clampable conductors of equal cross-section	
Solid / stranded	mm ²
Flexible / flexible w. wire end ferrule	mm ²

Information

Information
Tightening torque for the test sockets 0.5 ... 0.7 Nm

Information
Tightening torque for the test sockets 1.2 Nm. Tightening torque for 10 mm ² stranded with 1.6 Nm.

Order data

Version	
yellow	
blue	

Type	Qty.	Order No.
SAKC 4/35	100	0357520000
SAKC 4/35 BL	100	0357570000

Type	Qty.	Order No.
SAKC 10/35 1STB4 KRG	50	1404520000

Information
SAKC 4/35 2 StB Order No. 0340620000

Information
SAKC 10/35 2 StB4 Order No. 1404620000

Accessories

Cross-connection, screwable	
2-pole	
3-pole	
4-pole	
10-pole	
Connecting sleeve	
Fixing screw	
Fuse cartridges	

Type	Current [A]	Qty.	Order No.
QB 2 WI RA6 IS	27	50	0482700000
QB 3 WI RA6 IS	27	50	0482800000
QB 4 WI RA6 IS	27	50	0482900000

Type	Current [A]	Qty.	Order No.
QL 2 SAKA10	36	50	0135500000
QL 3 SAKA10	36	50	0135600000
QL 4 SAKA10	36	50	0135700000
QL 10 SAKA10	36	20	0338500000
VH 13.6/7/4.2 SAKA10		50	0299700000
BFSC M4X20		100	0362800000
SS M4 D 128-A 4		100	0136400000

Cross-connection saddle	
Cross-connection saddle	
Connecting sleeve	
Fixing screw	

Type	Qty.	Order No.

Type	Qty.	Order No.
VH 13.6/7/4.2 SAKA10	50	0299700000

Socket / Test plug	
Socket	
Test plug	

Type	Qty.	Order No.
PS 2.3 RT	20	0180400000

Type	Qty.	Order No.
STB 17/D6/4/M4 SAKC10	50	0147100000
PS 4 F.STB 4	20	0299600000

End plate	
yellow	
blue	

Width [mm]		Qty.	Order No.
AP SAK4-10 KRG	1.5	20	0117920000
AP SAK4-10 KRG/BL	1.5	20	0117970000

Width [mm]		Qty.	Order No.
AP SAKB/C/T KRG	3	20	0146720000

Partition / Partition disc	
yellow	
blue	
Partition disc	

Width [mm]		Qty.	Order No.
TW SAK4-10 KRG	2.5	20	0130120000
TW SAK4-10 KRG/BL	2.5	20	0130170000

Width [mm]		Qty.	Order No.
TW SAKB-C-T	3	20	0242920000

Cover / fixing screw (plastic)	
Cover	
Fixing screw (plastic)	

Type	Qty.	Order No.

Type	Qty.	Order No.

Marking systems	
DEK 6,5	

Type	Qty.	Order No.
Dummy plug and pull out tool see chapter accessories		

Type	Qty.	Order No.
Pull out force lock under Accessories.		

Fuse terminals

SAKS 1/35 5x25

10 mm²

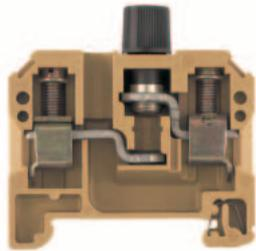

13 x 54 x 61
10 / 16
0.13 ... 16

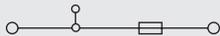

IEC	UL	CSA	EN 50019
500	300	600	
10	6.3	10	
10	AWG 22... 10	AWG 26... 10	
	6 / 3		
	B6 / 5VA		



Rated connection

0.5...16 / 1.5...10
0.5...10 / 0.5...10
1.2...2.4 (M 4)
12 / 5.5 x 1.0

SAKS 1/35 5x25

10 mm²

With Neon Bulb



13 x 54 x 61
6.3 / 16
0.5 ... 16



IEC	UL	CSA	EN 50019
6.3			
10			
	4		
	B6 / 5VA		



Rated connection

0.5...16 / 1.5...10
0.5...10 / 0.5...10
1.2...2.4 (M 4)
12 / 5.5 x 1.0

SAKS 3/35

10 mm²

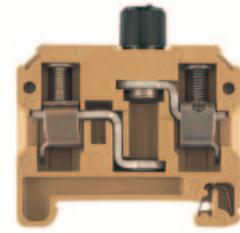

13 x 54 x 61
10 / 16
0.33 ... 16



IEC	UL	CSA	EN 50019
500	300	600	
10	10	10	
10	AWG 22... 10	AWG 22... 10	
	6 / 3		
	B6 / 5VA		



Rated connection

0.5...16 / 1.5...10
0.5...10 / 0.5...10
1.2...2.4 (M 4)
12 / 5.5 x 1.0

Type	Qty.	Order No.
SAKS 1/35/G25	20	0501520000

Type	Qty.	Order No.
SAKS 1/35 G25 GL 230VAC	10	0198620000

Type	Qty.	Order No.
SAKS 3/35 G/5X30 500V	20	0328920000

SAKS 3/35 GZ/6.3X32	20	0667520000
SAKS 3 1"x1/4" with a red cap available under 0667420000.		

Type	Current [A]	Qty.	Order No.
QL 2 SAKS1	47	50	0191400000
QL 3 SAKS1	36	50	0191500000
QL 4 SAKS1	36	20	0191600000
QL 10 SAKS1	36	20	0338800000
Width [mm]			
AP SAKS1+3 KRG	3	20	0191320000

Type	Current [A]	Qty.	Order No.
AP SAKS1+3 KRG	3	20	0191320000

Type	Current [A]	Qty.	Order No.
AP SAKS1+3 KRG	3	20	0191320000

DEK 5

Use the cross connection with a screw M3 x 6 mm with order no. 0346200000.

DEK 5

DEK 5

Fuse terminals

TS 35 / KrG

SAKS 2/35

10 mm²

SAKS 4/35

10 mm²

D 01-fuses

When using ATEX certified components in hazardous area applications the installation instructions and the rated data for accessories in the technical appendix must be considered.

Width/Length/Height with TS35x7.5	mm
Max. current / max. cond. cross-section	A/mm ²
Max. clamping range	mm ²

27.6 x 80 x 75
10 / 16
0.33 ... 16

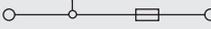

24 x 75 x 66
16 / 16
0.33 ... 16

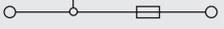

Technical data

Rated data	
Rated voltage for adjacent terminal	V
Rated current	A
Rated cross-section	mm ²
Rated impulse voltage / Pollution severity	kV/-
Plug gauge IEC 60-947-1 / flammability class acc. UL 94	
Approvals	
Clamped conductor (H05V/H07V)	
Solid / stranded	mm ²
Flexible / flexible w. wire end ferrule	mm ²
Tightening torque range (clamping screw)	Nm
Stripping length / blade size	mm / -
2 clampable conductors of equal cross-section	
Solid / stranded	mm ²
Flexible / flexible w. wire end ferrule	mm ²
Information	

IEC 60947-7-3 / VDE 0611-6

IEC	UL	CSA	EN 50019
500		600	
10		25	
10		AWG 22... 8	
		6 / 3	
		B6 / 5VA	



Rated connection	Additional connection
0.5...16 / 0.5...10	
0.5...10 / 0.5...10	
1.2...2.4 (M 4)	
12 / 5.5 x 1.0	

For short-circuit use up to 25A.

IEC 60947-7-3 / VDE 0611-6

IEC	UL	CSA	EN 50019
400	600	600	
16	30	30	
10	AWG 22... 8	AWG 22... 8	
	6 / 3		
	B6 / 5VA		



Rated connection
0.5...16 / 1.5...10
0.5...10 / 0.5...10
1.2...2.4 (M 4)
14 / 5.5 x 1.0

Tightening torque 1.6 Nm for 10 mm² stranded wire.

Order data

Version	
without LED	
Information	

Type	Qty.	Order No.
SAKS 2/35	20	1368720000
Information		

Type	Qty.	Order No.
SAKS 4/35	20	0501820000
Information		

Accessories

Cross-connection	
	2-pole
	3-pole
	4-pole
	10-pole
	Fuse cartridges
	Fixing screw
Screw cap	
	SK
	SK
Gauge pieces	
Fuse cartridges	
Rated voltage 500V	
Fuse cartridges	
Rated voltage 400V	
Marking systems	
For detailed information on other accessories and applications see "Accessories"	

Type	Current [A]	Qty.	Order No.
QL 2 SAKS2	47	20	0207800000
QL 3 SAKS2	36	20	0207900000
QL 4 SAKS2	36	20	0208000000
QL 10 SAKS2	36	20	0338900000
SS M4 D 128-A 4		100	0136400000
BFSC M4X9T		100	0103300000
Colour			
SK E16/SAKS2	black	25	0284110000
Colour			
P 16/16 GR SAKS2	grey	100	0209000000
P 16/20 BL SAKS2	blue	100	0209100000
Colour			
E 16/10A RT TNDZ		25	0208500000
E 16/16A GR TNDZ		25	0208600000
E 16/20A BL TNDZ		25	0208700000
E 16/25A GE TNDZ		25	0208800000
Colour			
E 14/10A RT		10	0328400000
E 14/16A GR		10	0328500000
E 14/4A RS		10	0137400000
E 14/4A BR		10	0137500000
Colour			
DEK 5			

Type	Current [A]	Qty.	Order No.
QL 2 SAKS4	47	20	0328000000
QL 3 SAKS4	36	20	0328100000
QL 4 SAKS4	36	20	0328200000
QL 10 SAKS4	36	20	0339000000
SS M4 D 128-A 4		100	0136400000
BFSC M4X9T		100	0103300000
Colour			
SK E14 SAKS4	black	20	0339410000
Colour			
P 14/2 D01 RS SAKS4	pink	50	0138000000
P 14/4 D01 BR SAKS4	brown	50	0138100000
P 14/10 D01 RT SAKS4	red	50	0328700000
P 14/6 D01 GN SAKS4	green	50	0328600000
Colour			
E 14/10A RT		10	0328400000
E 14/16A GR		10	0328500000
E 14/4A RS		10	0137400000
E 14/4A BR		10	0137500000
Colour			
DEK 5			

Fuse terminals

SAKS 4/35 USA

10 mm²

1 1/4 x 1/4



24 x 75 x 73
30 / 16
0.5 ... 16



IEC	UL	CSA	EN 50019
400	600	600	
30	30	30	
10	AWG 20... 8	AWG 22... 8	
	6 / 3		
	B6 / 5VA		



Rated connection

0.5...16 / 1.5...10
0.5...10 / 0.5...10
1.2...2.4 (M 4)
14 / 5.5 x 1.0

Tightening torque 1.6 Nm for 10 mm² stranded wire.

Type	Qty.	Order No.
SAKS 4/35 USA	20	0178220000

SAKS 5/35

16 mm²

D 02 - fuse

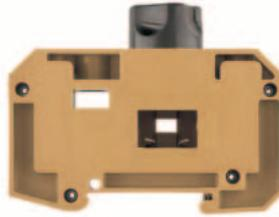

28 x 80 x 66
63 / 16
1.5 ... 16



IEC 60947-7-3 / VDE 0611-6

IEC	UL	CSA	EN 50019
400	600	600	
63	40	63	
16	AWG 14... 6	AWG 14... 6	
	6 / 3		
	B7 / 5VA		



Rated connection

1.5...16 / 1.5...16
1.5...16 / 1.5...16
1.2...2.4 (M 4)
13 / 5.5 x 1.0

Tightening torque 1.6 Nm for 10 mm² stranded wire.

Type	Qty.	Order No.
SAKS 5/35	20	0502120000

Type	Current [A]	Qty.	Order No.
QL 2 SAKS4	47	20	0328000000
QL 3 SAKS4	36	20	0328100000
QL 4 SAKS4	36	20	0328200000
QL 10 SAKS4	36	20	0339000000
SS M4 D 128-A 4		100	0136400000
BFSC M4X9T		100	0103300000
Colour			
SK E14 SAKS4 USA	black	1	2012790000

Colour

DEK 5

Type	Current [A]	Qty.	Order No.
QL 2 SAKS2	47	20	0207800000
QL 3 SAKS2	36	20	0207900000
QL 4 SAKS2	36	20	0208000000
QL 10 SAKS2	36	20	0338900000
SS M4 D 128-A 4		100	0136400000
BFSC M4X9T		100	0103300000
Colour			
SK E18 SAKS5	black	20	0359310000

Colour

P 18/20 D02 BL SAKS5	blue	50	0361800000
P 18/25 D02 GE SAKS5	yellow	50	0361900000
P 18/35 D02 SW SAKS5	black	50	0362000000
P 18/50 D02 WS SAKS5	white	50	0362100000

E 18/20A BL	10	0361300000
E 18/25A GE	10	0361400000
E 18/50A WS	10	0361600000
E 18/63A KU	10	0361700000

DEK 5

Partition plate TW HP (2.0) order No. 0607000000, for TS 32 only

Fuse inserts and gauge rings for Weidmüller fuse terminals

Fuse inserts

Technical data

for terminal type

SAKS 1
SAKS 7
ASK 1
WSI 6



G fuse inserts 5 x 20 without indicator acc. to IEC 60127-2 (VDE 0820 T.2 BI 1)

Size (mm)	Rated voltage (V)	Rated current (A)	Type
5 x 20 Breaking capacity 1500 A (at 250 V, 50 Hz, cos φ 0,7)	250	0.1	(F) G 20/0.10A/F
		0.2	(F) G 20/0.20A/F
		0.25	(F) G 20/0.25A/F
		0.5	(F) G 20/0.50A/F
		0.63	(F) G 20/0.63A/F
		1.0	(F) G 20/1.00A/F
		1.6	(F) G 20/1.60A/F
		2.0	(F) G 20/2.00A/F
		2.5	(F) G 20/2.50A/F
		3.15	(F) G 20/3.15A/F
		4.0	(F) G 20/4.00A/F
		5.0	(F) G 20/5.00A/F
		6.3	(F) G 20/6.30A/F

(M) = medium-delayed action (F) = fast

Order data

Qty.	Order No.
10	0430300000
10	0430400000
10	0430500000
10	0430600000
10	0439000000
10	0430700000
10	0430800000
10	0430900000
10	0431000000
10	0431100000
10	0431200000
10	0431300000
10	0431400000

SAKS 1
SAKS 7
WSI 6



G fuse inserts 5 x 25 with indicator acc. to DIN 41576¹⁾

Size (mm)	Rated voltage (V)	Rated current (A)	Type
5 x 25 m. K.) Breaking capacity 80 A (at 250 V, 50 Hz, cos φ = 1)	250	0.25	(M) G 25/0.25A/M
		0.5	(M) G 25/0.50A/M
		0.8	(M) G 25/0.80A/M
		1	(M) G 25/1.00A/M
		10	(M) ²⁾ G 25/10.0A/M
		2	(F) G 25/2.00A/F
		4	(F) G 25/4.00A/F
		6.3	(F) G 25/6.30A/F

(M) = medium-delayed action (F) = fast

SAKS 3³⁾
SAKS 6



Fuse inserts 1 1/4" x 1/4" without indicator acc. to BS 88

Rated current (A)	Rated voltage (V)	Rated current (A)	Type
33 kA Breaking capacity 33 kA fast	440	0.5	GZ 0.5A/F
		1	GZ 1.0A/F
		2	GZ 2.0A
		3	GZ 3.0A
		5	GZ 5.0A
		7	GZ 7.0A
		10	GZ 10.0A
		12.5	GZ 12.5A FF

(F) = fast (M) = medium-delayed action

SAKS 2



D fuse inserts E 16 with indicator acc. to DIN 49360 (diazed)

Rated current (A)	Rated voltage (V)	Rated current (A)	Type
E 10 A E 16 A E 20 A E 25 A	500	10	E 16/10A RT
		16	E 16/16A GR
		20	E 16/20A BL
		25	E 16/25A GE

(F) = fast (M) = medium-delayed action

SAKS 4⁴⁾



D fuse inserts E 14 size D 01 and E 18 size D 02 with indicator acc. to DIN 49522 (neozed)⁵⁾

Rated current (A)	Rated voltage (V)	Rated current (A)	Type
E 14/2 E 14/4 E 14/6 E 14/10 E 14/16	400	2	E 14/2A RS
		4	E 14/4A BR
		6	E 14/6A GN
		10	E 14/10A RT
		16	E 14/16A GR
		E 18/20 E 18/25 E 18/35 E 18/50 E 18/63	400
25	E 18/25A GE		
35	E 18/35A SW		
50	E 18/50A WS		
63	E 18/63A KU		

(F) = fast (M) = medium-delayed action

Note: ¹⁾ The SIBA company also supplies 5 x 25 G fuse inserts with indicators in a shipbuilding model for 450 V AC.
²⁾ 5 x 30 (500 V AC) fuse inserts for SAKS 3 are available from the WICKMANN company
³⁾ The LINDNER company also supplies neozed fuse cartridges in an additional shipbuilding mode for 440 V AC.
⁴⁾ Fuse cartridges with the dimensions 1"x1/4" ≅ 25.4x6.35 mm and 13/32"x1/4" ≅ 10.3x38.1 mm are not included in product line.
⁵⁾ Only for SAKS 1 and SAKS 7.

Fuse inserts and gauge rings for Weidmüller fuse terminals

Gauge rings

Technical data

For terminal type

SAKS 4 and 4/35



Gauge ring type

Gauge ring type	Amp.	Colour	Typ
P 14/2	2	Pink	P 14/2D01 RS
P 14/4	4	Brown	P 14/4D01 BR
P 14/6	6	Green	P 14/6D01 GN
P 14/1	10	Red	P 14/10D01 RT

Order data

Qty.	Order No.
50	0138000000
50	0138100000
50	0328600000
50	0328700000

SAKS 5 and 5/35



P 18/20	20	Blue	P 18/20D02 BL
P 18/25	25	Yellow	P 18/25D02 GE
P 18/35	35	Black	P 18/35D02 SW
P 18/50	50	White	P 18/50D02 WS

50	0361800000
50	0361900000
50	0362000000
50	0362100000

SAKS 2 and 2/35



P 16/10	10	Red	P 16/10 RT
P 16/16	16	Grey	P 16/16 GR
P 16/20	20	Blue	P 16/20 BL

100	0208900000
100	0209000000
100	0209100000

Installation terminals

TS 35 / PA

This NT-terminals are used for isolated measurement without the disconnection of the wire.

When using ATEX certified components in hazardous area applications the installation instructions and the rated data for accessories in the technical appendix must be considered.

Width/Length/Height with TS35x7.5	mm
Max. current / max. cond. cross-section	A/mm ²
Max. clamping range	mm ²

Technical data

Rated data	
Rated voltage	V
Rated current	A
Rated cross-section	mm ²
Rated impulse voltage / Pollution severity	kV/-
Plug gauge IEC 60-947-1 / flammability class acc. UL 94	
Approvals	
Clampable conductors (H05V/H07V)	
Solid / stranded	mm ²
Flexible / flexible w. wire end ferrule	mm ²
Stripping length / blade size	mm / -
Tightening torque range (clamping screw)	Nm

Information

Order data

Version	Information
dark beige	
blue	

Accessories

Cross-connection	Information
2-pole	
3-pole	
4-pole	
10-pole	

End plate / partition	Information
beige	
blue	

Mounting plate for 10 x 3 (reqd. every 20 cm)	Information
blue	
for vertical mounting position	

Busbar 10 x 3 (140A)	Information
Lower edge busbar to upper edge TS35 = 25.5mm	

Tension clamp for feeding 10 x 3 busbars	Information
Rigid / flexible 0.5 - 6 / 4mm ²	
Rigid / flexible 6 - 16mm ²	
Standard version	



(ZB16)

Marking systems

Detailed information on all versions in chapter accessories.

NT 2.5/35

2.5 mm²

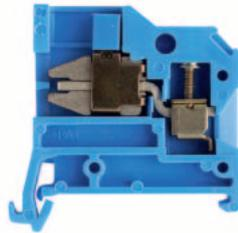

6 x 45 x 44	
24 / 4	
0.33 ... 4	

IEC 60947-7-1 / VDE 0611-4

IEC	UL	CSA	EN 50019
400	300	300	
24	20	25	
2.5	AWG 22... 12	AWG 22... 12	
		6 / 3	
		A3 / V2	



Rated connection

0.5...4 / 0.5...4
0.5...2.5 / 0.5...2.5
10 / 0.6 x 3.5
0.5...0.8 (M 2.5)

Tightening torque for the disconnect clamp 0.5 ... 0.8 Nm.

NT 6/35 (KrG)

6 mm²

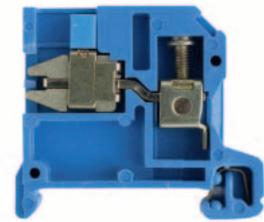

8 x 49 x 44	
41 / 10	
0.5 ... 10	

IEC 60947-7-1 / VDE 0611-4

IEC	UL	CSA	EN 50019
400	300	300	
41	40	40	
6	AWG 22... 8	AWG 20... 10	
		6 / 3	
		A5 / 5VA	



Rated connection

0.5...10 / 0.5...10
0.5...10 / 0.5...6
12 / 0.8 x 4
0.8...1.4 Nm (M 3.5)

Tightening torque for the disconnect clamp 0.5 ... 0.8 Nm.

Type	Qty.	Order No.
NT 2.5/35 10X3 BL	100	0471780000

Type	Current [A]	Qty.	Order No.

Width [mm]	Information

Width [mm]	Information
HP NT2.5 BL	1.5 20 0352080000

Width [mm]	Information
SSCH 10X3X1000 CU/SN	1 0348900000

Width [mm]	Information
ZB 4	5.6 50 0316500000
ZB 16 ZKSC	50 0316600000
ZB 35/M6X16	20 0266500000

Marking systems

DEK 6

PEN-bridge and additional clamping yoke variants see chapter accessories. To use twin ferrules on request.

Type	Qty.	Order No.
NT 6/35 10X3 KR/BL	100	0501470000

Type	Current [A]	Qty.	Order No.

Width [mm]	Information

Width [mm]	Information
HP NT6/10 BL	1.5 20 0352880000

Width [mm]	Information
SSCH 10X3X1000 CU/SN	1 0348900000

Width [mm]	Information
ZB 4	5.6 50 0316500000
ZB 16 ZKSC	50 0316600000
ZB 35/M6X16	20 0266500000

Marking systems

DEK 6

PEN-bridge and additional clamping yoke variants see chapter accessories. To use twin ferrules on request.

Installation terminals

NT 10/35

10 mm²

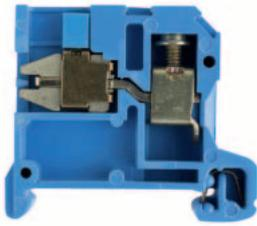

10 x 45 x 44
57 / 16
0.5 ... 16

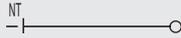

IEC 60947-7-1 / VDE 0611-4

IEC	UL	CSA	EN 50019
400	300	300	
57	50	50	
10	AWG 14... 8	AWG 14... 8	
	6 / 3		
	B6 / V2		



Rated connection

0.5...16 / 0.5...10
0.5...10 / 0.5...10
12 / 5.5 x 1.0
1.2...1.6 Nm (M 4)

0.5...0.8 Nm tightening torque via disconnecter 10 mm² multistrand conductor tightened with 1.6 Nm

NT 16/35

16 mm²

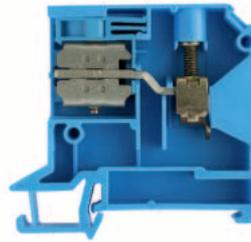

12 x 59.5 x 58
76 / 16
2.5 ... 16

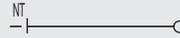

IEC 60947-7-1 / VDE 0611-4

IEC	UL	CSA	EN 50019
400	300	300	
76	65	70	
16	AWG 16... 6	AWG 12... 6	
	6 / 3		
	B6 / V2		



Rated connection

2.5...16 / 2.5...10
2.5...16 / 2.5
12 / 5.5 x 1.0
1.2...1.6 Nm (M 4)

Tightening torque for the disconnect lever 0.8 ... 1.4 Nm. Tightening torque for 10 and 16 mm² stranded with 1.6 Nm.

Type	Qty.	Order No.
NT 10/35 10X3 BL	50	0471880000

Type	Qty.	Order No.
NT 16/35 10X3 BL	50	0499280000

Type	Current [A]	Qty.	Order No.
Width [mm]			
Width [mm]			
HP NT6/10 BL	1.5	20	0352880000
Width [mm]			
SSCH 10X3X1000 CU/SN		1	0348900000
Width [mm]			
ZB 4	5.6	50	0316500000
ZB 16 ZKSC		50	0316600000
ZB 35/M6X16		20	0266500000

Type	Current [A]	Qty.	Order No.
Width [mm]			
Width [mm]			
HP NT16/10X3	2	20	1266380000
Width [mm]			
SSCH 10X3X1000 CU/SN		1	0348900000
Width [mm]			
ZB 4	5.6	50	0316500000
ZB 16 ZKSC		50	0316600000
ZB 35/M6X16		20	0266500000

DEK 6

For PEN jumpers and other cable grip variations see the Accessories section. Use of twin wire end ferrules on request.

DEK 5

PEN-bridge and additional clamping yoke variants see chapter accessories. To use twin ferrules on request.

Modular disconnect test terminals

TS 35 / KrG

SAKT 1/LT

6 mm²

SAKT 1/DU1

6 mm²

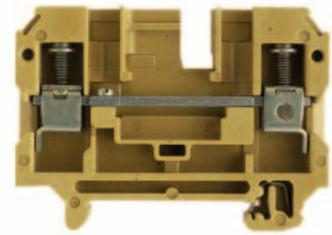
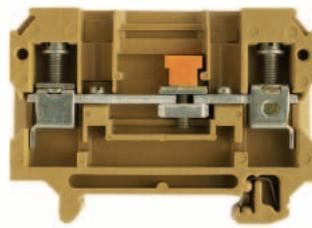

When using ATEX certified components in hazardous area applications the installation instructions and the rated data for accessories in the technical appendix must be considered.

Width/Length/Height with TS35x7.5	mm
Max. current / max. cond. cross-section	A/mm ²
Max. clamping range	mm ²

8 x 65 x 52.5
57 / 10
0.13 ... 10

8 x 65 x 52.5
57 / 10
0.13 ... 10

Technical data

Rated data	
Rated voltage	V
Rated current	A
Rated cross-section	mm ²
Rated impulse voltage / Pollution severity	kV/-
Plug gauge IEC 60-947-1 / flammability class acc. UL 94	
Approvals	
Clampable conductors (H05V/H07V)	
Solid / stranded	mm ²
Flexible / flexible w. wire end ferrule	mm ²
Tightening torque range (clamping screw)	Nm
Tightening torque range disconnecter	Nm
Stripping length / blade size	mm / -
Information	

IEC 60947-7-1

IEC	UL	CSA	EN 50019
400	300	300	
41	25	25	
6	AWG 26... 8	AWG 26... 8	
		6 / 3	
		A5 / 5VA	

Rated connection **Additional connection**

0.5...10 / 1.5...10	
0.5...6 / 0.5...6	
0.8...1.6 (M 3.5)	
0.5...0.8	
12 / 4.0 x 0.8	

IEC 60947-7-1

IEC	UL	CSA	EN 50019
400	300	300	
41	25	25	
6	AWG 26... 8	AWG 26... 8	
		6 / 3	
		A5 / 5VA	

Rated connection **Additional connection**

0.5...10 / 1.5...10	
0.5...6 / 0.5...8	
0.8...1.6 (M 3.5)	
12 / 4.0 x 0.8	

Tightening torque 1.6 Nm for 10 mm² stranded wire.

Order data

Version	
Without socket	
with open back for cross-connection	
with 1 socket	
with 2 sockets	
with 4 sockets	
Information	

Type	Qty.	Order No.
SAKT 1/35/LT	50	0105420000
SAKT 1/35/LT STB	50	0105620000

Type	Qty.	Order No.
SAKT 1/35/DU1	50	0105820000

Accessories

Type	Current [A]	Qty.	Order No.
QL 2 SAK6N	57	50	0194300000
QL 3 SAK6N	57	50	0194400000
QL 4 SAK6N	57	50	0194500000
QL 10 SAK6N	57	20	0338300000
VH 12/4.9/3.3 SAK6N		100	0249000000
KISC M3X20 SAK10 CU5		100	0377100000
Width [mm]			
AP SAKB/C/T KRG	3	20	0146720000
TW SAKB/C/T1	1.5	20	0242960000
TSCH 2	0.6	100	0353660000
Cross-connection slider			
QVS 2 SAKT1+2		20	0307300000
QVS 3 SAKT1+2		20	0329300000
QVS 4 SAKT1+2		20	0307400000
VH 19/6/4.2 SAKT1		50	0318000000
BS 25 O.IH SAKT1		50	0334700000
Testing/Checking			
PS 4 F.STB 4		20	0299600000
STB 14/D6/4/M3 SAK10		50	0169900000
Other accessories			
SSP 3 SAKT1		100	0531760000
QS 2/8/4		20	0270960000
Marking systems			
DEK 6,5			

For detailed information on other accessories and applications see "Accessories"

Type	Current [A]	Qty.	Order No.
QL 2 SAK6N	57	50	0194300000
QL 3 SAK6N	57	50	0194400000
QL 4 SAK6N	57	50	0194500000
QL 10 SAK6N	57	20	0338300000
VH 12/4.9/3.3 SAK6N		100	0249000000
KISC M3X20 SAK10 CU5		100	0377100000
Width [mm]			
AP SAKB/C/T KRG	3	20	0146720000
TW SAKB/C/T1	1.5	20	0242960000
TSCH 2	0.6	100	0353660000
Cross-connection slider			
QVS 2 SAKT1+2		20	0307300000
QVS 3 SAKT1+2		20	0329300000
QVS 4 SAKT1+2		20	0307400000
VH 19/6/4.2 SAKT1		50	0318000000
BS 25 O.IH SAKT1		50	0334700000
Testing/Checking			
PS 4 F.STB 4		20	0299600000
STB 14/D6/4/M3 SAK10		50	0169900000
Other accessories			
SSP 3 SAKT1		100	0531760000
QS 2/8/4		20	0270960000
Marking systems			
DEK 6,5			

To safe the test sockets use the SD-blade or bits with pilots!

Type	Current [A]	Qty.	Order No.
QL 2 SAK6N	57	50	0194300000
QL 3 SAK6N	57	50	0194400000
QL 4 SAK6N	57	50	0194500000
QL 10 SAK6N	57	20	0338300000
VH 12/4.9/3.3 SAK6N		100	0249000000
KISC M3X20 SAK10 CU5		100	0377100000
Width [mm]			
AP SAKB/C/T KRG	3	20	0146720000
TW SAKB/C/T1	1.5	20	0242960000
TSCH 2	0.6	100	0353660000
Cross-connection slider			
QVS 2 SAKT1+2		20	0307300000
QVS 3 SAKT1+2		20	0329300000
QVS 4 SAKT1+2		20	0307400000
VH 19/6/4.2 SAKT1		50	0318000000
BS 25 O.IH SAKT1		50	0334700000
Testing/Checking			
PS 4 F.STB 4		20	0299600000
STB 14/D6/4/M3 SAK10		50	0169900000
Other accessories			
SSP 3 SAKT1		100	0531760000
QS 2/8/4		20	0270960000
Marking systems			
DEK 6,5			

To safe the test sockets use the SD-blade or bits with pilots!

Modular disconnect test terminals

SAKT 1/QT

6 mm²

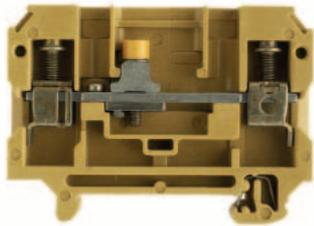

8 x 65 x 52.5
57 / 10
0.13 ... 10



IEC 60947-7-1

IEC	UL	CSA	EN 50019
400	300	300	
41	25	25	
6	AWG 26... 8	AWG 26... 8	
	6 / 3		
	A5 / 5VA		



Rated connection	Additional connection
0.5...10 / 1.5...10	
0.5...6 / 0.5...6	
0.8...1.6 (M 3.5)	
0.5...0.8	
12 / 4.0 x 0.8	

Tightening torque 1.6 Nm for 10 mm² stranded wire.

Type	Qty.	Order No.
SAKT 1/35/QT2	50	0124620000
SAKT 1/35/QT1	50	0105720000

Type	Current [A]	Qty.	Order No.
QL 2 SAK6N	57	50	0194300000
QL 3 SAK6N	57	50	0194400000
QL 4 SAK6N	57	50	0194500000
QL 10 SAK6N	57	20	0338300000
VH 12/4.9/3.3 SAK6N		100	0249000000
KISC M3X20 SAK10 CU5		100	0377100000
Width [mm]			
AP SAKB/C/T KRG	3	20	0146720000
TW SAKB/C/T1	1.5	20	0242960000
TSCH 2	0.6	100	0353660000
QVS 2 SAKT1+2		20	0307300000
QVS 3 SAKT1+2		20	0329300000
QVS 4 SAKT1+2		20	0307400000
VH 19/6/4.2 SAKT1		50	0318000000
BS 25 O.IH SAKT1		50	0334700000
PS 4 F.STB 4		20	0299600000
STB 14/D6/4/M3 SAK10		50	0169900000

SSP 3 SAKT1	100	0531760000
QS 2/8/4	20	0270960000

DEK 6,5

To safe the test sockets use the SD-blade or bits with pilots!

SAKT 2/LT

6 mm²

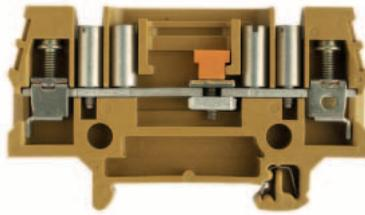

8 x 82 x 52.5
46 / 10
0.5 ... 10

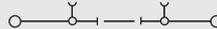

IEC 60947-7-1

IEC	UL	CSA	EN 50019
400	300	300	
41	25	25	
6	AWG 22... 8	AWG 26... 8	
	6 / 3		
	A5 / 5VA		



Rated connection	Additional connection
0.5...10 / 1.5...6	
0.5...6 / 0.5...6	
0.8...1.6 (M 3.5)	
0.5...0.8	
12 / 4.0 x 0.8	

Tightening torque 1.6 Nm for 10 mm² stranded wire.

Type	Qty.	Order No.
SAKT 2/35/LT/STB	50	0105920000
SAKT 2/35/LT 4STB	50	0106020000

Type	Current [A]	Qty.	Order No.
QL 2 SAK6N	57	50	0194300000
QL 3 SAK6N	57	50	0194400000
QL 4 SAK6N	57	50	0194500000
QL 10 SAK6N	57	20	0338300000
VH 12/4.9/3.3 SAK6N		100	0249000000
BS 25 O.IH SAKT1		50	0334700000
Width [mm]			
AP SAKT2 KRG	3	20	0329120000
TW SAKT2	2.5	20	0351820000
TSCH 2	0.6	100	0353660000
QVS 2 SAKT1+2		20	0307300000
QVS 3 SAKT1+2		20	0329300000
QVS 4 SAKT1+2		20	0307400000
VH 19/6/4.2 SAKT1		50	0318000000
BS 25 O.IH SAKT1		50	0334700000
PS 4 F.STB 4		20	0299600000
STB 14/D6/4/M3 SAK10		50	0169900000

SSP 3 SAKT1	100	0531760000
QS 2/8/4	20	0270960000

DEK 6,5

To safe the test sockets use the SD-blade or bits with pilots!

SAKT 4/35/LT

4 mm²

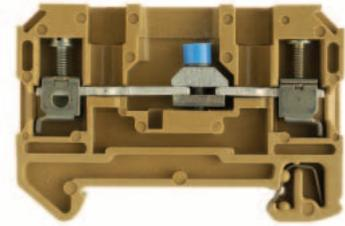

6 x 57.2 x 40
41 / 6
0.13 ... 6



IEC 60947-7-1

IEC	UL	CSA	EN 50019
400	300	300	
32	20	20	
4	AWG 22... 12	AWG 26... 10	
	6 / 3		
	A3 / 5VA		



Rated connection	Additional connection
0.5...6 / 1.5...4	
0.5...4 / 0.5...4	
0.4...0.7 (M 2.5)	
0.4...0.7	
10 / 3.5 x 0.6	

Tightening torque 1.6 Nm for 10 mm² stranded wire.

Type	Qty.	Order No.
SAKT 4/35/LT O.STB	50	1272420000
SAKT 4/35/LT STB2.0	50	1272520000

Type	Current [A]	Qty.	Order No.
QL 2 SAK2.5	41	100	0155900000
QL 3 SAK2.5	41	100	0156000000
QL 4 SAK2.5	41	50	0156100000
QL 10 SAK2.5	41	20	0338100000
VH 8/4.9/3.3 SAK2.5		100	0266700000
KISC M3X15/6 SAK2.5 CU5		100	0377200000
Width [mm]			
AP SAKT4 KRG	3	20	0244920000
TW AST1/PA HP/DBR/0.5	0.5	20	0474700000
TSCH 2	0.6	100	0353660000
QVS 2/4 SAKT4		20	1319260000
VH 16/5/3.5 SAK10-35		50	0309700000
BFSC M3X22 SAKT4		50	1319900000
PS 2.0 OR		20	0293800000
STB 8.5/D4.5/2/M3 SAKT4		50	0244600000
STB 8.5/5/2.3/M3 SAK2.5		50	0280600000

SSP 4 SAKT4	20	1319360000
-------------	----	------------

DEK 6,5

To safe the test sockets use the SD-blade or bits with pilots!

Feed-through terminals for thermocouples

Thermocouple-terminals
TS 35/PA

Busbars made from thermocouple materials according to DIN IEC 584

DK 4 Q/TC

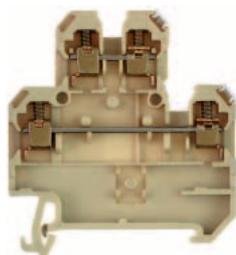

Width/length/height with TS35x7.5	mm
max. current / max. conductor	A/mm ²
max. clamping range	mm ²

6 x 54 x 60.5
/ 4
0.5 ... 4

Technical data

Measure/Approvals	
Width/length/height (mm)	with TS 35 x 7.5
Insulation stripping length/clamping screw/screwdriver blade	9 mm/M 3/3.5 x 0.6

Technical data/VDE	
Insulation stripping length/clamping screw/screwdriver blade	mm ²
	4

Tightening torque range	Nm
	0.5...1

Ordering data

Version	Type
NiCr	
Ni	
CuNi	
Fe	
Cu	
NiCr/Ni	K
Cu/CuNi	T
Fe/CuNi	J

Qty.	Order No.
100	1284160000
100	1285660000
100	1284060000

End plate	Type
	PA

Type	Width [mm]	Qty.	Order No.
AP (1.5)	1.5	20	1397160000

Partition	Type
	WEM
	for TS 32 HP

Type	Width [mm]	Qty.	Order No.
WTW EN	3.0	20	1058800000
TW HP	2.0	20	0607000000

Labelling systems	Labelling tags
	DEK 6

Weidmüller's **thermocouple-terminals** are specially designed for transmitting the smallest voltages in temperature measuring circuits. Special busbars ensure that no false signals occur in the terminal when temperature differences exist in the positive and negative path. This high measuring precision is necessary for, e.g. test beds, air craft engines, for complicated chemical processes, controls, etc.

I. Configuration of a temperature measuring circuit

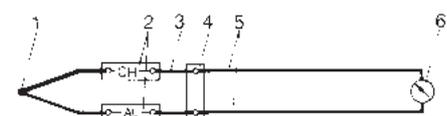

- 1 Thermocouple (sensor)
- 2 Thermocouple terminals
- 3 Compensation conductor
- 4 Reference point
- 5 Supply conductors (to and from)
- 6 Measuring device

The thermocouple terminals displayed in this measurement circuit are used to thermoelectrically transmit thermal e.m.f. of the thermocouple to the reference point and indicating device via the thermocouple.

II. Symbols Thermocouples according to IEC 584 DIN 43710

Terminal	Busbar material trade name
a) Type J	
Fe (positive leg)	Iron
CuNi (negative leg)	Constantan
b) Type T	
Cu (positive leg)	Copper
CuNi (negative leg)	Constantan
c) Type K	
NiCr (positive leg)	Chromel
Ni (negative leg)	Alumel

Detailed information on other accessories and their use can be found in the "Accessories" section.

Further versions on request.

Modular terminals with screwless connection

A

With tab connection TS 35 / PA

When using ATEX certified components in hazardous area applications the installation instructions and the rated data for accessories in the technical appendix must be considered.

Width/Length/Height with TS35x7.5	mm
Max. current / max. cond. cross-section	A/mm ²
Max. clamping range	mm ²

Technical data

Rated data	
Rated voltage	V
Rated current	A
Rated cross-section	mm ²
Rated impulse voltage / Pollution severity	kV/-
Plug gauge IEC 60-947-1 / flammability class acc. UL 94	
Approvals	

Clampable conductors (H05V/H07V)

Solid / stranded	mm ²
Flexible / flexible w. wire end ferrule	mm ²
Tightening torque range (clamping screw)	Nm
Stripping length / blade size	mm / -

2 clampable conductors of equal cross-section

Solid / stranded	mm ²
Flexible / flexible w. wire end ferrule	mm ²

Information

Order data

Version	
slotted	
Unslotted	
slotted blue	
Unslotted blue	

Information

Accessories

Cross-connection

	2-pole
	3-pole
	4-pole
(Q)	10-pole

Plug adapter

	2-pole
	3-pole
	4-pole
	5-polig
	8-pole

End plate / partition

End plate	
Partition	
Partition disc	

Testing/Checking

for testing	PS
wired terminal strips	StB

Insulating sleeve

	2,8
	6,3

Marking systems

DEK 6

For detailed information on other accessories and applications see "Accessories"

AST 1 / 35

2.5 mm²



6.5 x 58 x 46
20 / 4
0.2 ... 4

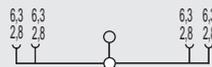

IEC 60947-7-1 / IEC 61210

IEC	UL	CSA	EN 50019
800	600	300	
20	13	16	
2.5			
	6 / 3		
	/ V2		



Rated connection

Additional connection

For tab connection use a insulated sleeve.

Type	Qty.	Order No.
AST 1/35 6.3/2.8	50	0699660000
AST 1/35 6.3	50	0664860000

Type	Current [A]	Qty.	Order No.
Q 2 SAK4	41	50	0336700000
Q 3 SAK4	41	50	0336800000
Q 4 SAK4	41	50	0336900000
Q 10 SAK4	41	20	0368800000

Width [mm]			
AP AST1+5 DB	1.5	20	0266400000
TW SAKS2 HP/DBR/2	2	20	0607000000
TSCH 1	2	100	0319160000

PS 2,3 RT	20	0180400000
STB 14/D5/2.3/M3 SAK2.5	50	0168600000

IH 2.8 DB	100	0386060000
IH 6.3 WEM GE	100	0386260000

DEK 6

AST 3/35

2.5 mm²



6.5 x 44 x 40.1
20

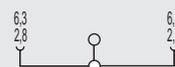

IEC 60947-7-1 / IEC 61210

IEC	UL	CSA	EN 50019
800	300	300	
20	13	16	
2.5			
	6 / 3		
	/ V2		



Rated connection

Additional connection

For tab connection use a insulated sleeve.

Type	Qty.	Order No.
AST 3/35 6.3/2.8	100	0460360000
AST 3/35 6.3	100	0479360000

Type	Current [A]	Qty.	Order No.
Q 2 SAK4	41	50	0336700000
Q 3 SAK4	41	50	0336800000
Q 4 SAK4	41	50	0336900000
Q 10 SAK4	41	20	0368800000

STA 2,5/2	100	0165860000
STA 2,5/3	50	0165960000
STA 2,5/4	50	0190360000
STA 2,5/5	50	0166060000
STA 2,5/8	50	0166160000

Width [mm]			
AP AST3+4 KRG	3	20	0298120000
TW 4 SAK4-10	1.5	20	0130160000
TSCH 1	2	100	0319160000

PS 2,3 RT	20	0180400000
STB 14/D5/2.3/M3 SAK2.5	50	0168600000

IH 2.8 DB	100	0386060000
IH 6.3 WEM GE	100	0386260000

DEK 6

Pluggable adapter STA 2,5/2 - STA 2,5/8 only for PA - Version.

Modular terminals with screwless connection

AST 4/35

2.5 mm²

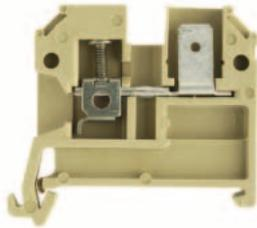

6.2 x 43.5 x 40.1
20 / 4
0.2 ... 4

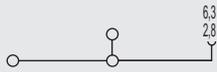

IEC 60947-7-1 / IEC 61210

IEC	UL	CSA	EN 50019
800	300	300	
20	13	16	
2.5	AWG 22... 12	AWG 24... 12	
	6 / 3		
	A3 / V2		



Rated connection	Additional connection
0.5...4 / 1.5...2.5	
0.5...2.5 / 0.5...2.5	
0.4...0.7 (M 2.5)	
9 / 3.5 x 0.6	

For tab connection use a insulated sleeve.

Type	Qty.	Order No.
AST 4/35 SF 6.3/2.8	100	0460460000
AST 4/35 SF 6.3	100	0479460000

Type	Current [A]	Qty.	Order No.
Q 2 SAK4	41	50	0336700000
Q 3 SAK4	41	50	0336800000
Q 4 SAK4	41	50	0336900000
Q 10 SAK4	41	20	0368800000
STA 2.5/2		100	0165860000
STA 2.5/3		50	0165960000
STA 2.5/4		50	0190360000
STA 2.5/5		50	0166060000
STA 2.5/8		50	0166160000
Width [mm]			
AP SAK2.5/35 + AST3+4	1.5	20	0460560000
TW 4 SAK4-10	1.5	20	0130160000
TSCH 1	2	100	0319160000
PS 2.3 RT		20	0180400000
STB 14/D5/2.3/M3 SAK2.5		50	0168600000
IH 2.8 DB		100	0386060000
IH 6.3 WEM GE		100	0386260000

DEK 6

Pluggable adapter STA 2,5/2 - STA 2,5/8 only for PA - Version.

AST 5/35

4 mm²

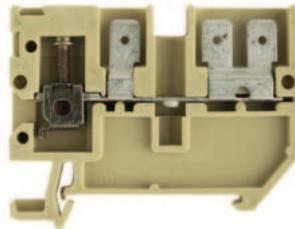

6.5 x 58 x 46
20 / 6
0.2 ... 6

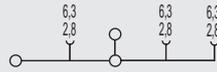

IEC 60947-7-1 / IEC 61210

IEC	UL	CSA	EN 50019
800	300	300	
20	13	16	
4	AWG 22... 12	AWG 24... 12	
	6 / 3		
	A4 / V2		



Rated connection	Additional connection
0.5...6 / 1.5...2.5	
0.5...4 / 0.5...4	
0.5...1.0 (M 3)	
12 / 3.5 x 0.6	

For tab connection use a insulated sleeve.

Type	Qty.	Order No.
AST 5/35 SF 6.3/2.8 DB	50	0664900000
AST 5/35 SF 6.3 DB	50	0699700000

Type	Current [A]	Qty.	Order No.
Q 2 SAK4	41	50	0336700000
Q 3 SAK4	41	50	0336800000
Q 4 SAK4	41	50	0336900000
Q 10 SAK4	41	20	0368800000
Width [mm]			
AP AST1+5 DB	1.5	20	0266400000
TW AST1/PA HP/DBR/0.5	0.5	20	0474700000
PS 2.3 RT		20	0180400000
STB 14/D5/2.3/M3 SAK2.5		50	0168600000
IH 2.8 DB		100	0386060000
IH 6.3 WEM GE		100	0386260000

DEK 6,5

SAK 4 S/35

4 mm²

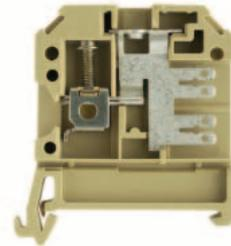

6.5 x 45 x 49.5
20 / 6
0.13 ... 6

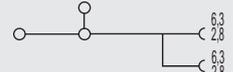

IEC 60947-7-1 / IEC 61210

IEC	UL	CSA	EN 50019
500	600	300	
20	13	13	
4	AWG 26... 12	AWG 26... 12	
	6 / 3		
	A4 / V2		



Rated connection	Additional connection
0.33...6 / 1.5...4	
0.5...4 / 0.5...4	
0.5...1.0 (M 3)	
12 / 3.5 x 0.6	

For tab connection use a insulated sleeve.

Type	Qty.	Order No.
SAK 4 S/35 6.3/2.8	100	0630360000

Type	Current [A]	Qty.	Order No.
QL 2 SAK4	32	100	0130600000
QL 3 SAK4	32	100	0130700000
QL 4 SAK4	32	50	0130800000
QL 10 SAK4	32	20	0338200000
Width [mm]			
AP SAK4-10	1.5	20	0117960000
TW 4 SAK4-10	1.5	20	0130160000
PS 2.3 RT		20	0180400000
STB 14/D5/2.3/M3 SAK2.5		50	0168600000
IH 2.8 DB		100	0386060000
IH 6.3 WEM GE		100	0386260000

DEK 6,5

Modular terminals with screwless connection

A

With tab connection TS 35 / PA

When using ATEX certified components in hazardous area applications the installation instructions and the rated data for accessories in the technical appendix must be considered.

Width/Length/Height with TS35x7.5	mm
Max. current / max. cond. cross-section	A/mm ²
Max. clamping range	mm ²

Technical data

Rated data	
Rated voltage	V
Rated current	A
Rated cross-section	mm ²
Rated impulse voltage / Pollution severity	kV/-
Plug gauge IEC 60-947-1 / flammability class acc. UL 94 Approvals	

Clampable conductors (H05V/H07V)	
Solid / stranded	mm ²
Flexible / flexible w. wire end ferrule	mm ²
Tightening torque range (clamping screw)	Nm
Stripping length / blade size	mm / -

2 clampable conductors of equal cross-section	
Solid / stranded	mm ²
Flexible / flexible w. wire end ferrule	mm ²

Information

Order data

Version	
slotted	
Unslotted	
slotted blue	
Unslotted blue	

Information

Accessories

Cross-connection	
	2-pole
	3-pole
	4-pole
	10-pole

Plug adapter	
	2-pole
	3-pole
	4-pole
	5-polig
	8-pole

End plate / partition	
	End plate
	Partition
	Partition disc

Testing/Checking	
for testing	PS
wired terminal strips	StB

Insulating sleeve	
	2,8
	6,3

Marking systems

For detailed information on other accessories and applications see "Accessories"

SAK 4 SS/35

4 mm²

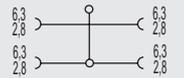

6.5 x 45 x 49.5	
20 / 4	
0.13 ... 4	

IEC 60947-7-1 / IEC 61210

IEC	UL	CSA	EN 50019
500	600	300	
20	13	13	
4	AWG 26... 12	AWG 26... 12	
6 / 3 / V2			



Rated connection	Additional connection

For tab connection use a insulated sleeve.

Type	Qty.	Order No.
SAK 4 SS/35 6.3/2.8	100	0630460000

Type	Current [A]	Qty.	Order No.
QL 2 SAK4	32	100	0130600000
QL 3 SAK4	32	100	0130700000
QL 4 SAK4	32	50	0130800000
QL 10 SAK4	32	20	0338200000

Width [mm]			
AP SAK4-10	1.5	20	0117960000
TW 4 SAK4-10	1.5	20	0130160000

IH 2.8 DB	100	0386060000
IH 6.3 WEM GE	100	0386260000

DEK 6,5

SAKR F

4 mm²



6.5 x 42 x 40.5	
10 / 4	
0.13 ... 4	

IEC 60947-7-1 / IEC 61210 / VDE 0100-537

IEC	UL	CSA	EN 50019
250	300	300	
10	10	10	
4	AWG 22... 12	AWG 22... 12	
6 / 3 A3 / V2			



Rated connection	Additional connection
0.5...4 / 1.5...4	
0.5...4 / 0.5...2.5	
0.5...1.0 (M3)	
8 / 3.5 x 0.6	

Type	Qty.	Order No.
SAKR F/35	100	6382670000

Type	Current [A]	Qty.	Order No.
QB 2 WI RA6 IS	27	50	0482700000
QB 3 WI RA6 IS	27	50	0482800000
QB 4 WI RA6 IS	27	50	0482900000

Width [mm]			
AP SAKR BE	1.5	20	0211360000

PS 2.3 RT	20	0180400000
STB 6/D3.7/2.3/M3 SAKR	100	0379400000

IH 2.8 DB	100	0386060000
-----------	-----	------------

DEK 6,5

QB 25 blank, see chapter accessories. To use twin ferrules ZH 0,5 to ZH 1,5 is possible.

Modular terminals with screwless connection

DK 4 SS/35

1 mm²

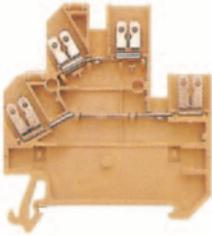

6 x 54 x 60.5
20 / 2.5
0.33 ... 2.5

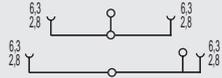

IEC 60947-7-1 / IEC 61210

IEC	UL	CSA	EN 50019
400	300	300	
20	10	10	
1	AWG 22... 12	AWG 22... 12	
	4 / 3		
	/ V2		



Rated connection **Additional connection**

For tab connection use a insulated sleeve.

DK 4 SS/35 2.8

1 mm²

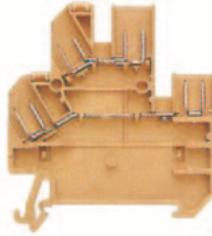

6 x 54 x 60.5
/ 2.5
0.33 ... 2.5



IEC 60947-7-1 / IEC 61210

IEC	UL	CSA	EN 50019
400	300	300	
20	10	10	
1	AWG 22... 12	AWG 22... 12	
	4 / 3		
	/ V2		



Rated connection **Additional connection**

For tab connection use a insulated sleeve.

DK 4 S

4 mm²

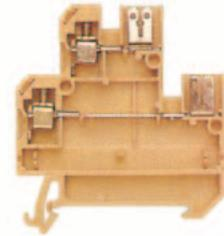

6 x 54 x 59.5
/ 4
0.33 ... 4

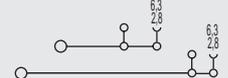

IEC 60947-7-1 / IEC 61210

IEC	UL	CSA	EN 50019
400	300	300	
10	10	10	
4	AWG 22... 12	AWG 22... 12	
	6 / 3		
	A3 / V2		



Rated connection **Additional connection**

0.5...4 / 1.5...4
0.5...4 / 0.5...2.5
0.5...0.8 (M3)
8 / 3.5 x 0.6

For tab connection use a insulated sleeve.

Type	Qty.	Order No.
DK 4SS/35 FF 4X6.3/2.8	100	0217160000

Type	Qty.	Order No.
DK 4SS/35 FF 8X2.8	100	0297060000

Type	Qty.	Order No.
DK 4S/35 SF 6.3/2.8	100	0686660000

Type	Current [A]	Qty.	Order No.
Q 2 AKZ4	32	50	0336400000
Q 3 AKZ4	32	50	0336500000
Q 4 AKZ4	32	50	0336600000
Q 10 AKZ4	32	20	0368600000

Type	Current [A]	Qty.	Order No.
Q 2 AKZ4	32	50	0336400000
Q 3 AKZ4	32	50	0336500000
Q 4 AKZ4	32	50	0336600000
Q 10 AKZ4	32	20	0368600000

Type	Current [A]	Qty.	Order No.
Q 2 AKZ4	32	50	0336400000
Q 3 AKZ4	32	50	0336500000
Q 4 AKZ4	32	50	0336600000
Q 10 AKZ4	32	20	0368600000

Width [mm]			
AP DK4S	20		0631360000
TSCH 6 DKI S4	5	100	0190260000
PS 2.3 RT	20		0180400000
STB 8.5/D4/2.3/M2.5 AKZ	50		0215700000
IH 2.8 DB	100		0386060000
IH 6.3 WEM GE	100		0386260000

Width [mm]			
AP DK4S	20		0631360000
TSCH 6 DKI S4	5	100	0190260000
PS 2.3 RT	20		0180400000
STB 8.5/D4/2.3/M2.5 AKZ	50		0215700000
IH 2.8 DB	100		0386060000

Width [mm]			
AP DK4S	20		0631360000
TSCH 6 DKI S4	5	100	0190260000
PS 2.3 RT	20		0180400000
STB 8.5/D4/2.3/M2.5 AKZ	50		0215700000
IH 2.8 DB	100		0386060000
IH 6.3 WEM GE	100		0386260000

DEK 6

DEK 6

DEK 6

Modular terminals with screwless connection

With tab connection
TS 35 / PA

DK 4 S 2.8

4 mm²

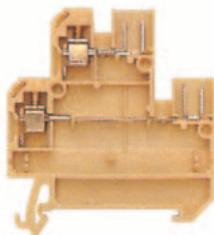

When using ATEX certified components in hazardous area applications the installation instructions and the rated data for accessories in the technical appendix must be considered.

Width/Length/Height with TS35x7.5	mm
Max. current / max. cond. cross-section	A/mm ²
Max. clamping range	mm ²

6 x 54 x 59.5

10 / 4

0.33 ... 4

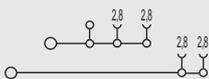

Technical data

Rated data

Rated voltage	V
Rated current	A
Rated cross-section	mm ²
Rated impulse voltage / Pollution severity	kV/-
Plug gauge IEC 60-947-1 / flammability class acc. UL 94	
Approvals	

IEC 60947-7-1 / IEC 61210

IEC	UL	CSA	EN 50019
400	300	300	
10	10	10	
4	AWG 22... 12	AWG 22... 12	
		6 / 3	
		A3 / V2	



Clampable conductors (H05V/H07V)

Solid / stranded	mm ²
Flexible / flexible w. wire end ferrule	mm ²
Tightening torque range (clamping screw)	Nm
Stripping length / blade size	mm / -

Rated connection

0.5...4 / 1.5...4

0.5...4 / 0.5...2.5

0.5...0.8 (M 3)

8 / 3.5 x 0.6

Additional connection

2 clampable conductors of equal cross-section

Solid / stranded	mm ²
Flexible / flexible w. wire end ferrule	mm ²

Information

For tab connection use a insulated sleeve.

Order data

Version

slotted
Unslotted
slotted blue
Unslotted blue

Information

Type

Type	Qty.	Order No.
DK 4S/35 SF 4X2.8	100	0686560000

Accessories

Cross-connection

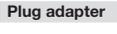
	2-pole
	3-pole
	4-pole
	10-pole

Plug adapter

2-pole
3-pole
4-pole
5-polig
8-pole

End plate / partition

End plate
Partition
Partition disc

Testing/Checking

for testing	PS
wired terminal strips	StB

Insulating sleeve

2,8
6,3

Type

Type	Current [A]	Qty.	Order No.
Q 2 AKZ4	32	50	0336400000
Q 3 AKZ4	32	50	0336500000
Q 4 AKZ4	32	50	0336600000
Q 10 AKZ4	32	20	0368600000

Width [mm]

Type	Width [mm]	Qty.	Order No.
AP DK4S	20		0631360000
TSCH 6 DKI S4	5	100	0190260000
PS 2,3 RT	20		0180400000
STB 8.5/D4/2.3/M2.5 AKZ	50		0215700000
IH 2.8 DB		100	0386060000

Marking systems

DEK 6

For detailed information on other accessories and applications see "Accessories"

Modular terminals with screwless connections

with solder connection
TS35 / PA

When using ATEX certified components in hazardous area applications the installation instructions and the rated data for accessories in the technical appendix must be considered.

Width/Length/Height with TS35x7.5	mm
Max. current / max. cond. cross-section	A/mm ²
Max. clamping range	mm ²

Technical data

Rated data	
Rated voltage	V
Rated current	A
Rated cross-section	mm ²
Rated impulse voltage / Pollution severity	kV/-
Plug gauge IEC 60-947-1 / flammability class acc. UL 94	
Approvals	
Clampable conductors (H05V/H07V)	
Solid / stranded	mm ²
Flexible / flexible w. wire end ferrule	mm ²
Tightening torque range (clamping screw)	Nm
Stripping length / blade size	mm / -
2 clampable conductors of equal cross-section	
Solid / stranded	mm ²
Flexible / flexible w. wire end ferrule	mm ²
Information	

Order data

Version	Information
beige	
blue	

Accessories

Cross-connection, screwable	
	(Q)
2-pole	
3-pole	
4-pole	
10-pole	
Connecting sleeve	
Fixing screw	
Fuse cartridges	
Cross-connection saddle	
Cross-connection saddle	
Connecting sleeve	
Fixing screw	
Socket / Test plug	
Socket	
Test plug	
End plate	
beige	
blue	
Partition / Partition disc	
beige	
blue	
Partition disc	
Cover / fixing screw (plastic)	
Cover	
Fixing screw (plastic)	
Marking systems	
DEK 6	
Detailed information on all versions in chapter accessories.	

SAK 2.5 L

2.5 mm²

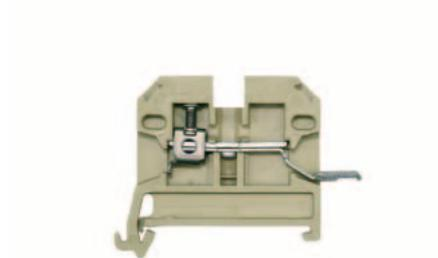

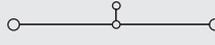
6 x 44 x 46.5	
17.5 / 6	
0.33 ... 6	

IEC 60947-7-1 / IEC 60068-2-20

IEC	UL	CSA	EN 50019
250		300	
17.5		10	
2.5		AWG 22...12	
		4 / 3	
		A3 / V2	



Rated connection	Additional connection
0.5...6 / 0.5...2.5	
0.5...4 / 0.5...2.5	
0.4...0.7 (M 2.5)	
12 / 3.5 x 0.6	

SAK 2.5 LL

1.5 mm²

solder connection both sides

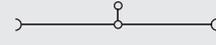

6 x 54 x 46.5	
17.5 / 3.3	
0.13 ... 3.3	

IEC 60947-7-1 / IEC 60068-2-20

IEC	UL	CSA	EN 50019
250		300	
17.5		10	
1.5		AWG 26...12	
		4 / 3	
		/ V2	



Rated connection	Additional connection

Type	Qty.	Order No.
SAK 2.5/35 LL	100	0567260000

Type	Current [A]	Qty.	Order No.
Q 2 SAK2.5	41	50	0337000000
Q 3 SAK2.5	41	50	0337100000
Q 4 SAK2.5	41	50	0337200000
Q 10 SAK2.5	41	20	0368700000
Width [mm]			
AP SAK2.5	1.5	20	0279560000
AP SAK2.5 BL	1.5	20	0279580000
Width [mm]			
TW SAK2.5	2.5	20	0302860000
TW SAK2.5 HP/TF/GE/1	1	20	0297100000
TSCH 1	2	100	0319160000
Width [mm]			
AD 4 AKZ4	50		0303400000
BFSC M3X22 PA/RT	100		0128900000
Width [mm]			
DEK 6			

Special terminal - SAKG

TS 35 / KRG

SAKG 32 I

50 mm²

TS 35 / KRG

A

When using ATEX certified components in hazardous area applications the installation instructions and the rated data for accessories in the technical appendix must be considered.

Width/Length/Height with TS35x7.5	mm
Max. current / max. cond. cross-section	A/mm ²
Max. clamping range	mm ²

32 x 87 x 84.5
192 / 70
10 ... 70



Technical data

Rated data	
Rated voltage	V
Rated current	A
Rated cross-section	mm ²
Rated impulse voltage / Pollution severity	kV/-
Plug gauge IEC 60-947-1 / flammability class acc. UL 94	
Approvals	

IEC 60947-7-1

IEC	UL	CSA	EN 50019
1000	600	600	
150	165	170	
50	AWG 6...3/0	AWG 1...2/0	
			8 / 3
B11 / 5VA			



Clampable conductors (H05V/H07V)	
Solid / stranded	mm ²
Flexible / flexible w. wire end ferrule	mm ²
Tightening torque range (clamping screw)	Nm
Stripping length / blade size	mm / -

Rated connection	Additional connection
10...16 / 10...70	
10...70 / 10...35	
6.0...12 (M 8)	
26	

2 clampable conductors of equal cross-section	
Solid / stranded	mm ²
Flexible / flexible w. wire end ferrule	mm ²

Information

Order data

Version
yellow
blue

Type	Qty.	Order No.
SAKG 32/35 I	10	0637120000

Information

Accessories

Cross-connection, screwable	
	2-pole
	3-pole
	4-pole
	10-pole
	Connecting sleeve
	Fixing screw
	Fuse cartridges

Type	Current [A]	Qty.	Order No.
QL 2 SAKG32+70	150	5	0194000000
QL 3 SAKG32+70	150	5	0441500000
QL 4 SAKG32+70	150	5	0441600000

Cross-connection saddle	
	Cross-connection saddle
	Connecting sleeve
	Fixing screw

Socket / Test plug	
	Socket
	Test plug

End plate	
	dark brown
	for tropical applications

Width [mm]			
EP 2 SAKG46/35 HP/DBR	2	10	0180700000
EP 2 SAKG46/35 HP/TF/GE	2	10	0180800000

Partition / Partition disc	
	dark brown
	for tropical applications
	Partition disc

Width [mm]			
TW SAKG46 HP/DBR/2	2	10	0177100000
TW SAKG46 HP/TF/GE/2	2	10	0179900000

Cover / fixing screw (plastic)	
	Cover
	Fixing screw (plastic)

AH 32 SAKG32	5	0326760000
--------------	---	------------

Marking systems

DEK 5

Detailed information on all versions in chapter accessories.

Special terminal - SAKG

TS 35 / KRG

SAKG 32 II

50 mm²

SAKG 32 II G

50 mm²

When using ATEX certified components in hazardous area applications the installation instructions and the rated data for accessories in the technical appendix must be considered.

Width/Length/Height with TS35x7.5	mm
Max. current / max. cond. cross-section	A/mm ²
Max. clamping range	mm ²

32 x 80 x 53	
192 / 70	
10 ... 70	

32 x 80 x 53	
192 / 70	
10 ... 70	

Technical data

Rated data	
Rated voltage	V
Rated current	A
Rated cross-section	mm ²
Rated impulse voltage / Pollution severity	kV/-
Plug gauge IEC 60-947-1 / flammability class acc. UL 94	
Approvals	

IEC 60947-7-1

IEC	UL	CSA	EN 50019
1000	600	600	
150	200	170	
50	AWG 6...3/0	AWG 1...2/0	
		8 / 3	
		/ 5VA	

IEC 60947-7-1

IEC	UL	CSA	EN 50019
1000	600	600	
150	200	170	
50	AWG 6...3/0	AWG 1...2/0	
		8 / 3	
		/ 5VA	

Clampable conductors (H05V/H07V)	
Solid / stranded	mm ²
Flexible / flexible w. wire end ferrule	mm ²
Tightening torque range (clamping screw)	Nm
Stripping length / blade size	mm / -

Rated connection		Additional connection	
6.0...12 (M 8)			

Rated connection		Additional connection	
6.0...12 (M 8)			

2 clampable conductors of equal cross-section	
Solid / stranded	mm ²
Flexible / flexible w. wire end ferrule	mm ²

Information

Order data

Version	
	yellow
	blue

Type	Qty.	Order No.
SAKG 32/35 II	10	0637320000

Type	Qty.	Order No.
SAKG 32/35 II/GW	10	0637420000

Information

Accessories

Cross-connection, screwable	
	2-pole
	3-pole
	4-pole
	10-pole
	Connecting sleeve
	Fixing screw
	Fuse cartridges

Type	Current [A]	Qty.	Order No.
QL 2 SAKG32+70	150	5	0194000000
QL 3 SAKG32+70	150	5	0441500000
QL 4 SAKG32+70	150	5	0441600000

Type	Current [A]	Qty.	Order No.
QL 2 SAKG32+70	150	5	0194000000
QL 3 SAKG32+70	150	5	0441500000
QL 4 SAKG32+70	150	5	0441600000

Cross-connection saddle	
	Cross-connection saddle
	Connecting sleeve
	Fixing screw

Socket / Test plug	
	Socket
	Test plug

End plate	
	dark brown
	for tropical applications

Width [mm]	
EP 2 SAKG46/35 HP/DBR	2 10 0180700000
EP 2 SAKG46/35 HP/TF/GE	2 10 0180800000

Width [mm]	
EP 1 SAKG32/35 HP/DBR	2 10 0180500000
EP 1 SAKG32/35 HP/TF/GE	2 10 0180600000

Partition / Partition disc	
	dark brown
	for tropical applications
	Partition disc

Width [mm]	
TW SAKG46 HP/DBR/2	2 10 0177100000
TW SAKG46 HP/TF/GE/2	2 10 0179900000

Width [mm]	
TW SAKG28 HP/DBR/2	2 10 0151400000
TW SAKG28 HP/TF/GE/2	2 10 0164600000

Cover / fixing screw (plastic)	
	Cover
	Fixing screw (plastic)

AH 32 SAKG32	5	0326760000
--------------	---	------------

AH 32 SAKG32	5	0326760000
--------------	---	------------

Marking systems

DEK 5		
-------	--	--

DEK 5		
-------	--	--

Detailed information on all versions in chapter accessories.

Special terminal - SAKG

TS 35 / KRG

SAKG 32 III

50 mm²

SAKG 70 II G

70 mm²



When using ATEX certified components in hazardous area applications the installation instructions and the rated data for accessories in the technical appendix must be considered.

Width/Length/Height with TS35x7.5	mm
Max. current / max. cond. cross-section	A/mm ²
Max. clamping range	mm ²

32 x 94 x 84.5	
192 / 70	
10 ... 70	

32 x 84 x 51.4	
192 / 95	
16 ... 95	

Technical data

Rated data	
Rated voltage	V
Rated current	A
Rated cross-section	mm ²
Rated impulse voltage / Pollution severity	kV/-
Plug gauge IEC 60-947-1 / flammability class acc. UL 94	
Approvals	

IEC 60947-7-1			
IEC	UL	CSA	EN 50019
1000	600	600	
150	165	185	
50	AWG 6...3/0	AWG 1...2/0	
	8 / 3		
	B11 / 5VA		

IEC 60947-7-1			
IEC	UL	CSA	EN 50019
1000		600	
192		200	
70		AWG 2/0...4/0	
	8 / 3		
	/ 5VA		

Clampable conductors (H05V/H07V)	
Solid / stranded	mm ²
Flexible / flexible w. wire end ferrule	mm ²
Tightening torque range (clamping screw)	Nm
Stripping length / blade size	mm / -

Rated connection		Additional connection	
10...16 / 10...70			
10...70 / 10...35			
6.0...12 (M 8)			
26			

Rated connection		Additional connection	
10...16 / 10...95			
10...95			
6.0...12 (M 8)			

2 clampable conductors of equal cross-section	
Solid / stranded	mm ²
Flexible / flexible w. wire end ferrule	mm ²

Information

Order data

Version	
	yellow
	blue

Type	Qty.	Order No.
SAKG 32/35 III	10	0637220000

Type	Qty.	Order No.
SAKG 70/35 II/GW	10	0636620000

Information

Accessories

Cross-connection, screwable	
	2-pole
	3-pole
	4-pole
	10-pole
	Connecting sleeve
	Fixing screw
	Fuse cartridges

Type	Current [A]	Qty.	Order No.

Type	Current [A]	Qty.	Order No.
QL 2 SAKG32+70	150	5	0194000000
QL 3 SAKG32+70	150	5	0441500000
QL 4 SAKG32+70	150	5	0441600000

Cross-connection saddle	
	Cross-connection saddle
	Connecting sleeve
	Fixing screw

Socket / Test plug	
	Socket
	Test plug

End plate	
	dark brown
	for tropical applications

Width [mm]			
EP 2 SAKG46/35 HP/DBR	2	10	0180700000
EP 2 SAKG46/35 HP/TF/GE	2	10	0180800000

Width [mm]			
EP 1 SAKG32/35 HP/DBR	2	10	0180500000
EP 1 SAKG32/35 HP/TF/GE	2	10	0180600000

Partition / Partition disc	
	dark brown
	for tropical applications
	Partition disc

Width [mm]			
TW SAKG46 HP/DBR/2	2	10	0177100000
TW SAKG46 HP/TF/GE/2	2	10	0179900000

Width [mm]			
TW SAKG28 HP/DBR/2	2	10	0151400000
TW SAKG28 HP/TF/GE/2	2	10	0164600000

Cover / fixing screw (plastic)	
	Cover
	Fixing screw (plastic)

AH 32 SAKG32	5	0326760000
--------------	---	------------

AH 32 SAKG32	5	0326760000
--------------	---	------------

Marking systems

DEK 5

DEK 5

Detailed information on all versions in chapter accessories.

Special terminal - SAKG

SAKG 40 I

95 mm²



40 x 94 x 84.5
232 / 95
10 ... 95

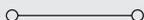

IEC 60947-7-1

IEC	UL	CSA	EN 50019
1000	600	600	
232	195	250	
95	...4/0	AWG 2/0...4/0	
8 / 3			
B12 / 5VA			



Rated connection	Additional connection
10...16 / 10...95	
10...95 / 10...35	
10...20 (M 10)	
25	

Type	Qty.	Order No.
SAKG 40/35 I	5	0637520000

Type	Current [A]	Qty.	Order No.
QL 2 SAKG40/35	232	5	0211400000
QL 3 SAKG40/35	232	5	0444900000
QL 4 SAKG40/35	232	5	0445000000

Width [mm]			
EP 2 SAKG46/35 HP/DBR	2	10	0180700000
EP 2 SAKG46/35 HP/TF/GE	2	10	0180800000

Width [mm]			
TW SAKG46 HP/DBR/2	2	10	0177100000
TW SAKG46 HP/TF/GE/2	2	10	0179900000

AH 40 SAKG40	5	0326860000
--------------	---	------------

DEK 5

SAKG 40 II

95 mm²



40 x 90 x 53
232 / 95
10 ... 95



IEC 60947-7-1

IEC	UL	CSA	EN 50019
1000	600	600	
232	230	250	
95	...4/0	AWG 2/0...4/0	
8 / 3			
/ 5VA			



Rated connection	Additional connection
...16 / 10...95	
10...95	
10...20 (M 10)	

Type	Qty.	Order No.
SAKG 40/35 II	5	0637720000

Type	Current [A]	Qty.	Order No.
QL 2 SAKG40/35	232	5	0211400000
QL 3 SAKG40/35	232	5	0444900000
QL 4 SAKG40/35	232	5	0445000000

Width [mm]			
EP 2 SAKG46/35 HP/DBR	2	10	0180700000
EP 2 SAKG46/35 HP/TF/GE	2	10	0180800000

Width [mm]			
TW SAKG46 HP/DBR/2	2	10	0177100000
TW SAKG46 HP/TF/GE/2	2	10	0179900000

AH 40 SAKG40	5	0326860000
--------------	---	------------

DEK 5

SAKG 40 II GW

95 mm²



40 x 90 x 53
232 / 95
10 ... 95

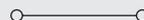

IEC 60947-7-1

IEC	UL	CSA	EN 50019
1000	600	600	
232	230	250	
95	...4/0	AWG 2/0...4/0	
8 / 3			
/ 5VA			



Rated connection	Additional connection
...16 / 10...95	
10...95	
10...20 (M 10)	

Type	Qty.	Order No.
SAKG 40/35 II/GW	5	0637820000

Type	Current [A]	Qty.	Order No.
QL 2 SAKG40/35	232	5	0211400000
QL 3 SAKG40/35	232	5	0444900000
QL 4 SAKG40/35	232	5	0445000000

Width [mm]			
EP 2 SAKG46/35 HP/DBR	2	10	0180700000
EP 2 SAKG46/35 HP/TF/GE	2	10	0180800000

Width [mm]			
TW SAKG46 HP/DBR/2	2	10	0177100000
TW SAKG46 HP/TF/GE/2	2	10	0179900000

AH 40 SAKG40	5	0326860000
--------------	---	------------

DEK 5

Special terminal - SAKG

TS 35 / KRG

SAKG 40 III

95 mm²

SAKG 46 II

150 mm²

TS 35 / KRG

A

When using ATEX certified components in hazardous area applications the installation instructions and the rated data for accessories in the technical appendix must be considered.

Width/Length/Height with TS35x7.5	mm
Max. current / max. cond. cross-section	A/mm ²
Max. clamping range	mm ²

40 x 98 x 84.5	
232 / 95	
10 ... 95	

46 x 106 x 57	
309 / 150	
16 ... 150	

Technical data

Rated data	
Rated voltage	V
Rated current	A
Rated cross-section	mm ²
Rated impulse voltage / Pollution severity	kV/-
Plug gauge IEC 60-947-1 / flammability class acc. UL 94 Approvals	

IEC 60947-7-1

IEC	UL	CSA	EN 50019
1000	600	600	
232	195	230	
95	...4/0	AWG 2/0...4/0	
8 / 3			
B12 / 5VA			

IEC 60947-7-1

IEC	UL	CSA	EN 50019
1000	600	600	
309	285	365	
150	AWG 4/0...300	kcmil 300	
8 / 3			
/ 5VA			

Clampable conductors (H05V/H07V)	
Solid / stranded	mm ²
Flexible / flexible w. wire end ferrule	mm ²
Tightening torque range (clamping screw)	Nm
Stripping length / blade size	mm / -

Rated connection	Additional connection
10...16 / 10...95	
10...95 / 10...95	
10...20 (M 10)	
25	

Rated connection	Additional connection
10...16 / 10...150	
10...150	
14...31 (M 12)	

2 clampable conductors of equal cross-section	
Solid / stranded	mm ²
Flexible / flexible w. wire end ferrule	mm ²

Information

Order data

Version	
yellow	
blue	

Type	Qty.	Order No.
SAKG 40/35 III	5	0637620000

Type	Qty.	Order No.
SAKG 46/35 II	5	0637920000

Information

Accessories

Cross-connection, screwable	
	2-pole
	3-pole
	4-pole
	10-pole
	Connecting sleeve
	Fixing screw
	Fuse cartridges

Type	Current [A]	Qty.	Order No.

Type	Current [A]	Qty.	Order No.
QL 2 SAKG46	309	5	0247000000
QL 3 SAKG46	309	5	0444400000
QL 4 SAKG46	309	5	0444500000

Cross-connection saddle	
	Cross-connection saddle
	Connecting sleeve
	Fixing screw

Socket / Test plug	
	Socket
	Test plug

End plate	
	dark brown
	for tropical applications

Width [mm]			
EP 2 SAKG46/35 HP/DBR	2	10	0180700000
EP 2 SAKG46/35 HP/TF/GE	2	10	0180800000

Width [mm]			
EP 2 SAKG46/35 HP/DBR	2	10	0180700000
EP 2 SAKG46/35 HP/TF/GE	2	10	0180800000

Partition / Partition disc	
	dark brown
	for tropical applications
	Partition disc

Width [mm]			
TW SAKG46 HP/DBR/2	2	10	0177100000
TW SAKG46 HP/TF/GE/2	2	10	0179900000

Width [mm]			
TW SAKG46 HP/DBR/2	2	10	0177100000
TW SAKG46 HP/TF/GE/2	2	10	0179900000

Cover / fixing screw (plastic)	
	Cover
	Fixing screw (plastic)

AH 40 SAKG40	5	0326860000
--------------	---	------------

AH 46 SAKG46	5	0326960000
--------------	---	------------

Marking systems

DEK 5

DEK 5

Detailed information on all versions in chapter accessories.

Special terminal - SAKG

SAKG 46 II GW

150 mm²



46 x 106 x 57
309 / 150
16 ... 150



IEC 60947-7-1

IEC	UL	CSA	EN 50019
1000	600	600	
309	285	365	
150	AWG 4/0...300	kcmil 300	
	8 / 3		
	/ 5VA		



Rated connection	Additional connection
10...16 / 10...150	
10...150	
14...31 (M 12)	

SAKG 54 II

240 mm²



54 x 122 x 60,5
415 / 240
70 ... 240



IEC 60947-7-1

IEC	UL	CSA	EN 50019
1000	600	600	
415	380	600	
240	...500	kcmil 300...500	
	8 / 3		
	/ 5VA		



Rated connection	Additional connection
25...60 (M 16)	

SAKG 54 II GW

240 mm²

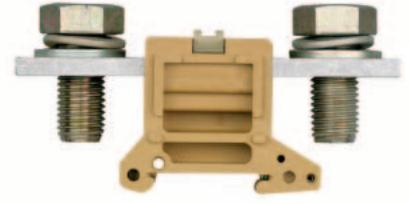

54 x 122 x 60,5
415 / 240
70 ... 240

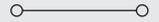

IEC 60947-7-1

IEC	UL	CSA	EN 50019
1000	600	600	
415	380	600	
240	...500	kcmil 300...500	
	8 / 3		
	/ 5VA		



Rated connection	Additional connection
25...60 (M 16)	

Type	Qty.	Order No.
SAKG 46/35 II/GW	5	0638020000

Type	Qty.	Order No.
SAKG 54/35 II	5	0638120000

Type	Qty.	Order No.
SAKG 54/35 II/GW	5	0638220000

Type	Current [A]	Qty.	Order No.
QL 2 SAKG46	309	5	0247000000
QL 3 SAKG46	309	5	0444400000
QL 4 SAKG46	309	5	0444500000

Type	Current [A]	Qty.	Order No.
QL 2 SAKG54	415	5	0264400000
QL 3 SAKG54	415	5	0408000000
QL 4 SAKG54	415	5	0247400000

Type	Current [A]	Qty.	Order No.
QL 2 SAKG54	415	5	0264400000
QL 3 SAKG54	415	5	0408000000
QL 4 SAKG54	415	5	0247400000

Width [mm]			
EP 2 SAKG46/35 HP/DBR	2	10	0180700000
EP 2 SAKG46/35 HP/TF/GE	2	10	0180800000

Width [mm]			
EP 2 SAKG46/35 HP/DBR	2	10	0180700000
EP 2 SAKG46/35 HP/TF/GE	2	10	0180800000

Width [mm]			
EP 2 SAKG46/35 HP/DBR	2	10	0180700000
EP 2 SAKG46/35 HP/TF/GE	2	10	0180800000

Width [mm]			
TW SAKG46 HP/DBR/2	2	10	0177100000
TW SAKG46 HP/TF/GE/2	2	10	0179900000

Width [mm]			
TW SAKG46 HP/DBR/2	2	10	0177100000
TW SAKG46 HP/TF/GE/2	2	10	0179900000

Width [mm]			
TW SAKG46 HP/DBR/2	2	10	0177100000
TW SAKG46 HP/TF/GE/2	2	10	0179900000

AH 46 SAKG46	5	0326960000
--------------	---	------------

DEK 5		
-------	--	--

DEK 5		
-------	--	--

DEK 5

DEK 5

DEK 5

Stud Terminal - KST

TS 35 / PA

KST 5/35

10 mm²

KST 6/35

16 mm²

TS 35 / PA

A

When using ATEX certified components in hazardous area applications the installation instructions and the rated data for accessories in the technical appendix must be considered.

Width/Length/Height with TS35x7.5	mm
Max. current / max. cond. cross-section	A/mm ²
Max. clamping range	mm ²

24 x 62.5 x 49.5
57 / 10

24 x 62.5 x 54,5
76 / 16



Technical data

Rated data w. partition, Wemid	
Rated voltage	V
Rated current	A
Rated cross-section	mm ²
Rated impulse voltage / Pollution severity	kV/-
Plug gauge IEC 60-947-1 / flammability class acc. UL 94	
Approvals	

IEC	UL	CSA	EN 50019
1000	600	600	
57	50	65	
10	AWG 12...6	AWG 8...2	
		8 / 3	
		/ V2	

IEC	UL	CSA	EN 50019
1000	600	600	
76	65	80	
16	AWG 12...6	AWG 12...6	
		8 / 3	
		/ V2	

Rated data w. partition, Epoxy resin	
Rated voltage / Rated impulse voltage	V/kV

EN 50124

EN 50124

Clamped cable lug	
DIN 46234 / 1 cable lug per side	mm ²
DIN 46234 / 2 cable lug per side	mm ²
DIN 46234 / 1 cable lug per side	mm ²
DIN 46234 / 2 cable lug per side	mm ²
Tightening torque range	Nm

2.0...4.0

3.0...6.0

Information

Order data

Version	
TS 35 x 7.5	
TS 35 x 15/2.3	

Type	Height	Qty.	Order No.
KST 5/35 M5X18	49,5	25	9508230000
KST 5/35 M5X18	49,5	25	9528300000

Type	Height	Qty.	Order No.
KST 6/35 M6X22	54,5	25	9506940000
KST 6/35 M6X22	62	25	9528310000

Information

Accessories

Cross-connection	
2-pole	
3-pole	

Type	Current [A]	Qty.	Order No.
QL 2 KST6		5	9501350000

Type	Current [A]	Qty.	Order No.
QL 2 KST6		5	9501350000

Partition		right	left
	TW KST5-12 RE/NO 160/HM	10	1718530000
	TW KST5-12 LI/NO 160/HM	10	1752800000

W/L/H TS 35 [mm]			
	TW KST5-12 RE/NO 160/HM	10	1718530000
	TW KST5-12 LI/NO 160/HM	10	1752800000

W/L/H TS 35 [mm]			
	TW KST5-12 RE/NO 160/HM	10	1718530000
	TW KST5-12 LI/NO 160/HM	10	1752800000

Marking systems

DEK 5

DEK 5

For detailed information on other accessories and applications see "Accessories"

Stud Terminal - KST

KST 8/35

35 mm²

KST 10/35

70 mm²

KST 12/35

95 mm²



24 x 62.5 x 64,5
125 / 35



35 x 62.5 x 74,5
192 / 70



34 x 62.5 x 74,5
232 / 95



IEC	UL	CSA	EN 50019
1000	600	600	
125	115	130	
35	AWG 12... 2	AWG 12... 2	
	8 / 3		
	/ V2		



EN 50124

IEC	UL	CSA	EN 50019
1000	600	600	
192	175	200	
70	AWG 12... 2/0	AWG 12... 2/0	
	8 / 3		
	/ V2		



EN 50124

IEC	UL	CSA	EN 50019
1000	600	600	
232	200	250	
95	AWG 12... 3		
	8 / 3		
	/ V2		



EN 50124

6.0...12

10...20

14...31

Type	Height	Qty.	Order No.
KST 8/35 M8X30	64,5	25	9506950000
KST 8/35 M8X30	72	25	9528320000

Type	Height	Qty.	Order No.
KST 10/35 M10X39	74,5	20	9506960000
KST 10/35 M10X39	82	20	9528330000

Type	Height	Qty.	Order No.
KST 12/35 M12X37	78	20	9506970000
KST 12/35 M12X37	74,5	20	9528340000

Type	Current [A]	Qty.	Order No.
QL 2 KST8		5	9501360000

Type	Current [A]	Qty.	Order No.
QL 2 KST10		5	9501370000

Type	Current [A]	Qty.	Order No.
QL 2 KST12		5	9501380000

W/L/H TS 35 [mm]			
TW KST5-12 RE/NO 160/HM	10		1718530000
TW KST5-12 LI/NO 160/HM	10		1752800000

W/L/H TS 35 [mm]			
TW KST5-12 RE/NO 160/HM	10		1718530000
TW KST5-12 LI/NO 160/HM	10		1752800000

W/L/H TS 35 [mm]			
TW KST5-12 RE/NO 160/HM	10		1718530000
TW KST5-12 LI/NO 160/HM	10		1752800000

DEK 5

DEK 5

DEK 5

Modular terminals with electronic components

With electronic components TS 35 / PA

When using ATEX certified components in hazardous area applications the installation instructions and the rated data for accessories in the technical appendix must be considered.

Width/Length/Height with TS35x7.5	mm
Max. current / max. cond. cross-section	A/mm ²
Max. clamping range	mm ²

Technical data

Rated data	
Rated voltage	V
Rated current	A
Rated cross-section	mm ²
Rated impulse voltage / Pollution severity	kV/-
Plug gauge IEC 60-947-1 / flammability class acc. UL 94	
Approvals	

Electronic built-in components

Diode current / diode voltage	V / A
voltage LED / current LED / polarity	V / mA / -
Resistance / Varistor	-/V

Clampable conductors (H05V/H07V)

Solid / stranded	mm ²
Flexible / flexible w. wire end ferrule	mm ²
Tightening torque range (clamping screw)	Nm
Stripping length / blade size	mm / -

Information

Order data

Version	
Terminal components	LED red
see circuit diagram above	LED green
	Neon lamp
	Neon lamp

Information

Accessories

Cross-connection, screwable	
	2-pole
	3-pole
	4-pole
	10-pole

External cross-connection	
	2-pole
	3-pole
	4-pole

End plate	
	beige

Socket	

Test plug	

Connecting sleeve	

Cross-connection saddle	

Fixing screw / Partition disc	
Fixing screw	
Partition disc	

Marking systems	

For detailed information on other accessories and applications see "Accessories"

DK 4 LD/1

4 mm²

DC voltage indicator



6 x 50 x 52.5
10 / 4
0.33 ... 4

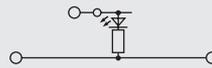

IEC 60947-7-1

IEC	UL	CSA	EN 50019
24			
10			
4			
	1 / 3		
	A3 / V2		



24 / 5

Rated connection	Additional connection
0.5...4 / 0.5...4	
0.5...4 / 0.5...4	
0.5...1.0 (M3)	
9 / 3.5 x 0.6	

DK 4 LD/2

4 mm²

DC voltage indicator

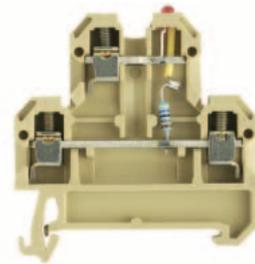

6 x 50 x 52.5
10 / 4
0.33 ... 4

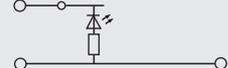

IEC 60947-7-1

IEC	UL	CSA	EN 50019
24			
10			
4			
	1 / 3		
	A3 / V2		



24 / 5

Rated connection	Additional connection
0.5...4 / 0.5...4	
0.5...4 / 0.5...4	
0.5...1.0 (M3)	
9 / 3.5 x 0.6	

Modular terminals with electronic components

DK 4 LD/3

4 mm²

DC voltage indicator

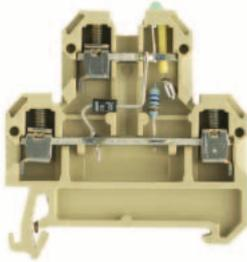

6 x 50 x 52.5
10 / 4
0.33 ... 4

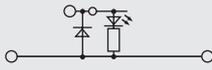

IEC 60947-7-1

IEC	UL	CSA	EN 50019
24			
10			
4			
	1 / 3		
	A3 / V2		
24 / 5			

Rated connection

Additional connection

0.5...4 / 0.5...4
0.5...4 / 0.5...4
0.5...1.0 (M3)
9 / 3.5 x 0.6

Type	Voltage	Qty.	Order No.
DK 4/35 LD ROT 24VDC	24 VDC	25	0210260000
DK 4/35 LD GR 24VDC	24 VDC	25	0210460000

Type	Current [A]	Qty.	Order No.
Q 2 AKZ4	32	50	0336400000
Q 3 AKZ4	32	50	0336500000
Q 4 AKZ4	32	50	0336600000

Current [A]			
QB 2 WI RA6 IS	27	50	0482700000
QB 3 WI RA6 IS	27	50	0482800000
QB 4 WI RA6 IS	27	50	0482900000

AP DK4 20 0359260000

STB 8.5/D4/2.3/M2.5 AKZ 50 0215700000

PS 2.3 RT 20 0180400000

VH 10/4/2.8 AKZ4 50 0446600000

VL 2 AKZ4/DK4 50 0446700000

BFSC M2.5X14 SAKD2.5N 100 0266800000

TSCH 4 AKZ4 100 0363360000

DEK 6

DK 4 LD/4

4 mm²

DC voltage indicator



6 x 50 x 52.5
10 / 4
0.33 ... 4

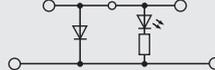

IEC 60947-7-1

IEC	UL	CSA	EN 50019
24			
10			
4			
	1 / 3		
	A3 / V2		
24 / 5			

Rated connection

Additional connection

0.5...4 / 0.5...4
0.5...4 / 0.5...4
0.5...1.0 (M3)
9 / 3.5 x 0.6

Type	Voltage	Qty.	Order No.
DK 4/35 LD ROT 24VDC	24 VDC	25	0209860000
DK 4/35 LD GR 24VDC	24 VDC	25	0210060000

Type	Current [A]	Qty.	Order No.
Q 2 AKZ4	32	50	0336400000
Q 3 AKZ4	32	50	0336500000
Q 4 AKZ4	32	50	0336600000

Current [A]			
QB 2 WI RA6 IS	27	50	0482700000
QB 3 WI RA6 IS	27	50	0482800000
QB 4 WI RA6 IS	27	50	0482900000

AP DK4 20 0359260000

STB 8.5/D4/2.3/M2.5 AKZ 50 0215700000

PS 2.3 RT 20 0180400000

VH 10/4/2.8 AKZ4 50 0446600000

VL 2 AKZ4/DK4 50 0446700000

BFSC M2.5X14 SAKD2.5N 100 0266800000

TSCH 4 AKZ4 100 0363360000

DEK 6

DK 4 LD/5

4 mm²

AC voltage indicator



6 x 50 x 52.5
10 / 4
0.33 ... 4

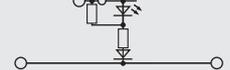

IEC 60947-7-1

IEC	UL	CSA	EN 50019
24			
10			
4			
	1 / 3		
	A3 / V2		
24 / 5			

Rated connection

Additional connection

0.5...4 / 0.5...4
0.5...4 / 0.5...4
0.5...1.0 (M3)
9 / 3.5 x 0.6

Type	Voltage	Qty.	Order No.
DK 4/35 LD 1D ROT 24VAC	24 VAC	25	0395960000
DK 4/35 LD 1D 48VAC	48 VAC	25	0396060000

Type	Current [A]	Qty.	Order No.
Q 2 AKZ4	32	50	0336400000
Q 3 AKZ4	32	50	0336500000
Q 4 AKZ4	32	50	0336600000

Current [A]			
QB 2 WI RA6 IS	27	50	0482700000
QB 3 WI RA6 IS	27	50	0482800000
QB 4 WI RA6 IS	27	50	0482900000

AP DK4 20 0359260000

STB 8.5/D4/2.3/M2.5 AKZ 50 0215700000

PS 2.3 RT 20 0180400000

VH 10/4/2.8 AKZ4 50 0446600000

VL 2 AKZ4/DK4 50 0446700000

BFSC M2.5X14 SAKD2.5N 100 0266800000

TSCH 4 AKZ4 100 0363360000

DEK 6

Modular terminals with electronic components

With electronic components TS 35 / PA

When using ATEX certified components in hazardous area applications the installation instructions and the rated data for accessories in the technical appendix must be considered.

Width/Length/Height with TS35x7.5	mm
Max. current / max. cond. cross-section	A/mm ²
Max. clamping range	mm ²

Technical data

Rated data	
Rated voltage	V
Rated current	A
Rated cross-section	mm ²
Rated impulse voltage / Pollution severity	kV/-
Plug gauge IEC 60-947-1 / flammability class acc. UL 94	
Approvals	
Electronic built-in components	
Diode current / diode voltage	V / A
voltage LED / current LED / polarity	V / mA / -
Resistance / Varistor	-/V
Clampable conductors (H05V/H07V)	
Solid / stranded	mm ²
Flexible / flexible w. wire end ferrule	mm ²
Tightening torque range (clamping screw)	Nm
Stripping length / blade size	mm / -
Information	

Order data

Version	
Terminal components	LED red
see circuit diagram above	LED green
	Neon lamp
	Neon lamp
Information	

Accessories

Cross-connection, screwable	
	2-pole
	3-pole
	4-pole
	10-pole
External cross-connection	
	2-pole
	3-pole
	4-pole
End plate	
	beige
Socket	
Test plug	
Connecting sleeve	
Cross-connection saddle	
Fixing screw / Partition disc	
	Fixing screw
	Partition disc
Marking systems	
For detailed information on other accessories and applications see "Accessories"	

DK 4 GL

4 mm²

AC voltage indicator

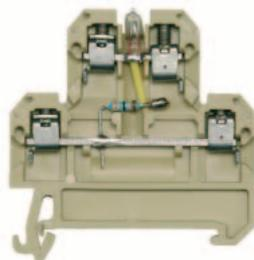

6 x 50 x 52.5
10 / 4
0.33 ... 4

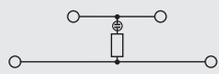

IEC 60947-7-1

IEC	UL	CSA	EN 50019
230			
10			
4			
	1 / 3		
	A3 / V2		
			
230 / 5			
Rated connection		Additional connection	
0.5...4 / 0.5...4			
0.5...4 / 0.5...4			
0.5...1.0 (M3)			
9 / 3.5 x 0.6			
Information			

Type	Voltage	Qty.	Order No.
DK 4/35 GL 330K 230VAC	230 VAC	25	0663160000
DK 4/35 GL 100K 115VAC	115 VAC	25	0396260000
Information			

Type	Current [A]	Qty.	Order No.
Q 2 AKZ4	32	50	0336400000
Q 3 AKZ4	32	50	0336500000
Q 4 AKZ4	32	50	0336600000
Current [A]			
QB 2 WI RA6 IS	27	50	0482700000
QB 3 WI RA6 IS	27	50	0482800000
QB 4 WI RA6 IS	27	50	0482900000
AP DK4		20	0359260000
STB 8.5/D4/2.3/M2.5 AKZ		50	0215700000
PS 2.3 RT		20	0180400000
VH 10/4/2.8 AKZ4		50	0446600000
VL 2 AKZ4/DK4		50	0446700000
BFSC M2.5X14 SAKD2.5N		100	0266800000
TSCH 4 AKZ4		100	0363360000
DEK 6			
Information			

DK 4 GL I

4 mm²

Current indicator

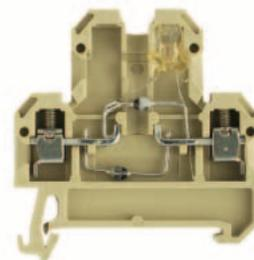

6 x 50 x 52.5
/ 4
0.33 ... 4



IEC	UL	CSA	EN 50019
250			
4			
	1 / 3		
	A3 / V2		
			
250 / 1			
Rated connection		Additional connection	
0.5...4 / 0.5...4			
0.5...4 / 0.5...4			
0.5...1.0 (M3)			
9 / 3.5 x 0.6			
Information			

Type	Voltage	Qty.	Order No.
DK 4/35 GL 1D 11,0A	250 VAC	25	1111160000
Information			

Type	Current [A]	Qty.	Order No.
Q 2 AKZ4	32	50	0336400000
Q 3 AKZ4	32	50	0336500000
Q 4 AKZ4	32	50	0336600000
Q 10 AKZ4	32	20	0368600000
Current [A]			
QB 2 WI RA6 IS	27	50	0482700000
QB 3 WI RA6 IS	27	50	0482800000
QB 4 WI RA6 IS	27	50	0482900000
AP DK4		20	0359260000
STB 8.5/D4/2.3/M2.5 AKZ		50	0215700000
PS 2.3 RT		20	0180400000
VH 10/4/2.8 AKZ4		50	0446600000
VL 2 AKZ4/DK4		50	0446700000
BFSC M2.5X14 SAKD2.5N		100	0266800000
TSCH 4 AKZ4		100	0363360000
DEK 6			
Information			

Modular terminals with electronic components

With electronic components TS 35 / PA

When using ATEX certified components in hazardous area applications the installation instructions and the rated data for accessories in the technical appendix must be considered.

Width/Length/Height with TS35x7.5	mm
Max. current / max. cond. cross-section	A/mm ²
Max. clamping range	mm ²

Technical data

Rated data	
Rated voltage	V
Rated current	A
Rated cross-section	mm ²
Rated impulse voltage / Pollution severity	kV/-
Plug gauge IEC 60-947-1 / flammability class acc. UL 94	
Approvals	

Electronic built-in components	
Diode current / diode voltage	V / A
voltage LED / current LED / polarity	V / mA / -
Resistance / Varistor	-/V

Clampable conductors (H05V/H07V)	
Solid / stranded	mm ²
Flexible / flexible w. wire end ferrule	mm ²
Tightening torque range (clamping screw)	Nm
Stripping length / blade size	mm / -

Information

Order data

Version	
Terminal components	LED red
see circuit diagram above	LED green
	Neon lamp
	Neon lamp

Information

Accessories

Cross-connection, screwable	
	2-pole
	3-pole
	4-pole
	10-pole

External cross-connection	
	2-pole
	3-pole
	4-pole

End plate	
	beige

Socket	

Test plug	

Connecting sleeve	

Cross-connection saddle	

Fixing screw / Partition disc	
Fixing screw	
Partition disc	

Marking systems	

For detailed information on other accessories and applications see "Accessories"

DK 4 D/1

4 mm²

Diode terminal, e.g. as protection against polarity reversal

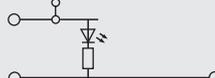

6 x 50 x 52.5	
10 / 4	
0.33 ... 4	

IEC	UL	CSA	EN 50019
380		380	
10	1		
4		AWG 22... 12	
		/ 3	
		A3 / V2	

Approvals	
1000 / 1	
	/ 1000

Rated connection	Additional connection
0.5...4 / 0.5...4	
0.5...4 / 0.5...4	
0.5...0.8 (M3)	
9 / 3.5 x 0.6	

Type	Voltage	Qty.	Order No.
DK 4/35 1D GET.SCH.	380 V	25	0396360000

Information

Type	Current [A]	Qty.	Order No.
Q 2 AKZ4	32	50	0336400000
Q 3 AKZ4	32	50	0336500000
Q 4 AKZ4	32	50	0336600000

Current [A]			
QB 2 WI RA6 IS	27	50	0482700000
QB 3 WI RA6 IS	27	50	0482800000
QB 4 WI RA6 IS	27	50	0482900000

AP DK4			
		20	0359260000

STB 8.5/D4/2.3/M2.5 AKZ			
		50	0215700000

PS 2.3 RT			
		20	0180400000

VH 10/4/2.8 AKZ4			
		50	0446600000

VL 2 AKZ4/DK4			
		50	0446700000

BFSC M2.5X14 SAKD2.5N			
		100	0266800000

TSCH 4 AKZ4			
		100	0363360000

DEK 6			

DK 4 D/2

4 mm²

suppressor circuit for relay and magnetic valve (DC)

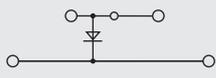

6 x 50 x 52.5	
10 / 4	
0.33 ... 4	

IEC	UL	CSA	EN 50019
380		380	
10	1		
4		AWG 22... 12	
		/ 3	
		A3 / V2	

Approvals	
1000 / 1	
	/ 1000

Rated connection	Additional connection
0.5...4 / 0.5...4	
0.5...4 / 0.5...4	
0.5...0.8 (M3)	
9 / 3.5 x 0.6	

Type	Voltage	Qty.	Order No.
DK 4/35 1D A1	380 V	25	0538960000
DK 4/35 1D A1	380 V	25	0538980000

Information

Type	Current [A]	Qty.	Order No.
Q 2 AKZ4	32	50	0336400000
Q 3 AKZ4	32	50	0336500000
Q 4 AKZ4	32	50	0336600000

Current [A]			
QB 2 WI RA6 IS	27	50	0482700000
QB 3 WI RA6 IS	27	50	0482800000
QB 4 WI RA6 IS	27	50	0482900000

AP DK4			
		20	0359260000

STB 8.5/D4/2.3/M2.5 AKZ			
		50	0215700000

PS 2.3 RT			
		20	0180400000

VH 10/4/2.8 AKZ4			
		50	0446600000

VL 2 AKZ4/DK4			
		50	0446700000

BFSC M2.5X14 SAKD2.5N			
		100	0266800000

TSCH 4 AKZ4			
		100	0363360000

DEK 6			

Modular terminals with electronic components

With electronic components TS 35 / PA

When using ATEX certified components in hazardous area applications the installation instructions and the rated data for accessories in the technical appendix must be considered.

Width/Length/Height with TS35x7.5	mm
Max. current / max. cond. cross-section	A/mm ²
Max. clamping range	mm ²

Technical data

Rated data	
Rated voltage	V
Rated current	A
Rated cross-section	mm ²
Rated impulse voltage / Pollution severity	kV/-
Plug gauge IEC 60-947-1 / flammability class acc. UL 94	
Approvals	

Electronic built-in components	
Diode current / diode voltage	V / A
voltage LED / current LED / polarity	V / mA / -
Resistance / Varistor	-/V

Clampable conductors (H05V/H07V)	
Solid / stranded	mm ²
Flexible / flexible w. wire end ferrule	mm ²
Tightening torque range (clamping screw)	Nm
Stripping length / blade size	mm / -

Information

Order data

Version	
Terminal components	LED red
see circuit diagram above	LED green
	Neon lamp
	Neon lamp

Information

Accessories

Cross-connection, screwable	
	2-pole
	3-pole
	4-pole
	10-pole

External cross-connection	
	2-pole
	3-pole
	4-pole

End plate	
	beige

Socket	

Test plug	

Connecting sleeve	

Cross-connection saddle	

Fixing screw / Partition disc	
Fixing screw	
Partition disc	

Marking systems	

For detailed information on other accessories and applications see "Accessories"

DK 4 D/3

4 mm²

suppressor circuit for relay and magnetic valve (DC)

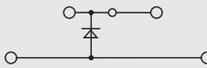

6 x 50 x 52.5	
10 / 4	
0.33 ... 4	

IEC	UL	CSA	EN 50019
380			
10			
4			
		/ 3	
		A3 / V2	

Rated connection		Additional connection	
1000 / 1			
	/ 1000		

Rated connection		Additional connection	
0.5...4 / 0.5...4			
0.5...4 / 0.5...4			
0.5...0.8 (M3)			
9 / 3.5 x 0.6			

Type	Voltage	Qty.	Order No.
DK 4/35 1D A2	380 V	25	0538860000
DK 4/35 1D A2	380 V	25	0538880000

Information

Type	Current [A]	Qty.	Order No.
Q 2 AKZ4	32	50	0336400000
Q 3 AKZ4	32	50	0336500000
Q 4 AKZ4	32	50	0336600000

Current [A]			
QB 2 WI RA6 IS	27	50	0482700000
QB 3 WI RA6 IS	27	50	0482800000
QB 4 WI RA6 IS	27	50	0482900000

AP DK4			
		20	0359260000

STB 8.5/D4/2.3/M2.5 AKZ			
		50	0215700000

PS 2.3 RT			
		20	0180400000

VH 10/4/2.8 AKZ4			
		50	0446600000

VL 2 AKZ4/DK4			
		50	0446700000

BFSC M2.5X14 SAKD2.5N			
		100	0266800000

TSCH 4 AKZ4			
		100	0363360000

DEK 6			

For detailed information on other accessories and applications see "Accessories"			

DK 4 D/4

4 mm²

Diodes terminal for lamp-test-circuits

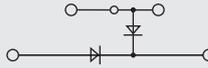

6 x 50 x 52.5	
10 / 4	
0.33 ... 4	

IEC	UL	CSA	EN 50019
380			
10			
4			
		/ 3	
		A3 / V2	

Rated connection		Additional connection	
1000 / 1			
	/ 1000		

Rated connection		Additional connection	
0.5...4 / 0.5...4			
0.5...4 / 0.5...4			
0.5...0.8 (M3)			
9 / 3.5 x 0.6			

Type	Voltage	Qty.	Order No.
DK 4/35 2D GET.SCH. A1	380 V	25	0396600000

Information

Type	Current [A]	Qty.	Order No.
Q 2 AKZ4	32	50	0336400000
Q 3 AKZ4	32	50	0336500000
Q 4 AKZ4	32	50	0336600000

Current [A]			
QB 2 WI RA6 IS	27	50	0482700000
QB 3 WI RA6 IS	27	50	0482800000
QB 4 WI RA6 IS	27	50	0482900000

AP DK4			
		20	0359260000

STB 8.5/D4/2.3/M2.5 AKZ			
		50	0215700000

PS 2.3 RT			
		20	0180400000

VH 10/4/2.8 AKZ4			
		50	0446600000

VL 2 AKZ4/DK4			
		50	0446700000

BFSC M2.5X14 SAKD2.5N			
		100	0266800000

TSCH 4 AKZ4			
		100	0363360000

DEK 6			

For detailed information on other accessories and applications see "Accessories"			

Modular terminals with electronic components

DK 4 D/5

4 mm²

Diodes terminal for lamp-test-circuits

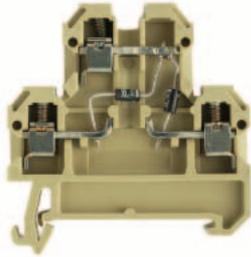

6 x 50 x 52.5
10 / 4
0.33 ... 4

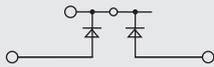

IEC	UL	CSA	EN 50019
380			
10			
4			



1000 / 1

/ 1000

Rated connection	Additional connection
0.5...4 / 0.5...4	
0.5...4 / 0.5...4	
0.5...0.8 (M3)	
9 / 3.5 x 0.6	

Type	Voltage	Qty.	Order No.
DK 4/35 2D GET.SCH. A2	380 V	25	0396860000

Type	Current [A]	Qty.	Order No.
Q 2 AKZ4	32	50	0336400000
Q 3 AKZ4	32	50	0336500000
Q 4 AKZ4	32	50	0336600000

	Current [A]	Qty.	Order No.
QB 2 WI RA6 IS	27	50	0482700000
QB 3 WI RA6 IS	27	50	0482800000
QB 4 WI RA6 IS	27	50	0482900000

AP DK4	20	0359260000
--------	----	------------

STB 8.5/D4/2.3/M2.5 AKZ	50	0215700000
-------------------------	----	------------

PS 2.3 RT	20	0180400000
-----------	----	------------

VH 10/4/2.8 AKZ4	50	0446600000
------------------	----	------------

VL 2 AKZ4/DK4	50	0446700000
---------------	----	------------

BFSC M2.5X14 SAKD2.5N	100	0266800000
-----------------------	-----	------------

TSCH 4 AKZ4	100	0363360000
-------------	-----	------------

DEK 6		
-------	--	--

DK 4 D/6

4 mm²

Diodes terminal for lamp-test-circuits



6 x 50 x 52.5
10 / 4
0.33 ... 4

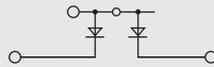

IEC	UL	CSA	EN 50019
380			
10			
4			



1000 / 1

/ 1000

Rated connection	Additional connection
0.5...4 / 0.5...4	
0.5...4 / 0.5...4	
0.5...0.8 (M3)	
9 / 3.5 x 0.6	

Type	Voltage	Qty.	Order No.
DK 4/35 2D GET.SCH. A1	380 V	25	0396760000

Type	Current [A]	Qty.	Order No.
Q 2 AKZ4	32	50	0336400000
Q 3 AKZ4	32	50	0336500000
Q 4 AKZ4	32	50	0336600000

	Current [A]	Qty.	Order No.
QB 2 WI RA6 IS	27	50	0482700000
QB 3 WI RA6 IS	27	50	0482800000
QB 4 WI RA6 IS	27	50	0482900000

AP DK4	20	0359260000
--------	----	------------

STB 8.5/D4/2.3/M2.5 AKZ	50	0215700000
-------------------------	----	------------

PS 2.3 RT	20	0180400000
-----------	----	------------

VH 10/4/2.8 AKZ4	50	0446600000
------------------	----	------------

VL 2 AKZ4/DK4	50	0446700000
---------------	----	------------

BFSC M2.5X14 SAKD2.5N	100	0266800000
-----------------------	-----	------------

TSCH 4 AKZ4	100	0363360000
-------------	-----	------------

DEK 6		
-------	--	--

DK 4 D/7

4 mm²

Diodes terminal for lamp-test-circuits with multiplier



6 x 50 x 52.5
10 / 4
0.33 ... 4

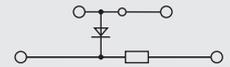

IEC	UL	CSA	EN 50019
24			
10			
4			



/ 1

/ 1000

Rated connection	Additional connection
0.5...4 / 0.5...4	
0.5...4 / 0.5...4	
0.5...0.8 (M3)	
9 / 3.5 x 0.6	

Type	Voltage	Qty.	Order No.
DK 4/35 1D 1K5 GET.SCH	24 V	25	0396960000

Type	Current [A]	Qty.	Order No.
Q 2 AKZ4	32	50	0336400000
Q 3 AKZ4	32	50	0336500000
Q 4 AKZ4	32	50	0336600000

	Current [A]	Qty.	Order No.
QB 2 WI RA6 IS	27	50	0482700000
QB 3 WI RA6 IS	27	50	0482800000
QB 4 WI RA6 IS	27	50	0482900000

AP DK4	20	0359260000
--------	----	------------

STB 8.5/D4/2.3/M2.5 AKZ	50	0215700000
-------------------------	----	------------

PS 2.3 RT	20	0180400000
-----------	----	------------

VH 10/4/2.8 AKZ4	50	0446600000
------------------	----	------------

VL 2 AKZ4/DK4	50	0446700000
---------------	----	------------

BFSC M2.5X14 SAKD2.5N	100	0266800000
-----------------------	-----	------------

TSCH 4 AKZ4	100	0363360000
-------------	-----	------------

DEK 6		
-------	--	--

Modular terminals with electronic components

With electronic components TS 35 / PA

DK 4 D/8

4 mm²

Diodes terminal for lamp-test-circuits with multiplier



When using ATEX certified components in hazardous area applications the installation instructions and the rated data for accessories in the technical appendix must be considered.

Width/Length/Height with TS35x7.5	mm
Max. current / max. cond. cross-section	A/mm ²
Max. clamping range	mm ²

6 x 50 x 52.5
10 / 4
0.33 ... 4

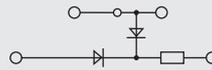

Technical data

Rated data	
Rated voltage	V
Rated current	A
Rated cross-section	mm ²
Rated impulse voltage / Pollution severity	kV/-
Plug gauge IEC 60-947-1 / flammability class acc. UL 94	
Approvals	

Electronic built-in components	
Diode current / diode voltage	V / A
voltage LED / current LED / polarity	V / mA / -
Resistance / Varistor	-/V

Clampable conductors (H05V/H07V)	
Solid / stranded	mm ²
Flexible / flexible w. wire end ferrule	mm ²
Tightening torque range (clamping screw)	Nm
Stripping length / blade size	mm / -

Information

IEC	UL	CSA	EN 50019
24			
10			
4			
		/ 3	
		A3 / V2	

/ 1

Rated connection	Additional connection
0.5...4 / 0.5...4	
0.5...4 / 0.5...4	
0.5...0.8 (M3)	
9 / 3.5 x 0.6	

Order data

Version	
Terminal components	LED red
see circuit diagram above	LED green
	Neon lamp
	Neon lamp

Information

Type	Voltage	Qty.	Order No.
DK 4/35 2D 1K5	24 V	25	0181560000

Accessories

Cross-connection, screwable	
	2-pole
	3-pole
	4-pole
(Q)	10-pole

External cross-connection	
	2-pole
	3-pole
	4-pole

End plate	
	beige

Socket

Test plug

Connecting sleeve

Cross-connection saddle

Fixing screw / Partition disc	
Fixing screw	
Partition disc	

Marking systems

For detailed information on other accessories and applications see "Accessories"

Type	Current [A]	Qty.	Order No.
Q 2 AKZ4	32	50	0336400000
Q 3 AKZ4	32	50	0336500000
Q 4 AKZ4	32	50	0336600000

Current [A]			
QB 2 WI RA6 IS	27	50	0482700000
QB 3 WI RA6 IS	27	50	0482800000
QB 4 WI RA6 IS	27	50	0482900000

AP DK4	20	0359260000
--------	----	------------

STB 8.5/D4/2.3/M2.5 AKZ	50	0215700000
-------------------------	----	------------

PS 2.3 RT	20	0180400000
-----------	----	------------

VH 10/4/2.8 AKZ4	50	0446600000
------------------	----	------------

VL 2 AKZ4/DK4	50	0446700000
---------------	----	------------

BFSC M2.5X14 SAKD2.5N	100	0266800000
-----------------------	-----	------------

TSCH 4 AKZ4	100	0363360000
-------------	-----	------------

DEK 6		
-------	--	--

Modular terminals with electronic components

With electronic components TS 35 / PA

When using ATEX certified components in hazardous area applications the installation instructions and the rated data for accessories in the technical appendix must be considered.

Width/Length/Height with TS35x7.5	mm
Max. current / max. cond. cross-section	A/mm ²
Max. clamping range	mm ²

Technical data

Rated data	
Rated voltage	V
Rated current	A
Rated cross-section	mm ²
Rated impulse voltage / Pollution severity	kV/-
Plug gauge IEC 60-947-1 / flammability class acc. UL 94	
Approvals	

Electronic built-in components

Diode current / diode voltage	V / A
voltage LED / current LED / polarity	V / mA / -
Resistance / Varistor	-/V

Clampable conductors (H05V/H07V)

Solid / stranded	mm ²
Flexible / flexible w. wire end ferrule	mm ²
Tightening torque range (clamping screw)	Nm
Stripping length / blade size	mm / -

Information

Order data

Version	
Terminal components	LED red
see circuit diagram above	LED green
	Neon lamp
	Neon lamp

Information

Accessories

Cross-connection, screwable

	2-pole	Q 2 AKZ4	32	50	0336400000
	3-pole	Q 3 AKZ4	32	50	0336500000
	4-pole	Q 4 AKZ4	32	50	0336600000
(Q)	10-pole	Q 10 AKZ4	32	20	0368600000

External cross-connection

	2-pole				
	3-pole				
	4-pole				

End plate

	beige	AP DK4	20	0359260000
--	-------	--------	----	------------

Socket

		STB 8.5/D4/2.3/M2.5 AKZ	50	0215700000
--	--	-------------------------	----	------------

Test plug

		PS 2.3 RT	20	0180400000
--	--	-----------	----	------------

Connecting sleeve

		VH 10/4/2.8 AKZ4	50	0446600000
--	--	------------------	----	------------

Cross-connection saddle

		VL 2 AKZ4/DK4	50	0446700000
--	--	---------------	----	------------

Fixing screw / Partition disc

	Fixing screw	BFSC M2.5X14 SAKD2.5N	100	0266800000
	Partition disc			

Marking systems

		DEK 6		
--	--	-------	--	--

For detailed information on other accessories and applications see "Accessories"

DK 4 RC

4 mm²

Terminal with RC



18 x 650 x 52.5

10 / 4

0.33 ... 4

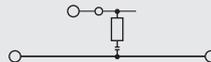

IEC	UL	CSA	EN 50019
250			
10			
4			

Rated connection

0.5...4 / 0.5...4

0.5...4 / 0.5...2.5

0.5...0.8 (M 3)

9 / 3.5 x 0.6

Additional connection

DK 4 PT 100

4 mm²

Diodes terminal for central control systems



6 x 65 x 53.5

10 / 4

0.33 ... 4

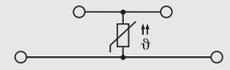

IEC	UL	CSA	EN 50019
10			
4			
		/ 3	
		A3 / V2	

Rated connection

0.5...4 / 0.5...4

0.5...4 / 0.5...2.5

0.4...0.7 (M 2.5)

6 / 3.5 x 0.6

Additional connection

Type	Voltage	Qty.	Order No.
DK 4/35 RC 220R/220N	230 V	5	0053160000

Type	Voltage	Qty.	Order No.
DKT 4/35 PT100		10	8014720000

Type	Current [A]	Qty.	Order No.
Q 2 AKZ4	32	50	0336400000
Q 3 AKZ4	32	50	0336500000
Q 4 AKZ4	32	50	0336600000

Type	Current [A]	Qty.	Order No.
QB 2 WI RA6 IS	27	50	0482700000
QB 3 WI RA6 IS	27	50	0482800000
QB 4 WI RA6 IS	27	50	0482900000

Type	Current [A]	Qty.	Order No.
AP DK4		20	0359260000

Type	Current [A]	Qty.	Order No.
AP DKT4 PA		20	0687560000

Type	Current [A]	Qty.	Order No.
STB 8.5/D4/2.3/M2.5 AKZ		50	0215700000

Type	Current [A]	Qty.	Order No.
PS 2.3 RT		20	0180400000

Type	Current [A]	Qty.	Order No.
VH 10/4/2.8 AKZ4		50	0446600000

Type	Current [A]	Qty.	Order No.
VL 2 AKZ4/DK4		50	0446700000

Type	Current [A]	Qty.	Order No.
BFSC M2.5X14 SAKD2.5N		100	0266800000

Type	Current [A]	Qty.	Order No.
TSCH 4 AKZ4		100	0363360000

Type	Current [A]	Qty.	Order No.
DEK 6			

Type	Current [A]	Qty.	Order No.
DEK 6			

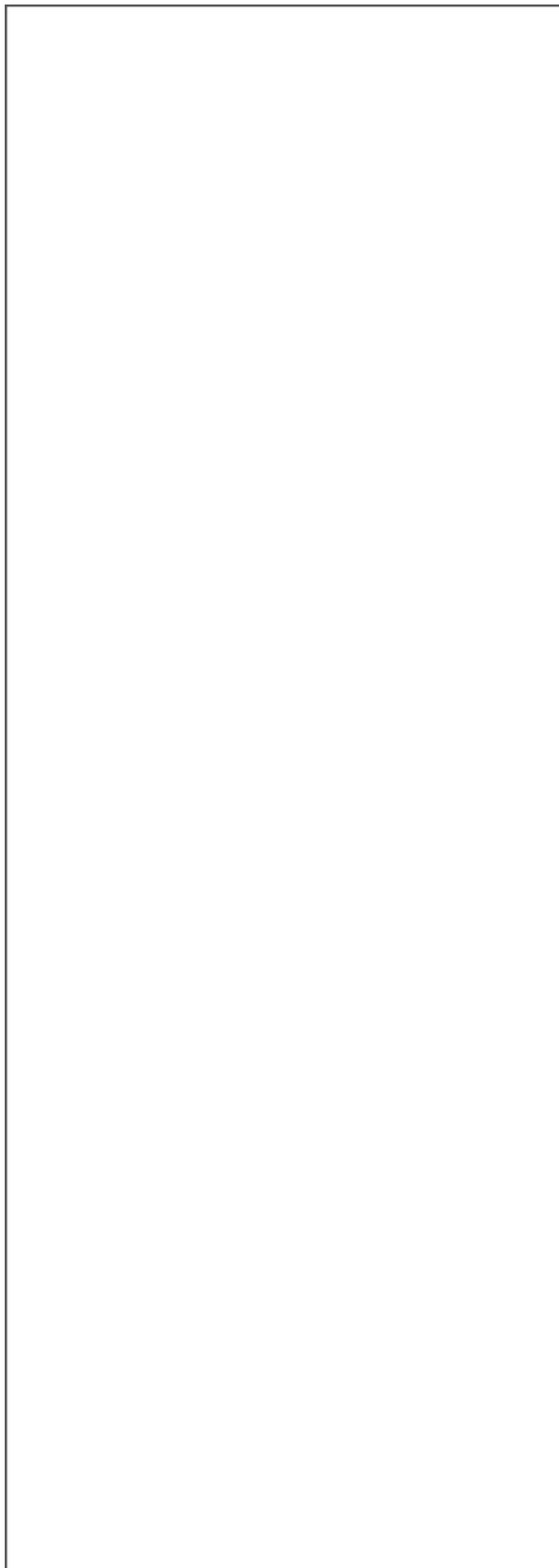

Modular feed-through terminal		
TS 32 / PA	B.2	- B.5
TS 32 / KrG	B.6	- B.9
Modular 2-tier terminals		
TS 32 / PA	B.10	- B.11
Modular PE terminals		
TS 32 / PA	B.12	- B.13
TS 32	B.14	- B.15
Disconnect terminals		
TS 32 / PA	B.16	- B.17
TS 32 / KrG	B.18	- B.19
Fuse terminals		
TS 32 / PA	B.20	- B.21
TS 32 / KrG	B.22	- B.25
Fuse inserts and gauge rings for Weidmüller fuse terminals	B.26	- B.27
Spring Loaded Terminal		
TS 32	B.28	- B.29
Modular disconnect test terminals		
TS 32 / KrG	B.30	- B.33
Feed-through terminals for thermocouples		
TS 32 / PA	B.34	- B.35
Modular terminals with screwless connections		
With puls-on connection		
TS 32 / PA	B.36	- B.38
With Termi-Point/Wire-Wrap connection		
TS 32/PA	B.39	
With solder connection		
TS 32/PA	B.40	- B.43
With puls-on connection		
TS 32/KrG	B.44	- B.46
With Termi-Point/Wire-Wrap connection		
TS 32/KrG	B.47	- B.48
With solder connection		
TS 32/KrG	B.49	- B50
Bolt-type screw terminal - SAKG		
TS 32 / KRG	B.52	- B.59
Stud terminal - KST		
TS 32 / PA	B.60	- B.61
Modular terminals with electronic components		
TS 32 / PA	B.62	- B.70

Modular feed-through terminal

TS 32 / PA

SAKD 2.5N

2.5 mm²

SAK 2.5

2.5 mm²

TS 32 / PA

B

When using ATEX certified components in hazardous area applications the installation instructions and the rated data for accessories in the technical appendix must be considered.

Width/Length/Height with TS32	mm
Max. current / max. cond. cross-section	A/mm ²
Max. clamping range	mm ²

5 x 32.5 x 43.5	
30 / 4	
0.08 ... 4	

6 x 36.5 x 46.5	
41 / 6	
0.13 ... 6	

Technical data

Rated data	
Rated voltage	V
Rated current	A
Rated cross-section	mm ²
Rated impulse voltage / Pollution severity	kV/-
Plug gauge IEC 60-947-1 / flammability class acc. UL 94 Approvals	
Clampable conductors (H05V/H07V)	
Solid / stranded	mm ²
Flexible / flexible w. wire end ferrule	mm ²
Tightening torque range (clamping screw)	Nm
Stripping length / blade size	mm / -
2 clampable conductors of equal cross-section	
Solid / stranded	mm ²
Flexible / flexible w. wire end ferrule	mm ²
Information	

IEC 60947-7-1			
IEC	UL	CSA	EN 50019
500	300	300	
24	20	20	
2.5	AWG 28...12	AWG 22...12	
6 / 3			
A2 / V2			
Rated connection		Additional connection	
0.5...4 / 0.5...2.5			
0.5...4 / 0.5...2.5			
0.4...0.6 (M 2.5)			
10 / 3.5 x 0.6			
Use of twin wire end ferrules on request			

IEC 60947-7-1				EEx e II	II 2 G D
IEC	UL	CSA	EN 50019		
800	600	600	550		
24	20	25	21		
2.5	AWG 22...12	AWG 26...10	2.5		
8 / 3					
A3 / V2					
Rated connection		Additional connection			
0.5...6 / 0.5...4					
0.5...4 / 0.5...4					
0.4...0.6 (M 2.5)					
10 / 3.5 x 0.6					
...1.5					
The rated voltage is 690 V when using wire end ferrules without end cover or partition plates.					

Order data

Version	
	beige
	blue
Information	

Type	Qty.	Order No.
SAKD 2.5N	100	0215560000
SAKD 2.5N BL	100	0215580000

Type	Qty.	Order No.
SAK 2.5	100	0279660000
SAK 2.5 BL	100	0279680000

Accessories

Cross-connection, screwable	
	2-pole
	3-pole
	4-pole
	10-pole
	Connecting sleeve
	Fixing screw
	Fuse cartridges
Cross-connection saddle	
	Cross-connection saddle
	Connecting sleeve
	Fixing screw
Socket / Test plug	
	Socket
	Test plug
End plate	
	beige
	blue
Partition / Partition disc	
	beige
	blue
	Partition disc
Cover / fixing screw (plastic)	
	Cover
	Fixing screw (plastic)
Marking systems	
	DEK 5
Detailed information on all versions in chapter accessories.	

Type	Current [A]	Qty.	Order No.
Q 2 SAKD2.5N	24	50	0367800000
Q 3 SAKD2.5N	24	50	0367900000
Q 4 SAKD2.5N	24	50	0368000000
Q 10 SAKD2.5N	24	20	0368100000
Width [mm]			
AP SAKD2.5N	1.5	20	1509600000
AP SAKD2.5N BL	1.5	20	0150980000
Width [mm]			
TW SAKD2.5N	1.5	20	1918600000
TW SAKD2.5N BL	1.5	20	0191880000
TSCH 3 SAKD2.5 N	5	100	0366860000

Type	Current [A]	Qty.	Order No.
Q 2 SAK2.5	41	50	0337000000
Q 3 SAK2.5	41	50	0337100000
Q 4 SAK2.5	41	50	0337200000
Q 10 SAK2.5	41	20	0368700000
Width [mm]			
AP SAK2.5	1.5	20	0279560000
AP SAK2.5 BL	1.5	20	0279580000
Width [mm]			
TW SAK2.5	2.5	20	0302860000
TW SAK2.5 BL	1.5	20	0302880000
TSCH 1	2	100	0319160000
AD 3 SAK2.5		50	0297900000
BFSC M3X22 PA/RT		100	0128900000
Width [mm]			
DEK 6			

Modular feed-through terminal

SAK 4

4 mm²

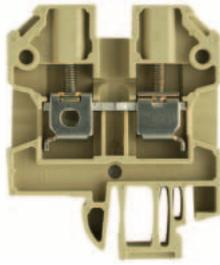

6.5 x 40 x 51.5
41 / 6
0.13 ... 6

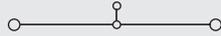

IEC 60947-7-1

EEx e II II 2 G D

IEC	UL	CSA	EN 50019
800	600	600	550
32	20	36	28
4	AWG 22...12	AWG 26...10	4
8 / 3			
A4 / V2			



KEMA 97ATEX1798 U

Rated connection	Additional connection
0.5...6 / 0.5...4	
0.5...4 / 0.5...4	
0.5...1.0 (M 3)	
12 / 3.5 x 0.6	

1.5...1.5
0.5...1.5

The rated voltage is reduced to 690 V when using wire end ferrules.

SAK 6 N

6 mm²



8 x 40 x 51.5
57 / 10
0.2 ... 10

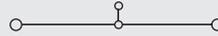

IEC 60947-7-1

EEx e II II 2 G D

IEC	UL	CSA	EN 50019
800	600	600	550
41	40	47	36
6	AWG 22...8	AWG 20...8	6
8 / 3			
A5 / V2			



KEMA 97ATEX1798 U

Rated connection	Additional connection
0.5...10 / 0.5...6	
0.5...10 / 0.5...6	
0.8...1.6 (M 3.5)	
12 / 4.0 x 0.8	

The rated voltage is reduced to 690 V when using wire end ferrules.

SAK 10

10 mm²

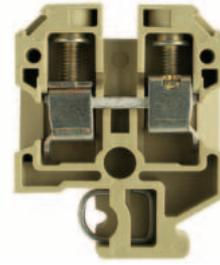

10 x 40 x 51.5
76 / 16
1.5 ... 16

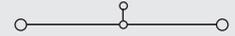

IEC 60947-7-1

EEx e II II 2 G D

IEC	UL	CSA	EN 50019
800	600	600	550
57	60	65	50
10	AWG 16...6	AWG 14...6	10
8 / 3			
B6 / V2			



KEMA 97ATEX1798 U

Rated connection	Additional connection
1.5...10 / 1.5...16	
1.5...16 / 1.5...10	
2.0...2.4 (M 4)	
12 / 5.5 x 1.0	

Tightening torque 2 Nm for 10 and 16 mm² stranded and AWG 6/7 wire.

Type	Qty.	Order No.
SAK 4	100	1716240000
SAK 4 BL	100	0128380000

Type	Qty.	Order No.
SAK 6N	100	0193260000
SAK 6N BL	100	0193280000

Type	Qty.	Order No.
SAK 10	100	0110060000
SAK 10 BL	100	0110080000

Type	Current [A]	Qty.	Order No.
Q 2 SAK4	41	50	0336700000
Q 3 SAK4	41	50	0336800000
Q 4 SAK4	41	50	0336900000
Q 10 SAK4	41	20	0368800000

Type	Current [A]	Qty.	Order No.
Q 2 SAK6N	57	50	0456700000
Q 3 SAK6N	57	50	0456800000
Q 4 SAK6N	57	50	0456900000
Q 10 SAK6N	57	20	0457000000

Type	Current [A]	Qty.	Order No.
Q 2 SAK10	57	50	0457100000
Q 3 SAK10	57	50	0457200000
Q 4 SAK10	57	50	0457300000
Q 10 SAK10	57	20	0457400000

VL 2 SAK4	50	0197000000
VH 19/5/3.5 SAK4-16	50	0285100000
BFSC M3X25	100	0292500000

VL 2 SAK6/10/SAKB	50	0135900000
VH 19/5/3.5 SAK4-16	50	0285100000
BFSC M3X25	100	0292500000

VL 2 SAK6/10/SAKB	50	0135900000
VH 19/5/3.5 SAK4-16	50	0285100000
BFSC M3X25	100	0292500000

STB 14/D5/2.3/M3 SAK2.5	50	0168600000
PS 4 F.STB 4	20	0299600000

STB 14/D6/4/M3 SAK10	50	0169900000
PS 4 F.STB 4	20	0299600000

STB 14/D6/4/M3 SAK10	50	0169900000
PS 4 F.STB 4	20	0299600000

Width [mm]			
AP SAK4-10	1.5	20	0117960000
AP SAK4-10 BL	1.5	20	0117980000

Width [mm]			
AP SAK4-10	1.5	20	0117960000
AP SAK4-10 BL	1.5	20	0117980000

Width [mm]			
AP SAK4-10	1.5	20	0117960000
AP SAK4-10 BL	1.5	20	0117980000

Width [mm]			
TW 4 SAK4-10	1.5	20	0130160000
TW 4 SAK4-10 BL	1.5	20	0130180000
TSCH 1	2	100	0319160000

Width [mm]			
TW 4 SAK4-10	1.5	20	0130160000
TW 4 SAK4-10 BL	1.5	20	0130180000
TSCH 1	2	100	0319160000

Width [mm]			
TW 4 SAK4-10	1.5	20	0130160000
TW 4 SAK4-10 BL	1.5	20	0130180000
TSCH 1	2	100	0319160000

AD 4 SAK4	50	0285300000
BFSC M3X22 PA/RT	100	0128900000

AD 4 SAK6N	50	0196600000
BFSC M3X22 PA/RT	100	0128900000

AD 4 SAK10	50	0178600000
BFSC M3X22 PA/RT	100	0128900000

DEK 6,5

DEK 8

DEK 5

Modular feed-through terminal

TS 32 / PA

SAK 16

16 mm²

SAK 35

35 mm²

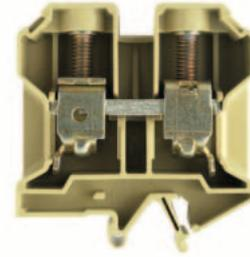
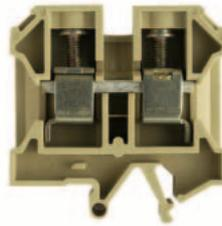

When using ATEX certified components in hazardous area applications the installation instructions and the rated data for accessories in the technical appendix must be considered.

Width/Length/Height with TS32	mm
Max. current / max. cond. cross-section	A/mm ²
Max. clamping range	mm ²

12 x 50 x 57.5	
76 / 16	
2.5 ... 16	

18 x 58 x 67.5	
150 / 50	
2.5 ... 50	

Technical data

Rated data	
Rated voltage	V
Rated current	A
Rated cross-section	mm ²
Rated impulse voltage / Pollution severity	kV/-
Plug gauge IEC 60-947-1 / flammability class acc. UL 94	
Approvals	
Clampable conductors (H05V/H07V)	
Solid / stranded	mm ²
Flexible / flexible w. wire end ferrule	mm ²
Tightening torque range (clamping screw)	Nm
Stripping length / blade size	mm / -
2 clampable conductors of equal cross-section	
Solid / stranded	mm ²
Flexible / flexible w. wire end ferrule	mm ²
Information	

IEC 60947-7-1				EEx e II II 2 G D			
IEC	UL	CSA	EN 50019				
1000	600	600	750				
76	80	87	66				
16	AWG 12...6	AWG 10...6	16				
				8 / 3			
				B6 / V2			
				KEMA 97ATEX1798 U			
Rated connection		Additional connection					
2.5...10 / 4...16							
4...16 / 4...16							
2.0...2.4 (M4)							
15 / 5.5 x 1.0							
Installation of the QL side by side use a TW/AP.							

IEC 60947-7-1				EEx e II II 2 G D			
IEC	UL	CSA	EN 50019				
1000	600	600	550				
125	100	145	109				
35	AWG 12...2	AWG 12...2	35				
				8 / 3			
				B8 / V2			
				KEMA 97ATEX1798 U			
Rated connection		Additional connection					
2.5...16 / 4...50							
2.5...35 / 2.5...35							
4.0...5.0 (M6)							
18 / 6.5 x 1.2							
...10 / 10...16							
2.5...16 / 2.5...16							
Installation of the QL side by side use a TW/AP.							

Order data

Version	
	beige
	blue
Information	

Type	Qty.	Order No.
SAK 16	50	0271060000
SAK 16 BL	50	0271080000

Type	Qty.	Order No.
SAK 35	20	0303560000
SAK 35 BL	20	0303580000

Accessories

Cross-connection, screwable	
	(Q)
2-pole	
3-pole	
4-pole	
10-pole	
Connecting sleeve	
Fixing screw	
Fuse cartridges	
Cross-connection saddle	
Cross-connection saddle	
Connecting sleeve	
Fixing screw	
Socket / Test plug	
Socket	
Test plug	
End plate	
beige	
blue	
Partition / Partition disc	
beige	
blue	
Partition disc	
Cover / fixing screw (plastic)	
Cover	
Fixing screw (plastic)	
Marking systems	
Detailed information on all versions in chapter accessories.	

Type	Current [A]	Qty.	Order No.
Q 2 SAK16	76	50	0457500000
Q 3 SAK16	76	50	0457600000
Q 4 SAK16	76	50	0457700000
Q 10 SAK16	76	20	0457800000
Cross-connection saddle			
VL 2 SAK16/SAKA	50	0135800000	
VH 19/5/3.5 SAK4-16	50	0285100000	
BFSC M3X25	100	0292500000	
Socket / Test plug			
STB 14/D6/4/M3 SAK10	50	0169900000	
PS 4 F.STB 4	20	0299600000	
End plate			
Width [mm]			
AP SAK35/TW SAK16	1.5	10	0303660000
AP SAK35/TW SAK16 BL	1.5	10	0303680000
Partition / Partition disc			
Width [mm]			
TSCH 1	2	100	0319160000
Cover / fixing screw (plastic)			
AD 3 SAK16	50	0297800000	
BFSC M3X22 PA/RT	100	0128900000	
Marking systems			
DEK 5			

Type	Current [A]	Qty.	Order No.
QL 2 SAK35	99	20	0123600000
QL 3 SAK35	99	20	0123700000
QL 4 SAK35	99	20	0123800000
QL 10 SAK35	99	20	0338600000
VH 17/8/5 SAK35	50	0267000000	
BFSC M4X30	50	0267100000	
SS M4 D 128-A 4	100	0136400000	
Cross-connection saddle			
VL 2 SAK35	50	0124000000	
VH 24.5/8/5 SAK35	50	0298700000	
BFSC M4X35	50	0298900000	
Socket / Test plug			
STB 16/D7/4/M4 SAK35	50	0140200000	
PS 4 F.STB 4	20	0299600000	
End plate			
Width [mm]			
AP SAK35/TW SAK16	1.5	10	0303660000
AP SAK35/TW SAK16 BL	1.5	10	0303680000
Partition / Partition disc			
Width [mm]			
TW SAK35	1.5	20	0304360000
Cover / fixing screw (plastic)			
AD 3 SAK35	50	0273400000	
BFSC M4X32 PA/RT	100	0129100000	
Marking systems			
DEK 5			

Modular feed-through terminal

SAK 35/IK

35 mm²

Hexagon socket head screw



18 x 58 x 67.5
150 / 50
2.5 ... 50

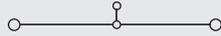

IEC 60947-7-1

EEx e II II 2 G D

IEC	UL	CSA	EN 50019
1000	600	600	550
125	100	145	109
35	AWG 12...2	AWG 12...2	35
8 / 3			
B8 / V2			



KEMA 97ATEX1798 U

Rated connection	Additional connection
2.5...16 / 4...50	
2.5...35 / 2.5...35	
4.0...5.0 (M 6)	
18 / S 4 (DIN6911)	

2.5...10 / 10...16
2.5...16 / 2.5...16

Installation of the QL side by side use a TW/AP.

Type	Qty.	Order No.
SAK 35/IK	20	0476560000

SAK 35 N

35 mm²



16 x 58 x 67.5
150 / 50
2.5 ... 50

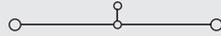

IEC 60947-7-1

IEC	UL	CSA	EN 50019
1000	600	600	
125	100	120	
35	AWG 12...2	AWG 12...2	
8 / 3			
B8 / V2			



Rated connection	Additional connection
2.5...16 / 4...50	
2.5...35 / 1.5...35	
4.0...5.0 (M 6)	
18 / 6.5 x 1.2	

2.5...10 / 10...16
2.5...16 / 2.5...16

Installation of the QL side by side use a TW/AP.

Type	Qty.	Order No.
SAK 35N	20	0550660000

SAK 35 N/IK

35 mm²

Hexagon socket head screw



16 x 58 x 67.5
150 / 50
2.5 ... 50

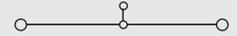

IEC 60947-7-1

IEC	UL	CSA	EN 50019
1000	600	600	
125	100	120	
35	AWG 12...2	AWG 12...2	
8 / 3			
B8 / V2			



Rated connection	Additional connection
2.5...16 / 4...50	
2.5...35 / 1.5...35	
4.0...6.0 (M 6)	
18 / S 4 (6911)	

2.5...10 / 10...16
2.5...16 / 2.5...16

Installation of the QL side by side use a TW/AP.

Type	Qty.	Order No.
SAK 35N/IK	20	0555760000

Type	Current [A]	Qty.	Order No.
QL 2 SAK35	99	20	0123600000
QL 3 SAK35	99	20	0123700000
QL 4 SAK35	99	20	0123800000
QL 10 SAK35	99	20	0338600000
VH 17/8/5 SAK35	50	50	0267000000
BFSC M4X30	50	50	0267100000
SS M4 D 128-A 4	100	100	0136400000

VL 2 SAK35	50	0124000000
VH 24.5/8/5 SAK35	50	0298700000
BFSC M4X35	50	0298900000

STB 16/D7/4/M4 SAK35	50	0140200000
PS 4 F.STB 4	20	0299600000

Width [mm]			
AP SAK35/TW SAK16	1.5	10	0303660000

Width [mm]			
TW SAK35	1.5	20	0304360000

AD 4 SAK35	50	0178700000
BFSC M4X32 PA/RT	100	0129100000

DEK 5

Type	Current [A]	Qty.	Order No.
QL 2 SAK35N	99	50	0564900000
QL 3 SAK35N	99	50	0565000000
QL 4 SAK35N	99	50	0565100000
QL 10 SAK35N	99	20	0565200000
VH 17/8/5 SAK35	50	50	0267000000
BFSC M4X30	50	50	0267100000
SS M4 D 128-A 4	100	100	0136400000

STB 16/D7/4/M4 SAK35	50	0140200000
PS 4 F.STB 4	20	0299600000

Width [mm]			
AP SAK35/TW SAK16	1.5	10	0303660000
AP SAK35/TW SAK16 BL	1.5	10	0303680000

Width [mm]			
TW SAK35	1.5	20	0304360000

AD 4 SAK35N	50	0576700000
BFSC M4X32 PA/RT	100	0129100000

DEK 5

Type	Current [A]	Qty.	Order No.
QL 2 SAK35N	99	50	0564900000
QL 3 SAK35N	99	50	0565000000
QL 4 SAK35N	99	50	0565100000
QL 10 SAK35N	99	20	0565200000
VH 17/8/5 SAK35	50	50	0267000000
BFSC M4X30	50	50	0267100000
SS M4 D 128-A 4	100	100	0136400000

STB 16/D7/4/M4 SAK35	50	0140200000
PS 4 F.STB 4	20	0299600000

Width [mm]			
AP SAK35/TW SAK16	1.5	10	0303660000

Width [mm]			
TW SAK35	1.5	20	0304360000

AD 4 SAK35N	50	0576700000
BFSC M4X32 PA/RT	100	0129100000

DEK 5

Modular feed-through terminal

TS 32 / KRG

SAK 2.5

2.5 mm²

SAK 4

4 mm²

TS 32 / KRG

B

When using ATEX certified components in hazardous area applications the installation instructions and the rated data for accessories in the technical appendix must be considered.

Width/Length/Height with TS32	mm
Max. current / max. cond. cross-section	A/mm ²
Max. clamping range	mm ²

6 x 36.5 x 46.5	
32 / 6	
0.13 ... 6	

6.5 x 40 x 51.5	
41 / 6	
0.13 ... 6	

Technical data

Rated data	
Rated voltage	V
Rated current	A
Rated cross-section	mm ²
Rated impulse voltage / Pollution severity	kV/-
Plug gauge IEC 60-947-1 / flammability class acc. UL 94	
Approvals	
Clampable conductors (H05V/H07V)	
Solid / stranded	mm ²
Flexible / flexible w. wire end ferrule	mm ²
Tightening torque range (clamping screw)	Nm
Stripping length / blade size	mm / -
2 clampable conductors of equal cross-section	
Solid / stranded	mm ²
Flexible / flexible w. wire end ferrule	mm ²
Information	

IEC 60947-7-1				EEx e II II 2 G D			
IEC	UL	CSA	EN 50019				
800	600	600	550				
24	20	25	21				
2.5	AWG 22...12	AWG 26...10	2.5				
				8 / 3			
				A3 / 5VA			
				KEMA 97ATEX1798 U			
Rated connection		Additional connection					
0.5...6 / 0.5...4							
0.5...4 / 0.5...2.5							
0.4...0.6 (M 2.5)							
10 / 3.5 x 0.6							
				The rated voltage is 630/690 V when using wire end ferrules without end cover or partition plates.			

IEC 60947-7-1				EEx e II II 2 G D			
IEC	UL	CSA	EN 50019				
800	600	600	550				
32	20	36	28				
4	AWG 22...12	AWG 26...10	4				
				8 / 3			
				A4 / 5VA			
				KEMA 97ATEX1798 U			
Rated connection		Additional connection					
0.5...6 / 0.5...4							
0.5...4 / 0.5...4							
0.5...1.0 (M 3)							
12 / 3.5 x 0.6							
				The rated voltage is reduced to 630/690 V when using wire end ferrules.			

Order data

Version	
yellow	
blue	
Information	

Type	Qty.	Order No.
SAK 2.5 KRG	100	0279620000
SAK 2.5 KRG/BL	100	0279670000
Information		

Type	Qty.	Order No.
SAK 4 KRG	100	0128320000
SAK 4 KRG BL	100	0128370000
Information		

Accessories

Cross-connection, screwable	
	2-pole
	3-pole
	4-pole
	10-pole
	Connecting sleeve
	Fixing screw
	Fuse cartridges
Cross-connection saddle	
	Cross-connection saddle
	Connecting sleeve
	Fixing screw
Socket / Test plug	
	Socket
	Test plug
End plate	
	yellow
	blue
Partition / Partition disc	
	yellow
	blue
	Partition disc
Cover / fixing screw (plastic)	
	Cover
	Fixing screw (plastic)
Marking systems	
Detailed information on all versions in chapter accessories.	

Type	Current [A]	Qty.	Order No.
Q 2 SAK2.5	41	50	0337000000
Q 3 SAK2.5	41	50	0337100000
Q 4 SAK2.5	41	50	0337200000
Q 10 SAK2.5	41	20	0368700000
Width [mm]			
AP SAK2.5 KRG	1.5	20	0279520000
AP SAK2.5 KRG BL	1.5	20	0279570000
Width [mm]			
TW SAK2.5 KRG	2.5	20	0302820000
TW SAK2.5 KRG/BL	2.5	20	0302870000
TSCH 1	2	100	0319160000
AD 4 AKZ4		50	0303400000
BFSC M3X22 PA/RT		100	0128900000
DEK 6			

Type	Current [A]	Qty.	Order No.
Q 2 SAK4	41	50	0336700000
Q 3 SAK4	41	50	0336800000
Q 4 SAK4	41	50	0336900000
Q 10 SAK4	41	20	0368800000
VL 2 SAK4		50	0197000000
VH 19/5/3.5 SAK4-16		50	0285100000
BFSC M3X25		100	0292500000
STB 14/D5/2.3/M3 SAK2.5		50	0168600000
PS 2.3 RT		20	0180400000
Width [mm]			
AP SAK4-10 KRG	1.5	20	0117920000
AP SAK4-10 KRG/BL	1.5	20	0117970000
Width [mm]			
TW SAK4-10 KRG	2.5	20	0130120000
TW SAK4-10 KRG/BL	2.5	20	0130170000
TSCH 1	2	100	0319160000
AD 4 SAK4		50	0285300000
BFSC M3X22 PA/RT		100	0128900000
DEK 6,5			

Modular feed-through terminal

SAK 6 N

6 mm²

SAK 10

10 mm²

SAK 16

16 mm²

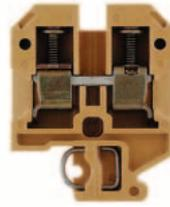
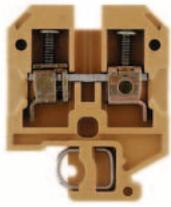

8 x 40 x 51.5
57 / 10
0.2 ... 10

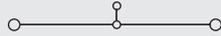

10 x 40 x 51.5
76 / 16
1.5 ... 16

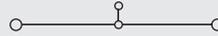

12 x 50 x 57.5
76 / 16
2.5 ... 16

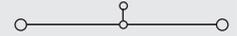

IEC 60947-7-1 EEx e II II 2 G D

IEC	UL	CSA	EN 50019
800	600	600	550
41	40	47	36
6	AWG 22...8	AWG 20...8	6
8 / 3			
A5 / 5VA			



KEMA 97ATEX1798 U

Rated connection	Additional connection
0.5...10 / 0.5...6	
0.5...10 / 0.5...6	
0.8...1.6 (M 3.5)	
12 / 4.0 x 0.8	

IEC 60947-7-1 EEx e II II 2 G D

IEC	UL	CSA	EN 50019
800	600	600	550
57	60	65	50
10	AWG 16...6	AWG 14...6	10
8 / 3			
B6 / 5VA			



KEMA 97ATEX1798 U

Rated connection	Additional connection
1.5...10 / 1.5...16	
1.5...16 / 1.5...10	
2.0...2.4 (M 4)	
12 / 5.5 x 1.0	

IEC 60947-7-1 EEx e II II 2 G D

IEC	UL	CSA	EN 50019
1000	600	600	750
76	80	87	66
16	AWG 12...6	AWG 10...6	16
8 / 3			
B6 / 5VA			



KEMA 97ATEX1798 U

Rated connection	Additional connection
2.5...10 / 4...16	
4...16 / 4...16	
2.0...2.4 (M 4)	
15 / 5.5 x 1.0	

The rated voltage is reduced to 630/690 V when using wire end ferrules.

Tightening torque 2 Nm for 10 and 16 mm² stranded and AWG 6/7 wire.

Installation of the QL side by side use a TW/AP.

Type	Qty.	Order No.
SAK 6N KRG	100	0193220000
SAK 6N KRG/BL	100	0193270000

Type	Qty.	Order No.
SAK 10 KRG	100	0110020000
SAK 10 KRG/BL	100	0110070000

Type	Qty.	Order No.
SAK 16 KRG	50	0271020000

Type	Current [A]	Qty.	Order No.
Q 2 SAK6N	57	50	0456700000
Q 3 SAK6N	57	50	0456800000
Q 4 SAK6N	57	50	0456900000
Q 10 SAK6N	57	20	0457000000

Type	Current [A]	Qty.	Order No.
Q 2 SAK10	57	50	0457100000
Q 3 SAK10	57	50	0457200000
Q 4 SAK10	57	50	0457300000
Q 10 SAK10	57	20	0457400000

Type	Current [A]	Qty.	Order No.
Q 2 SAK16	76	50	0457500000
Q 3 SAK16	76	50	0457600000
Q 4 SAK16	76	50	0457700000
Q 10 SAK16	76	20	0457800000

VL 2 SAK6N/SAKT	50	0194700000
VH 19/5/3.5 SAK4-16	50	0285100000
BFSC M3X25	100	0292500000

VL 2 SAK6/10/SAKB	50	0135900000
VH 19/5/3.5 SAK4-16	50	0285100000
BFSC M3X25	100	0292500000

VL 2 SAK16/SAKA	50	0135800000
VH 19/5/3.5 SAK4-16	50	0285100000
BFSC M3X25	100	0292500000

PS 4 F.STB 4	20	0299600000
--------------	----	------------

STB 14/D6/4/M3 SAK10	50	0169900000
PS 4 F.STB 4	20	0299600000

STB 14/D6/4/M3 SAK10	50	0169900000
PS 4 F.STB 4	20	0299600000

Width [mm]			
AP SAK4-10 KRG	1.5	20	0117920000
AP SAK4-10 KRG/BL	1.5	20	0117970000

Width [mm]			
AP SAK4-10 KRG	1.5	20	0117920000
AP SAK4-10 KRG/BL	1.5	20	0117970000

Width [mm]			
AP SAK16 KRG	3	20	0271120000
AP SAK35/TW SAK16 BL	1.5	10	0303680000

Width [mm]			
TW SAK4-10 KRG	2.5	20	0130120000
TW SAK4-10 KRG/BL	2.5	20	0130170000
TSCH 1	2	100	0319160000

Width [mm]			
TW SAK4-10 KRG	2.5	20	0130120000
TW SAK4-10 KRG/BL	2.5	20	0130170000
TSCH 1	2	100	0319160000

Width [mm]			
TW SAK16 KRG	3	20	0281120000
TSCH 1	2	100	0319160000

AD 4 SAK6N	50	0196600000
BFSC M3X22 PA/RT	100	0128900000

AD 4 SAK10	50	0178600000
BFSC M3X22 PA/RT	100	0128900000

AD 4 SAK16	50	0518200000
BFSC M3X22 PA/RT	100	0128900000

DEK 8

DEK 5

DEK 5

Modular feed-through terminal

TS 32 / KRG

SAK 35

35 mm²

SAK 35/IK

35 mm²

TS 32 / KRG

B

When using ATEX certified components in hazardous area applications the installation instructions and the rated data for accessories in the technical appendix must be considered.

Width/Length/Height with TS32	mm
Max. current / max. cond. cross-section	A/mm ²
Max. clamping range	mm ²

18 x 58 x 67.5	
125 / 50	
6 ... 50	

18 x 58 x 67.5	
125 / 50	
6 ... 50	

Technical data

Rated data	
Rated voltage	V
Rated current	A
Rated cross-section	mm ²
Rated impulse voltage / Pollution severity	kV/-
Plug gauge IEC 60-947-1 / flammability class acc. UL 94 Approvals	

IEC 60947-7-1				EEx e II Ex II 2 G D			
IEC	UL	CSA	EN 50019	IEC	UL	CSA	EN 50019
1000	600	600	550	1000	600	600	550
125	100	145	109	125	100	145	109
35	AWG 6...2	AWG 6...2	35	35	AWG 6...2	AWG 6...2	35
				8 / 3			
				B9 / 5VA			

IEC 60947-7-1				EEx e II Ex II 2 G D			
IEC	UL	CSA	EN 50019	IEC	UL	CSA	EN 50019
1000	600	600	550	1000	600	600	550
125	100	145	109	125	100	145	109
35	AWG 6...2	AWG 6...2	35	35	AWG 6...2	AWG 6...2	35
				8 / 3			
				B9 / 5VA			

Clampable conductors (H05V/H07V)	
Solid / stranded	mm ²
Flexible / flexible w. wire end ferrule	mm ²
Tightening torque range (clamping screw)	Nm
Stripping length / blade size	mm / -

Rated connection	Additional connection
6...16 / 16...50	
10...35 / 10...35	
5,0 (M 6)	
20 / 6.5 x 1.2	

Rated connection	Additional connection
6...16 / 16...50	
10...35 / 10...35	
5,0 (M 6)	
20 / S 4 (DIN 6911)	

2 clampable conductors of equal cross-section	
Solid / stranded	mm ²
Flexible / flexible w. wire end ferrule	mm ²

Installation of the QL side by side use a TW/AP.	

Installation of the QL side by side use a TW/AP.	

Information

Installation of the QL side by side use a TW/AP.

Installation of the QL side by side use a TW/AP.

Order data

Version	
	yellow
	blue

Type	Qty.	Order No.
SAK 35 KRG	20	0303520000

Type	Qty.	Order No.
SAK 35/IK KRG	20	0476520000

Information

Accessories

Cross-connection, screwable	
	
	(Q)
	2-pole
	3-pole
	4-pole
	10-pole
	Connecting sleeve
	Fixing screw
	Fuse cartridges

Type	Current [A]	Qty.	Order No.
QL 2 SAK35	99	20	0123600000
QL 3 SAK35	99	20	0123700000
QL 4 SAK35	99	20	0123800000
QL 10 SAK35	99	20	0338600000
VH 17/8/5 SAK35	50	20	0267000000
BFSC M4X30	50	20	0267100000
SS M4 D 128-A 4	100	20	0136400000

Type	Current [A]	Qty.	Order No.
QL 2 SAK35	99	20	0123600000
QL 3 SAK35	99	20	0123700000
QL 4 SAK35	99	20	0123800000
QL 10 SAK35	99	20	0338600000
VH 17/8/5 SAK35	50	20	0267000000
BFSC M4X30	50	20	0267100000
SS M4 D 128-A 4	100	20	0136400000

Cross-connection saddle	
	Cross-connection saddle
	Connecting sleeve
	Fixing screw

Type	Current [A]	Qty.	Order No.
VL 2 SAK35	50	20	0124000000
VH 24.5/8/5 SAK35	50	20	0298700000
BFSC M4X35	50	20	0298900000

Type	Current [A]	Qty.	Order No.
VL 2 SAK35	50	20	0124000000
VH 24.5/8/5 SAK35	50	20	0298700000
BFSC M4X35	50	20	0298900000

Socket / Test plug	
	Socket
	Test plug

Type	Current [A]	Qty.	Order No.
STB 16/D7/4/M4 SAK35	50	20	0140200000
PS 4 F.STB 4	20	20	0299600000

Type	Current [A]	Qty.	Order No.
STB 16/D7/4/M4 SAK35	50	20	0140200000
PS 4 F.STB 4	20	20	0299600000

End plate	
	yellow
	blue

Type	Width [mm]	Qty.	Order No.
AP SAK35 KRG	3	10	0303620000
AP SAK35 KRG/BL	3	10	0303670000

Type	Width [mm]	Qty.	Order No.
AP SAK35 KRG	3	10	0303620000
AP SAK35 KRG/BL	3	10	0303670000

Partition / Partition disc	
	yellow
	blue
	Partition disc

Type	Width [mm]	Qty.	Order No.
TW SAK35 KRG	3	20	0304320000

Type	Width [mm]	Qty.	Order No.
TW SAK35 KRG	3	20	0304320000

Cover / fixing screw (plastic)	
	Cover
	Fixing screw (plastic)

Type	Current [A]	Qty.	Order No.
AD 4 SAK35	50	20	0178700000
BFSC M4X32 PA/RT	100	20	0129100000

Type	Current [A]	Qty.	Order No.
AD 4 SAK35	50	20	0178700000
BFSC M4X32 PA/RT	100	20	0129100000

Marking systems

Type	Qty.	Order No.
DEK 5		

Type	Qty.	Order No.
DEK 5		

Detailed information on all versions in chapter accessories.

Modular feed-through terminal

SAK 35 N

35 mm²

SAK 70

70 mm²

SAK 95

95 mm²

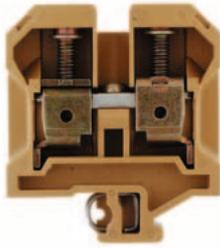

16 x 58 x 67.5
125 / 50
2.5 ... 50

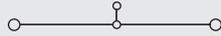

22 x 75 x 79.5
192 / 70
16 ... 70

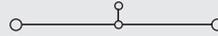

28 x 83.5 x 100.5
232 / 120
16 ... 120

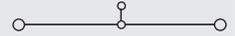

IEC 60947-7-1

IEC	UL	CSA	EN 50019
1000	600	600	
125	100	120	
35	AWG 12...2	AWG 12...2	
8 / 3			
B8 / 5VA			



Rated connection	Additional connection
2.5...16 / 4...50	
2.5...35 / 1.5...35	
4.0...5.0 (M 6)	
18 / 6.5 x 1.2	

Installation of the QL side by side use a TW/AP.

IEC 60947-7-1

IEC	UL	CSA	EN 50019
1000	600	600	
192	145	150	
70	AWG 4...2/0	AWG 4...2/0	
8 / 3			
B11 / 5VA			



Rated connection	Additional connection
16...16 / 16...70	
16...70 / 16...35	
6.0...12 (M 8)	
24 / S6 (DIN 6911)	

Tightening torque 12 Nm for H07V-R70 wire.

IEC 60947-7-1

IEC	UL	CSA	EN 50019
1000	600	600	
232	190	260	
95	AWG 6...3/0	AWG 6...3/0	
8 / 3			
B13 / 5VA			



Rated connection	Additional connection
16...16 / 16...120	
16...95 / 10...35	
16...20 (M 10)	
30 / S8 (DIN 6911)	

Type	Qty.	Order No.
SAK 35N KRG	20	0550620000

Type	Qty.	Order No.
SAK 70 KRG	10	0340820000
SAK 70 KRG/BL	10	0340870000

Type	Qty.	Order No.
SAK 95 KRG	10	0550520000

Type	Current [A]	Qty.	Order No.
QL 2 SAK35N	99	50	0564900000
QL 3 SAK35N	99	50	0565000000
QL 4 SAK35N	99	50	0565100000
QL 10 SAK35N	99	20	0565200000
VH 17/8/5 SAK35	50	20	0267000000
BFSC M4X30	50	20	0267100000
SS M4 D 128-A 4	100	20	0136400000

Type	Current [A]	Qty.	Order No.
QL 2 SAK70	192	20	0345300000
QL 3 SAK70	192	5	0167000000
VH 30.5/11/5.5 SAK70	20	20	0345500000
BFSC M5X45	20	20	0345600000
SS M5 D 128-A 5	50	20	0346100000

Type	Current [A]	Qty.	Order No.
QL 2 SAKG28	10	50	0551200000
QL 3 SAKG28	5	5	0407600000
QL 4 SAKG28	5	5	0407700000
VH 35/11/5.5 SAK95	10	20	0551100000
KISC M5X50/26 SAK95	20	20	0630200000

Type	Current [A]	Qty.	Order No.
STB 16/D7/4/M4 SAK35	50	50	0140200000
PS 4 F.STB 4	20	20	0299600000
Width [mm]			
AP SAK35 KRG	3	10	0303620000
AP SAK35 KRG/BL	3	10	0303670000
Width [mm]			
TW SAK35 KRG	3	20	0304320000

Type	Current [A]	Qty.	Order No.
STB 16/D7/4/M5 SAK70	50	50	0385400000
PS 4 F.STB 4	20	20	0299600000
Width [mm]			
AP 70 SAK70 KRG	4	10	0340920000
Width [mm]			

Type	Current [A]	Qty.	Order No.
STB 16/D7/4/M5 SAK70	50	50	0385400000
PS 4 F.STB 4	20	20	0299600000
Width [mm]			
AP SAK95 KRG	3	10	0550920000
Width [mm]			

AD 4 SAK35N	50	20	0576700000
BFSC M4X32 PA/RT	100	20	0129100000
DEK 5			

AD 3 SAK70	10	20	0344300000
BFSC M5X45 PA/NA	50	20	0344400000
DEK 5			

BFSC M5X45 PA/NA	50	20	0344400000
DEK 5			

Modular 2-tier terminals

TS 32 / PA

DK 4

4 mm²

DK 4 Q

4 mm²

TS 32 / PA

B

When using ATEX certified components in hazardous area applications the installation instructions and the rated data for accessories in the technical appendix must be considered.

Width/Length/Height with TS32	mm
Max. current / max. cond. cross-section	A/mm ²
Max. clamping range	mm ²

6 x 54	
41 / 6	
0.13 ... 6	

6 x 54 x 59.5	
41 / 6	
0.13 ... 6	

Technical data

Rated data	
Rated voltage	V
Rated current	A
Rated cross-section	mm ²
Rated impulse voltage / Pollution severity	kV/-
Plug gauge IEC 60-947-1 / flammability class acc. UL 94	
Approvals	

IEC 60947-7-1 EEx e II II 2 G D

IEC	UL	CSA	EN 50019
500	300	300	275
32	27	10	28
4	AWG 22...12	AWG 26...10	4
6 / 3			
A3 / V2			

SIRA 02ATEX3316 U

IEC 60947-7-1 EEx e II II 2 G D

IEC	UL	CSA	EN 50019
500	300	300	275
32	27	10	28
4	AWG 22...12	AWG 26...10	4
6 / 3			
A3 / V2			

SIRA 02ATEX3316 U

Clampable conductors (H05V/H07V)	
Solid / stranded	mm ²
Flexible / flexible w. wire end ferrule	mm ²
Tightening torque range (clamping screw)	Nm
Stripping length / blade size	mm / -

Rated connection	Additional connection
0.5...6 / 0.5...4	
0.5...4 / 0.5...2.5	
0.6...0.8 (M 3)	
9 / 3.5 x 0.6	

Rated connection	Additional connection
0.5...6 / 0.5...4	
0.5...4 / 0.5...2.5	
0.6...0.8 (M 3)	
9 / 3.5 x 0.6	

2 clampable conductors of equal cross-section	
Solid / stranded	mm ²
Flexible / flexible w. wire end ferrule	mm ²

0.5...1.5	
0.5...1.5 / 0.5...1.5	

0.5...1.5	
0.5...1.5 / 0.5...1.5	

Information

Order data

Version	
	beige
	blue

Type	Qty.	Order No.
DK 4	100	0355460000
DK 4 BL	100	0355480000

Type	Qty.	Order No.
DK 4Q/32	100	0590060000
DK 4Q/32 BL	100	0590080000

Information

Accessories

Cross-connection, screwable	
	2-pole
	3-pole
	4-pole
	10-pole
	Connecting sleeve
	Fixing screw
	Fuse cartridges

Type	Current [A]	Qty.	Order No.
Q 2 AKZ4	32	50	0336400000
Q 3 AKZ4	32	50	0336500000
Q 4 AKZ4	32	50	0336600000
Q 10 AKZ4	32	20	0368600000

Type	Current [A]	Qty.	Order No.
Q 2 AKZ4	32	50	0336400000
Q 3 AKZ4	32	50	0336500000
Q 4 AKZ4	32	50	0336600000
Q 10 AKZ4	32	20	0368600000

Cross-connection saddle	
	Cross-connection saddle
	Connecting sleeve
	Fixing screw

Cross-connection saddle	
	Cross-connection saddle
	Connecting sleeve
	Fixing screw

Socket / Test plug	
	Socket
	Test plug

Type	Qty.	Order No.
STB 8.5/D4/2.3/M2.5 AKZ	50	0215700000
PS 2.3 RT	20	0180400000

Type	Qty.	Order No.
STB 8.5/D4/2.3/M2.5 AKZ	50	0215700000
PS 2.3 RT	20	0180400000

End plate	
	beige
	blue

Type	Width [mm]	Qty.	Order No.
AP DK4Q	1.5	20	1397160000
AP DK4Q BL	1.5	20	1397180000

Type	Width [mm]	Qty.	Order No.
AP DK4Q	1.5	20	1397160000
AP DK4Q BL	1.5	20	1397180000

Partition / Partition disc	
	beige
	blue
	Partition disc

Type	Width [mm]	Qty.	Order No.
WTW EN	3	20	1058800000
TSCH 6 DKI S4	5	100	0190260000

Type	Width [mm]	Qty.	Order No.
WTW EN	3	20	1058800000
TSCH 6 DKI S4	5	100	0190260000

Cover / fixing screw (plastic)	
	Cover
	Fixing screw (plastic)

Cover / fixing screw (plastic)	
	Cover
	Fixing screw (plastic)

Marking systems

Detailed information on all versions in chapter accessories.

Marking systems	

Modular 2-tier terminals

DK 4 QV

4 mm²

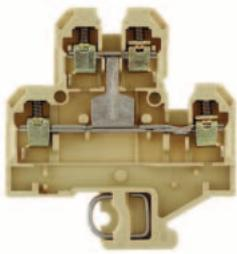

6 x 54 x 59.5

41 / 6

0.13 ... 6

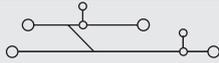

IEC 60947-7-1

EEx e II



II 2 G D

IEC	UL	CSA	EN 50019
500	300	300	275
32	27	10	28
4	AWG 22...12	AWG 26...12	4
6 / 3			
A3 / V2			



SIRA 02ATEX3316 U

Rated connection	Additional connection
0.5...6 / 0.5...4	
0.5...4 / 0.5...2,5	
0.6...0.8 (M 3)	
8 / 3.5 x 0.6	

0.5...1.5
0.5...1.5 / 0.5...1.5

Type	Qty.	Order No.
DK 4QV/32	100	0590260000
DK 4QV/32 BL	100	0590280000

Type	Current [A]	Qty.	Order No.
Q 2 AKZ4	32	50	0336400000
Q 3 AKZ4	32	50	0336500000
Q 4 AKZ4	32	50	0336600000
Q 10 AKZ4	32	20	0368600000

STB 8.5/D4/2.3/M2.5 AKZ	50	0215700000
PS 2.3 RT	20	0180400000

Width [mm]

AP DK4Q	1.5	20	1397160000
AP DK4Q BL	1.5	20	1397180000

Width [mm]

WTW EN	3	20	1058800000
--------	---	----	------------

TSCH 6 DKI S4	5	100	0190260000
---------------	---	-----	------------

AD 4 AKZ4	50	0303400000
-----------	----	------------

BFSC M2.5X18 PA/RT	100	0303300000
--------------------	-----	------------

Modular PE terminals

TS 32 / PA

EK 2.5N

2.5 mm²

EK 4

4 mm²

TS 32 / PA

B

When using ATEX certified components in hazardous area applications the installation instructions and the rated data for accessories in the technical appendix must be considered.

Width/Length/Height with TS32	mm
Max. current / max. cond. cross-section	A/mm ²
Max. clamping range	mm ²

6 x 36.5 x 46.5
/ 4
0.33 ... 4

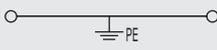

8 x 40 x 51.5
/ 6
0.33 ... 6

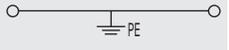

Technical data

Rated data	
Rated cross-section	mm ²
Rated voltage for adjacent terminal	V
Rated impulse voltage / Pollution severity	kV
Short-duration withstand current	A
Pollution severity	
Plug gauge IEC 60-947-1 / flammability class acc. UL 94	
Approvals	

IEC 60947-7-2 EEx e II  II 2 G D

IEC	UL	CSA	EN 50019
2.5	AWG 22... 12	AWG 26... 10	2.5
800			
8			
	300 A (2.5 mm ²)		
	3		
	A3 / V2		

IEC 60947-7-2 EEx e II  II 2 G D

IEC	UL	CSA	EN 50019
4	AWG 22... 12	AWG 26... 10	4
800			
8			
	480 A (4 mm ²)		
	3		
	A4 / V2		

Clampable conductors (H05V/H07V)	
Solid / stranded	mm ²
Flexible / flexible w. wire end ferrule	mm ²
Tightening torque range (clamping screw)	Nm
Tightening torque range (fixing screw)	Nm
Stripping length / blade size	mm / -

Rated connection	Additional connection
0.5...4 / 0.5...2.5	
0.5...4 / 0.5...2.5	
0.4...0.8 (M 2.5)	
0.5...0.8 (M 3)	
10 / 3.5 x 0.6	

Rated connection	Additional connection
0.5...6 / 0.5...4	
0.5...4 / 0.5...4	
0.5...1.0 (M 3)	
0.5...1.0 (M 3)	
12 / 3.5 x 0.6	

2 clampable conductors of equal cross-section	
Solid / stranded	mm ²
Flexible / flexible w. wire end ferrule	mm ²

Information	

Information	

Order data

Version
green/yellow

Type	Qty.	Order No.
EK 2.5N	100	0474360000

Type	Qty.	Order No.
EK 4	100	0354560000

Information

Information

Accessories

Rail support	

Type	Qty.	Order No.
SH 2	10	0494920000

Type	Qty.	Order No.
SH 2	10	0494920000

Marking systems	

Type	Qty.	Order No.
DEK 6		

Type	Qty.	Order No.
DEK 6,5		

For detailed information on other accessories and applications see "Accessories"	

For detailed information on other accessories and applications see "Accessories"	

Modular PE terminals

EK 10

10 mm²



10 x 40 x 51.5
/ 10
0.5 ... 10

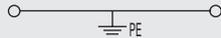

IEC 60947-7-2

EEx e II II 2 G D

IEC	UL	CSA	EN 50019
10	AWG 14...6	AWG 14...6	10
800			
8			
	720 A (6 mm ²)		
	3		
	B6 / V2		



KEMA 97ATEX1798 U

Rated connection	Additional connection
0.5...10 / 1.5...6	
0.5...10 / 0.5...10	
1.2...2.4 (M4)	
0.5...1.0 (M3)	
12 / 5.5 x 1.0	

Type	Qty.	Order No.
EK 10	100	0354660000

Type	Qty.	Order No.
SH 2	10	0494920000

DEK 5

EK 16

16 mm²



12 x 50 x 57.5
/ 16
1.5 ... 16

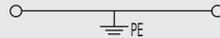

IEC 60947-7-2

IEC	UL	CSA	EN 50019
16	AWG 12...4	AWG 10...4	
800			
8			
	1920 A (16 mm ²)		
	3		
	B6 / V2		



Rated connection	Additional connection
2.5...16 / 2.5...16	
2.5...16 / 4...16	
1.2...2.4 (M4)	
0.8...1.6 (M3.5)	
16 / 5.5 x 1.0	

Type	Qty.	Order No.
EK 16	50	0374660000

Type	Qty.	Order No.
SH 2	10	0494920000

DEK 5

EK 35

35 mm²



16 x 58 x 67.5
/ 50
3.31 ... 50

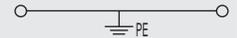

IEC 60947-7-2

EEx e II II 2 G D

IEC	UL	CSA	EN 50019
35	AWG 10...2	AWG 10...2	35
800			
8			
	4200 A (35 mm ²)		
	3		
	B9 / V2		



KEMA 97ATEX1798 U

Rated connection	Additional connection
6...16 / 16...50	
10...35 / 10...35	
4.0...6.0 (M6)	
0.8...1.6 (M3.5)	
20 / 6.5 x 1.0	

Type	Qty.	Order No.
EK 35	20	0354760000

Type	Qty.	Order No.
SH 2	10	0494920000

DEK 5

For application with a 50 mm² wire use a TS 35/15 Cu rail.

TS 32 / PA

B

Modular PE terminals

TS 32

EK 2

10 mm²

SAKE 35

35 mm²

TS 32

B

When using ATEX certified components in hazardous area applications the installation instructions and the rated data for accessories in the technical appendix must be considered.

Width/Length/Height with TS32	mm
Max. current / max. cond. cross-section	A/mm ²
Max. clamping range	mm ²

10.2 x 52 x 38	
/ 10	
1.31 ... 10	

14 x 46 x 39	
/ 35	
3.31 ... 35	



Technical data

Rated data	
Rated cross-section	mm ²
Rated voltage for adjacent terminal	V
Rated impulse voltage / Pollution severity	kV
Short-duration withstand current	A
Pollution severity	
Plug gauge IEC 60-947-1 / flammability class acc. UL 94	
Approvals	

IEC 60947-7-2

IEC	UL	CSA	EN 50019
10	AWG 16... 8	AWG 16... 8	
1200 A (10 mm ²)			
B6			

IEC 60947-7-2

IEC	UL	CSA	EN 50019
35	AWG 8... 2	AWG 8... 2	
4200 A (35 mm ²)			
B8			

Clampable conductors (H05V/H07V)	
Solid / stranded	mm ²
Flexible / flexible w. wire end ferrule	mm ²
Tightening torque range (clamping screw)	Nm
Tightening torque range (fixing screw)	Nm
Stripping length / blade size	mm / -

Rated connection	Additional connection
...10 / 1.5...10	
...10 / 1.5...10	
1.2...2.4 (M 4)	
2.0...4.0 (M 5)	
14 / 5.5 x 1.0	

Rated connection	Additional connection
...35 / 6...35	
...16 / 10...35	
4.0...5.0 (M 6)	
2.0...4.0 (M 5)	
16 / 6.5 x 1.2	

2 clampable conductors of equal cross-section	
Solid / stranded	mm ²
Flexible / flexible w. wire end ferrule	mm ²

Information

Order data

Version

Type	Qty.	Order No.
EK 2	20	0323100000

Type	Qty.	Order No.
SAKE 35	20	0144400000

Information

Accessories

--

Rail support

Type	Qty.	Order No.
SH 2	10	0494920000

Type	Qty.	Order No.
SH 2	10	0494920000

Marking systems

For detailed information on other accessories and applications see "Accessories"

Modular PE terminals

SAKE 70

70 mm²

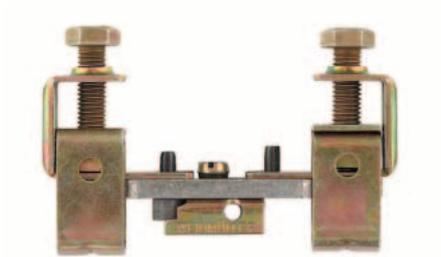

18 x 94 x 59.5

/ 70

10 ... 70

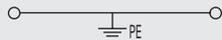

IEC 60947-7-2

IEC	UL	CSA	EN 50019
70	AWG 6... 0	AWG 6... 0	

B10



Rated connection	Additional connection
...70 / 10...70	
...70 / 10...70	
6.0...12 (M 8)	
2.0...4.0 (M 5)	
25	

A copper TS 32 must be used when connecting conductors of 50 mm² or over.

Type	Qty.	Order No.
SAKE 70/32	10	0213200000

Type	Qty.	Order No.
SH 2	10	0494920000

A copper TS 32 rail must be used for connecting conductors >= 50 mm².

Disconnect terminals

TS 32 / PA

SAKR

4 mm²

SAKR StB

4 mm²

TS 32 / PA

B

When using ATEX certified components in hazardous area applications the installation instructions and the rated data for accessories in the technical appendix must be considered.

Width/Length/Height with TS32	mm
Max. current / max. cond. cross-section	A/mm ²
Max. clamping range	mm ²

6.5 x 42 x 40.5	
10 / 4	
0.13 ... 4	

6.5 x 42 x 40.5	
10 / 4	
0.13 ... 4	



Technical data

Rated data	
Rated voltage	V
Rated current	A
Rated cross-section	mm ²
Rated impulse voltage / Pollution severity	kV/-
Plug gauge IEC 60-947-1 / flammability class acc. UL 94	
Approvals	
Clampable conductors (H05V/H07V)	
Solid / stranded	mm ²
Flexible / flexible w. wire end ferrule	mm ²
Tightening torque range (clamping screw)	Nm
Stripping length / blade size	mm / -
2 clampable conductors of equal cross-section	
Solid / stranded	mm ²
Flexible / flexible w. wire end ferrule	mm ²
Information	

IEC 60947-7-1 / VDE 0100-537			
IEC	UL	CSA	EN 50019
400	300	300	
10	10	10	
4	AWG 26...12	AWG 26...12	
		6 / 3	
		A3 / V2	
UL			
Rated connection		Additional connection	
0.5...4 / 1.5...4			
0.5...4 / 0.5...2.5			
0.5...1.0 (M3)			
8 / 3.5 x 0.6			
Tightening torque for the test sockets 0.5 ... 0.7 Nm			

IEC 60947-7-1 / VDE 0100-537			
IEC	UL	CSA	EN 50019
400	300	300	
10	10	10	
4	AWG 26...12	AWG 26...12	
		6 / 3	
		A3 / V2	
UL			
Rated connection		Additional connection	
0.5...4 / 1.5...4			
0.5...4 / 0.5...2.5			
0.5...1.0 (M3)			
8 / 3.5 x 0.6			
Tightening torque for the test sockets 0.5 ... 0.7 Nm			

Order data

Version	
	beige
	blue
Information	

Type	Qty.	Order No.
SAKR	100	0412160000
SAKR BL	100	0412180000

Type	Qty.	Order No.
SAKR 2STB	100	0412260000
SAKR 2STB BL	100	0412280000

Accessories

Cross-connection, screwable	
	2-pole
	3-pole
	4-pole
	10-pole
	Connecting sleeve
	Fixing screw
	Fuse cartridges
Cross-connection saddle	
	Cross-connection saddle
	Connecting sleeve
	Fixing screw
Socket / Test plug	
	Socket
	Test plug
End plate	
	beige
	blue
Partition / Partition disc	
	beige
	for tropical applications / blue
	Partition disc
Cover / fixing screw (plastic)	
	Cover
	Fixing screw (plastic)
Marking systems	
	DEK 6,5
Detailed information on all versions in chapter accessories.	

Type	Current [A]	Qty.	Order No.
QB 2 WI RA6 IS	27	50	0482700000
QB 3 WI RA6 IS	27	50	0482800000
QB 4 WI RA6 IS	27	50	0482900000
Width [mm]			
AP SAKR BE	1.5	20	0211360000
AP SAKR BL	1.5	20	0211380000
Width [mm]			
TW SAK2.5 HP/TF/GE/1	1	20	0297100000
QB 25 blank, see chapter accessories. To use twin ferrules ZH 0,5 to ZH 1,5 is possible.			

Type	Current [A]	Qty.	Order No.
QB 2 WI RA6 IS	27	50	0482700000
QB 3 WI RA6 IS	27	50	0482800000
QB 4 WI RA6 IS	27	50	0482900000
Width [mm]			
AP SAKR BE	1.5	20	0211360000
AP SAKR BL	1.5	20	0211380000
Width [mm]			
TW SAK2.5 HP/TF/GE/1	1	20	0297100000
QB 25 blank, see chapter accessories. To use twin ferrules ZH 0,5 to ZH 1,5 is possible.			

Disconnect terminals

SAKR-D

4 mm²

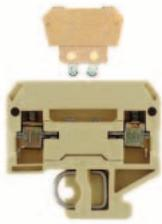

6.5 x 42 x 40.5
10 / 4
0.13 ... 4



IEC 60947-7-1 / VDE 0100-537

IEC	UL	CSA	EN 50019
250	300	300	
10	10	10	
4	AWG 26...12	AWG 22...12	
	6 / 3		
	A3 / V2		



Rated connection	Additional connection
0.5...4 / 1.5...4	
0.5...4 / 0.5...2.5	
0.5...1.0 (M 3)	
8 / 3.5 x 0.6	

Tightening torque for the test sockets 0.5 ... 0.7 Nm

Type	Qty.	Order No.
SAKR D 2STB2.3	50	0413160000

Type	Current [A]	Qty.	Order No.
QB 2 WI RA6 IS	27	50	0482700000
QB 3 WI RA6 IS	27	50	0482800000
QB 4 WI RA6 IS	27	50	0482900000

STB 6/D3.7/2.3/M3 SAKR	100	0379400000	
PS 2.3 RT	20	0180400000	
Width [mm]			
AP SAKR BE	1.5	20	0211360000
AP SAKR BL	1.5	20	0211380000
Width [mm]			
TW SAK2.5	2.5	20	0302860000
TW SAK2.5 BL	1.5	20	0302880000

DEK 6,5

DKT 4

4 mm²

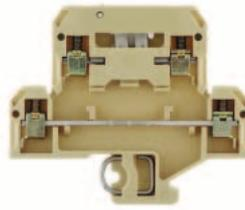

6 x 65 x 56.5
10 / 4
0.13 ... 4

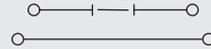

IEC 60947-7-1 / VDE 0100-537

IEC	UL	CSA	EN 50019
400	300	300	
10	10	10	
4	AWG 22...12	AWG 26...12	
	6 / 3		
	A3 / V2		



Rated connection	Additional connection
0.5...4 / 1.5...4	
0.5...4 / 0.5...2.5	
0.5...1.0 (M 3)	
9 / 3.5 x 0.6	

Type	Qty.	Order No.
DKT 4	100	0687360000

Type	Current [A]	Qty.	Order No.
QB 2 WI RA6 IS	27	50	0482700000
QB 3 WI RA6 IS	27	50	0482800000
QB 4 WI RA6 IS	27	50	0482900000

PS 2.3 RT	20	0180400000	
Width [mm]			
AP DKT4 PA	1.5	20	0687560000
Width [mm]			
TW SAKS2 HP/DBR/2	2	20	0607000000

DEK 6

DKT 4 V

4 mm²

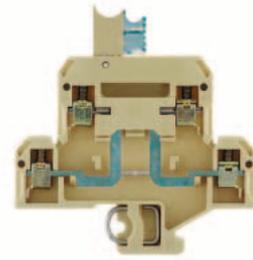

6 x 65 x 56.5
10 / 4
0.13 ... 4

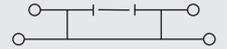

IEC 60947-7-1 / VDE 0100-537

IEC	UL	CSA	EN 50019
400			
10			
4			
	6 / 3		
	A3 / V2		

Rated connection	Additional connection
0.5...4 / 1.5...4	
0.5...4 / 0.5...2.5	
0.5...1.0 (M 3)	
9 / 3.5 x 0.6	

Type	Qty.	Order No.
DKT 4V 2STB	50	1304860000

Type	Current [A]	Qty.	Order No.
QB 2 WI RA6 IS	27	50	0482700000
QB 3 WI RA6 IS	27	50	0482800000
QB 4 WI RA6 IS	27	50	0482900000

PS 2.3 RT	20	0180400000	
Width [mm]			
AP DKT4 PA	1.5	20	0687560000
Width [mm]			
TW SAKS2 HP/DBR/2	2	20	0607000000

DEK 6

Disconnect terminals

TS 32 / KRG

SAKR

4 mm²

SAKR with socket

4 mm²

TS 32 / KRG

B

When using ATEX certified components in hazardous area applications the installation instructions and the rated data for accessories in the technical appendix must be considered.

Width/Length/Height with TS32	mm
Max. current / max. cond. cross-section	A/mm ²
Max. clamping range	mm ²

6.5 x 42 x 40.5	
10 / 4	
0.13 ... 4	

6.5 x 42 x 40.5	
10 / 4	
0.13 ... 4	



Technical data

Rated data	
Rated voltage	V
Rated current	A
Rated cross-section	mm ²
Rated impulse voltage / Pollution severity	kV/-
Plug gauge IEC 60-947-1 / flammability class acc. UL 94	
Approvals	
Clampable conductors (H05V/H07V)	
Solid / stranded	mm ²
Flexible / flexible w. wire end ferrule	mm ²
Tightening torque range (clamping screw)	Nm
Stripping length / blade size	mm / -
2 clampable conductors of equal cross-section	
Solid / stranded	mm ²
Flexible / flexible w. wire end ferrule	mm ²
Information	

IEC 60947-7-1 / VDE 0100-537			
IEC	UL	CSA	EN 50019
400	300	300	
10	10	10	
4	AWG 26...12	AWG 26...12	
		6 / 3	
		A3 / 5VA	
UL			
Rated connection	Additional connection		
0.5...4 / 1.5...4			
0.5...4 / 0.5...2.5			
0.5...1.0 (M 3)			
8 / 3.5 x 0.6			
Tightening torque for the test sockets 0.5 ... 0.7 Nm			

IEC 60947-7-1 / VDE 0100-537			
IEC	UL	CSA	EN 50019
400	300	300	
10	10	10	
4	AWG 26...12	AWG 26...12	
		6 / 3	
		A3 / 5VA	
UL			
Rated connection	Additional connection		
0.5...4 / 1.5...4			
0.5...4 / 0.5...2.5			
0.5...1.0 (M 3)			
8 / 3.5 x 0.6			
Tightening torque for the test sockets 0.5 ... 0.7 Nm			

Order data

Version	
	yellow
	blue
Information	

Type	Qty.	Order No.
SAKR KRG	100	0412120000

Type	Qty.	Order No.
SAKR 2STB KRG	100	0412220000

Accessories

Cross-connection, screwable	
	(Q)
	2-pole
	3-pole
	4-pole
	10-pole
	Connecting sleeve
	Fixing screw
	Fuse cartridges
Cross-connection saddle	
	Cross-connection saddle
	Connecting sleeve
	Fixing screw
Socket / Test plug	
	Socket
	Test plug
End plate	
	yellow
	blue
Partition / Partition disc	
	yellow
	blue
	Partition disc
Cover / fixing screw (plastic)	
	Cover
	Fixing screw (plastic)
Marking systems	
	DEK 6,5
Detailed information on all versions in chapter accessories.	

Type	Current [A]	Qty.	Order No.
QB 2 WI RA6 IS	27	50	0482700000
QB 3 WI RA6 IS	27	50	0482800000
QB 4 WI RA6 IS	27	50	0482900000
Width [mm]			
AP SAKR KRG	1.5	20	0211320000
Width [mm]			
TW SAK2.5 HP/TF/GE/1	1	20	0297100000
QB 25 blank, see chapter accessories. To use twin ferrules ZH 0,5 to ZH 1,5 is possible.			

Type	Current [A]	Qty.	Order No.
QB 2 WI RA6 IS	27	50	0482700000
QB 3 WI RA6 IS	27	50	0482800000
QB 4 WI RA6 IS	27	50	0482900000
Width [mm]			
AP SAKR KRG	1.5	20	0211320000
Width [mm]			
TW SAK2.5 HP/TF/GE/1	1	20	0297100000
QB 25 blank, see chapter accessories. To use twin ferrules ZH 0,5 to ZH 1,5 is possible.			

Disconnect terminals

SAKC 4

4 mm²

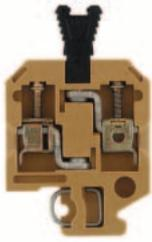

6.5 x 40 x 51.5
25 / 6
0.33 ... 6

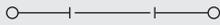

IEC 60947-7-1

IEC	UL	CSA	EN 50019
400	300	300	
25	25	25	
4	AWG 22...12	AWG 22...10	
	6 / 3		
	A4 / 5VA		



Rated connection	Additional connection
0.5...6 / 1.5...4	
0.5...4 / 0.5...4	
0.5...1.0 (M 3)	
12 / 3.5 x 0.6	

Tightening torque for the test sockets 0.5 ... 0.7 Nm

Type	Qty.	Order No.
SAKC 4 KRG	100	0340720000

SAKC4 2 STB 7 order no. 0340620000

Type	Current [A]	Qty.	Order No.
QB 2 WI RA6 IS	27	50	0482700000
QB 3 WI RA6 IS	27	50	0482800000
QB 4 WI RA6 IS	27	50	0482900000

STB 7/D4/2.3/M3 ZB/SAKC	100	0358500000
PS 2.3 RT	20	0180400000

Width [mm]			
AP SAK4-10 KRG	1.5	20	0117920000
AP SAK4-10 KRG/BL	1.5	20	0117970000

Width [mm]			
TW SAK4-10 KRG	2.5	20	0130120000
TW SAK4-10 KRG/BL	2.5	20	0130170000

DEK 6,5

Dummy plug and pull out tool see chapter accessories

SAKC 10

10 mm²

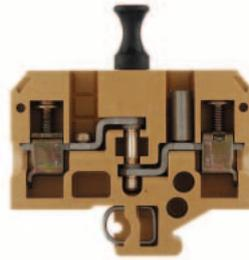

12 x 65 x 52.5
27 / 10
0.33 ... 10



IEC 60947-7-1

IEC	UL	CSA	EN 50019
400	300	600	
27	25	25	
10	AWG 22...8	AWG 20...10	
	6 / 3		
	B6 / 5VA		



Rated connection	Additional connection
0.5...10 / 1.5...4	
0.5...10 / 0.5...10	
1.2...2.4 (M 4)	
12 / 5.5 x 1.0	

Tightening torque for the test sockets 1.2 Nm. Tightening torque for 10 mm² stranded with 1.6 Nm.

Type	Qty.	Order No.
SAKC 10 2STB	50	0324120000
SAKC 10 STB/RE	50	0324020000

Type	Current [A]	Qty.	Order No.
QL 2 SAKA10	36	50	0135500000
QL 3 SAKA10	36	50	0135600000
QL 4 SAKA10	36	50	0135700000
QL 10 SAKA10	36	20	0338500000
VH 13.6/7/4.2 SAKA10	50	50	0299700000
BFSC M4X20	100	0362800000	
SS M4 D 128-A 4	100	0136400000	

VH 13.6/7/4.2 SAKA10	50	0299700000
----------------------	----	------------

STB 17/D6/4/M4 SAKC10	50	0147100000
PS 4 F.STB 4	20	0299600000

Width [mm]			
AP SAKB/C/T KRG	3	20	0146720000

Width [mm]			
TW SAKB-C-T	3	20	0242920000

DEK 6,5

Pull out force look under Accessories.

Fuse terminals

TS 32 / PA

KSKM 1

10 mm²

KSKM 2

10 mm²

5 x 20

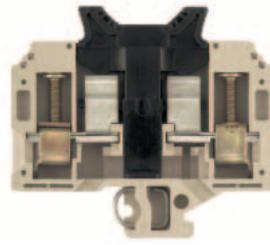

1 x 1/4

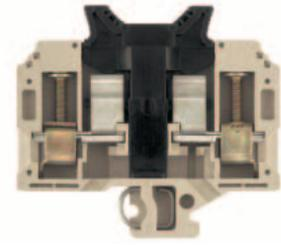

When using ATEX certified components in hazardous area applications the installation instructions and the rated data for accessories in the technical appendix must be considered.

Width/Length/Height with TS32	mm
Max. current / max. cond. cross-section	A/mm ²
Max. clamping range	mm ²

13 x 69 x 63
6.3 / 16
0.33 ... 16



13 x 69 x 63
13 / 16
0.33 ... 16



Technical data

Rated data	
Rated voltage for adjacent terminal	V
Rated current	A
Rated cross-section	mm ²
Rated impulse voltage / Pollution severity	kV/-
Plug gauge IEC 60-947-1 / flammability class acc. UL 94	
Approvals	
Clampable conductors (H05V/H07V)	
Solid / stranded	mm ²
Flexible / flexible w. wire end ferrule	mm ²
Tightening torque range (clamping screw)	Nm
Stripping length / blade size	mm / -
2 clampable conductors of equal cross-section	
Solid / stranded	mm ²
Flexible / flexible w. wire end ferrule	mm ²
Information	

IEC	UL	CSA	EN 50019
250	600		
6.3	10		
10	AWG 22... 8		
B6 / V-0			
Rated connection		Additional connection	
0.5...16			
0.5...10			
1.2...2.4 (M 4)			
12 / 5.5 x 1.0			
Information			

IEC	UL	CSA	EN 50019
250	600		
13	15		
10	AWG 22... 8		
B6 / V-0			
Rated connection			
0.5...16			
0.5...10			
1.2...2.4 (M 4)			
12 / 5.5 x 1.0			
Information			

Order data

Version	without LED
Information	

Type	Qty.	Order No.
KSKM 1/32 G20	20	9509570000
Information		

Type	Qty.	Order No.
KSKM 2/32 GZ 1X1/4	20	9509580000
Information		

Accessories

Cross-connection	Qty.	Order No.
 2-pole		
3-pole		
4-pole		
 (Q) 10-pole		
Fuse cartridges		
Rated voltage 250V		
G 20/0.1A/F		
G 20/0.2A/F		
G 20/0.25A/F		
G 20/0.5A/F		
G 20/0.63A/F		
G 20/1A/F		
G 20/1.6A/F		
G 20/2A/F		
G 20/2.5A/F		
G 20/3.15A/F		
G 20/4A/F		
G 20/5A/F		
Fuse cartridges		
Rated voltage 440V		
Contact sleeve		
SBL/1912 PLATED	10	0446100000
Marking systems		
DEK 5		
Detailed information on all versions in chapter accessories.		

Type	Current [A]	Qty.	Order No.
G 20/0.1A/F		10	0430300000
G 20/0.2A/F		10	0430400000
G 20/0.25A/F		10	0430500000
G 20/0.5A/F		10	0430600000
G 20/0.63A/F		10	0439000000
G 20/1A/F		10	0430700000
G 20/1.6A/F		10	0430800000
G 20/2A/F		10	0430900000
G 20/2.5A/F		10	0431000000
G 20/3.15A/F		10	0431100000
G 20/4A/F		10	0431200000
G 20/5A/F		10	0431300000
Information			
SBL/2111 PLATED		10	0446200000
Marking systems			
DEK 5			
Detailed information on all versions in chapter accessories.			

Type	Current [A]	Qty.	Order No.
SBL/2111 PLATED		10	0446200000
Marking systems			
DEK 5			
Detailed information on all versions in chapter accessories.			

Fuse 1 x 1/4 aren't by Weidmüller available.

Fuse terminals

KDKS 1

4 mm²

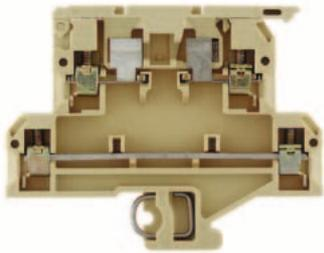

8 x 73.5 x 55.6

6.3 / 4

0.33 ... 4

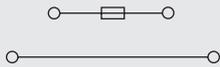

IEC 60947-7-3 / VDE 0611-6

IEC	UL	CSA	EN 50019
500	300		
6.3	10		
4	AWG 22... 12		
	6 / 3		
	A3 / V2		



Rated connection

0.5...4 / 1.5...4

0.5...4 / 0.5...4

0.6...0.8 (M 3)

8 / 3.5 x 0.6

0.5...1.5

0.5...1.5 / 0.5...1.5

Type	Qty.	Order No.
KDKS 1/32	50	9503300000

Type	Current [A]	Qty.	Order No.
QB 2 WI RAB IS		50	0461100000
QB 3 WI RAB IS		50	0461200000
QB 4 WI RAB IS		50	0461300000

G 20/0.1A/F	10	0430300000
G 20/0.2A/F	10	0430400000
G 20/0.25A/F	10	0430500000
G 20/0.5A/F	10	0430600000
G 20/1A/F	10	0430700000
G 20/1.6A/F	10	0430800000
G 20/2A/F	10	0430900000
G 20/2.5A/F	10	0431000000
G 20/3.15A/F	10	0431100000
G 20/4.00A/F	10	0431200000
G 20/5.00A/F	10	0431300000
G 20/6.30A/F	10	0431400000

DEK 8

Fuse terminals

SAKS 1 5x25

10 mm²



13 x 54 x 61
10 / 16
0.13 ... 16



IEC	UL	CSA	EN 50019
500	300	600	
10	6.3	10	
10	AWG 22... 10	AWG 26... 10	
	6 / 3		
	B6 / 5VA		



Rated connection

0.5...16 / 1.5...10
0.5...10 / 0.5...10
1.2...2.4 (M 4)
12 / 5.5 x 1.0

Type	Qty.	Order No.
SAKS 1/G25	20	0191120000

Type	Current [A]	Qty.	Order No.
QL 2 SAKS1	47	50	0191400000
QL 3 SAKS1	36	50	0191500000
QL 4 SAKS1	36	20	0191600000
QL 10 SAKS1	36	20	0338800000
Width [mm]			
AP SAKS1+3 KRG	3	20	0191320000

DEK 5

Cross connection accessories see chapter accessories

SAKS 1 5x25

10 mm²

With neon bulb

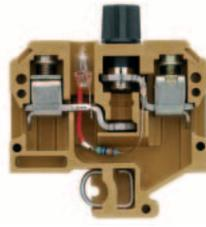

13 x 54
6.3 / 16
0.5 ... 16



IEC	UL	CSA	EN 50019
500			
6.3			
10			
	4		
	B6 / 5VA		



Rated connection

0.5...16 / 1.5...10
0.5...10 / 0.5...10
1.2...2.4 (M 4)
12 / 5.5 x 1.0

Type	Qty.	Order No.
SAKS 1/32 G25 GL 230VAC	10	0309320000

Type	Current [A]	Qty.	Order No.
Width [mm]			
AP SAKS1+3 KRG	3	20	0191320000

DEK 5

Cross connection accessories see chapter accessories

SAKS 3

10 mm²

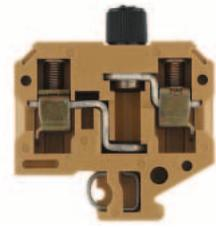

13 x 54 x 61
10 / 16
0.33 ... 16

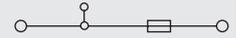

IEC	UL	CSA	EN 50019
500	300	600	
10	10	10	
10	AWG 22... 10	AWG 22... 10	
	6 / 3		
	B6 / 5VA		



Rated connection

0.5...16 / 1.5...10
0.5...10 / 0.5...10
1.2...2.4 (M 4)
12 / 5.5 x 1.0

Type	Qty.	Order No.
SAKS 3 G/5X30 500V	20	0297520000

SAKS 3 GZ/6.3X32	20	0248920000
SAKS 3 1"x1/4" with a red cap available under 0211120000.		

Type	Current [A]	Qty.	Order No.
QL 2 SAKS1	47	50	0191400000
QL 3 SAKS1	36	50	0191500000
QL 4 SAKS1	36	20	0191600000
QL 10 SAKS1	36	20	0338800000
Width [mm]			
AP SAKS1+3 KRG	3	20	0191320000

DEK 5

Cross connection accessories see chapter accessories

Fuse terminals

TS 32 / KRG

SAKS 2

10 mm²

SAKS 4

10 mm²

TS 32 / KRG

B

When using ATEX certified components in hazardous area applications the installation instructions and the rated data for accessories in the technical appendix must be considered.

Width/Length/Height with TS32	mm
Max. current / max. cond. cross-section	A/mm ²
Max. clamping range	mm ²

27.6 x 80 x 75
10 / 16
0.33 ... 16

24 x 75 x 66
16 / 16
0.33 ... 16

Technical data

Rated data	
Rated voltage for adjacent terminal	V
Rated current	A
Rated cross-section	mm ²
Rated impulse voltage / Pollution severity	kV/-
Plug gauge IEC 60-947-1 / flammability class acc. UL 94 Approvals	

Clamped conductor (H05V/H07V)	
Solid / stranded	mm ²
Flexible / flexible w. wire end ferrule	mm ²
Tightening torque range (clamping screw)	Nm
Stripping length / blade size	mm / -

2 clampable conductors of equal cross-section	
Solid / stranded	mm ²
Flexible / flexible w. wire end ferrule	mm ²

Information

IEC 60947-7-3 / VDE 0611-6

IEC	UL	CSA	EN 50019
500		600	
10		25	
10		AWG 22... 8	
		6 / 3	
		B6 / 5VA	



Rated connection	Additional connection
0.5...16 / 0.5...10	
0.5...10 / 0.5...10	
1.2...2.4 (M 4)	
12 / 5.5 x 1.0	

For short-circuit use up to 25A.

IEC 60947-7-3 / VDE 0611-6

IEC	UL	CSA	EN 50019
400	600	600	
16	30	30	
10	AWG 22... 8	AWG 22... 8	
		6 / 3	
		B6 / 5VA	



Rated connection
0.5...16 / 1.5...10
0.5...10 / 0.5...10
1.2...2.4 (M 4)
14 / 5.5 x 1.0

Tightening torque 1.6 Nm from 10 mm² stranded wire.

Order data

Version
without LED

Information

Type	Qty.	Order No.
SAKS 2	20	0206820000

Type	Qty.	Order No.
SAKS 4	20	0321320000

Accessories

Cross-connection	
	2-pole
	3-pole
	4-pole
	10-pole
	Washers
	Fixing screw

Screw cap	
	SK
	SK

Gauge pieces	

Fuse	
Rated voltage 500V	

Fuse	
Rated voltage 400V	

Marking systems

For detailed information on other accessories and applications see "Accessories"

Type	Current [A]	Qty.	Order No.
QL 2 SAKS2	47	20	0207800000
QL 3 SAKS2	36	20	0207900000
QL 4 SAKS2	36	20	0208000000
QL 10 SAKS2	36	20	0338900000
SS M4 D 128-A 4		100	0136400000
BFSC M4X9T		100	0103300000

Colour	
SK E16/SAKS2	black 25 0284110000

Colour	
P 16/16 GR SAKS2	grey 100 0209000000
P 16/20 BL SAKS2	blue 100 0209100000

E 16/10A RT TNDZ	25	0208500000
E 16/16A GR TNDZ	25	0208600000
E 16/20A BL TNDZ	25	0208700000
E 16/25A GE TNDZ	25	0208800000

DEK 5

Type	Current [A]	Qty.	Order No.
QL 2 SAKS4	47	20	0328000000
QL 3 SAKS4	36	20	0328100000
QL 4 SAKS4	36	20	0328200000
QL 10 SAKS4	36	20	0339000000
SS M4 D 128-A 4		100	0136400000
BFSC M4X9T		100	0103300000

Colour	
SK E14 SAKS4	black 20 0339410000

Colour	
P 14/2 D01 RS SAKS4	pink 50 0138000000
P 14/4 D01 BR SAKS4	brown 50 0138100000
P 14/10 D01 RT SAKS4	red 50 0328700000
P 14/6 D01 GN SAKS4	green 50 0328600000

E 14/10A RT	10	0328400000
E 14/16A GR	10	0328500000
E 14/4A RS	10	0137400000
E 14/4A BR	10	0137500000

DEK 5

Fuse terminals

SAKS 4 USA

10 mm²

1 1/4 x 1/4



24 x 75 x 73
30 / 16
0.5 ... 16



IEC	UL	CSA	EN 50019
400	600	600	
30	30	30	
10	AWG 20... 8	AWG 22... 8	
	6 / 3		
	B6 / 5VA		



Rated connection

0.5...16 / 1.5...10
0.5...10 / 0.5...10
1.2...2.4 (M 4)
14 / 5.5 x 1.0

Tightening torque 1.6 Nm from 10 mm² stranded wire.

Type	Qty.	Order No.
SAKS 4 USA	20	0162220000

SAKS 5

16 mm²

D 02 - fuse



28 x 80 x 66
63 / 16
1.5 ... 16

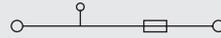

IEC 60947-7-3 / VDE 0611-6

IEC	UL	CSA	EN 50019
400	600	600	
63	40	63	
16	AWG 14... 6	AWG 14... 6	
	6 / 3		
	B7 / 5VA		



Rated connection

1.5...16 / 1.5...16
1.5...16 / 1.5...16
1.2...2.4 (M 4)
13 / 5.5 x 1.0

Tightening torque 1.6 Nm for stranded wire.

Type	Qty.	Order No.
SAKS 5 380AC	20	0359420000

Type	Current [A]	Qty.	Order No.
QL 2 SAKS4	47	20	0328000000
QL 3 SAKS4	36	20	0328100000
QL 4 SAKS4	36	20	0328200000
QL 10 SAKS4	36	20	0339000000
SS M4 D 128-A 4		100	0136400000
BFSC M4X9T		100	0103300000
Colour			
SK E14 SAKS4 USA	black	1	2012790000

Colour

DEK 5

Type	Current [A]	Qty.	Order No.
QL 2 SAKS2	47	20	0207800000
QL 3 SAKS2	36	20	0207900000
QL 4 SAKS2	36	20	0208000000
QL 10 SAKS2	36	20	0338900000
SS M4 D 128-A 4		100	0136400000
BFSC M4X9T		100	0103300000
Colour			
SK E18 SAKS5	black	20	0359310000

Colour

P 18/20 D02 BL SAKS5	blue	50	0361800000
P 18/25 D02 GE SAKS5	yellow	50	0361900000
P 18/35 D02 SW SAKS5	black	50	0362000000
P 18/50 D02 WS SAKS5	white	50	0362100000

E 18/20A BL		10	0361300000
E 18/25A GE		10	0361400000
E 18/50A WS		10	0361600000
E 18/63A KU		10	0361700000

DEK 5

Partition plate TW HP (2.0) order No. 0607000000, for TS 32 only

Fuse inserts and gauge rings for Weidmüller fuse terminals

Fuse inserts

Technical data

for terminal type

SAKS 1
SAKS 7
ASK 1
WSI 6



G fuse inserts 5 x 20 without indicator acc. to IEC 60127-2 (VDE 0820 T.2 BI 1)

Size (mm)	Rated voltage (V)	Rated current (A)	Type
5 x 20 Breaking capacity 1500 A (at 250 V, 50 Hz, cos φ 0,7)	250	0.1	(F) G 20/0.10A/F
		0.2	(F) G 20/0.20A/F
		0.25	(F) G 20/0.25A/F
		0.5	(F) G 20/0.50A/F
		0.63	(F) G 20/0.63A/F
		1.0	(F) G 20/1.00A/F
		1.6	(F) G 20/1.60A/F
		2.0	(F) G 20/2.00A/F
		2.5	(F) G 20/2.50A/F
		3.15	(F) G 20/3.15A/F
		4.0	(F) G 20/4.00A/F
		5.0	(F) G 20/5.00A/F
		6.3	(F) G 20/6.30A/F

(M) = medium-delayed action (F) = fast

Order data

Qty.	Order No.
10	0430300000
10	0430400000
10	0430500000
10	0430600000
10	0439000000
10	0430700000
10	0430800000
10	0430900000
10	0431000000
10	0431100000
10	0431200000
10	0431300000
10	0431400000

SAKS 1
SAKS 7
WSI 6



G fuse inserts 5 x 25 with indicator acc. to DIN 41576¹⁾

Size (mm)	Rated voltage (V)	Rated current (A)	Type
5 x 25 m. K.1) Breaking capacity 80 A (at 250 V, 50 Hz, cos φ = 1)	250	0.25	(M) G 25/0.25A/M
		0.5	(M) G 25/0.50A/M
		0.8	(M) G 25/0.80A/M
		1	(M) G 25/1.00A/M
		10	(M) ²⁾ G 25/10.0A/M
		2	(F) G 25/2.00A/F
		4	(F) G 25/4.00A/F
		6.3	(F) G 25/6.30A/F

(M) = medium-delayed action (F) = fast

SAKS 3³⁾
SAKS 6



Fuse inserts 1 1/4" x 1/4" without indicator acc. to BS 88

Rated current (A)	Rated voltage (V)	Rated current (A)	Type
33 kA Breaking capacity 33 kA fast	440	0.5	GZ 0.5A/F
		1	GZ 1.0A/F
		2	GZ 2.0A
		3	GZ 3.0A
		5	GZ 5.0A
		7	GZ 7.0A
		10	GZ 10.0A
		12.5	GZ 12.5A FF

(F) = fast (M) = medium-delayed action

SAKS 2



D fuse inserts E 16 with indicator acc. to DIN 49360 (dialed)

Rated current (A)	Rated voltage (V)	Rated current (A)	Type
E 10 A E 16 A E 20 A E 25 A	500	10	E 16/10A RT
		16	E 16/16A GR
		20	E 16/20A BL
		25	E 16/25A GE

(F) = fast (M) = medium-delayed action

SAKS 4⁴⁾

D fuse inserts E 14 size D 01 and E 18 size D 02 with indicator acc. to DIN 49522 (neozed)⁵⁾

Rated current (A)	Rated voltage (V)	Rated current (A)	Type
E 14/2 E 14/4 E 14/6 E 14/10 E 14/16	400	2	E 14/2A RS
		4	E 14/4A BR
		6	E 14/6A GN
		10	E 14/10A RT
		16	E 14/16A GR
E 18/20 E 18/25 E 18/35 E 18/50 E 18/63	400	20	E 18/20A BL
		25	E 18/25A GE
		35	E 18/35A SW
		50	E 18/50A WS
		63	E 18/63A KU

(F) = fast (M) = medium-delayed action

SAKS 5



Note: ¹⁾ The SIBA company also supplies 5 x 25 G fuse inserts with indicators in a shipbuilding model for 450 V AC.
²⁾ 5 x 30 (500 V AC) fuse inserts for SAKS 3 are available from the WICKMANN company
³⁾ The LINDNER company also supplies neozed fuse cartridges in an additional shipbuilding mode for 440 V AC.
⁴⁾ Fuse cartridges with the dimensions 1"x1/4" ≅ 25.4x6.35 mm and 13/32"x1/4" ≅ 10.3x38.1 mm are not included in product line.
⁵⁾ Only for SAKS 1 and SAKS 7.

Fuse inserts and gauge rings for Weidmüller fuse terminals

Gauge rings

Technical data

For terminal type

SAKS 4 and 4/35



Gauge ring type

Gauge ring type	Amp.	Colour	Typ
P 14/2	2	Pink	P 14/2D01 RS
P 14/4	4	Brown	P 14/4D01 BR
P 14/6	6	Green	P 14/6D01 GN
P 14/1	10	Red	P 14/10D01 RT

Order data

Qty.	Order No.
50	0138000000
50	0138100000
50	0328600000
50	0328700000

SAKS 5 and 5/35



P 18/20	20	Blue	P 18/20D02 BL
P 18/25	25	Yellow	P 18/25D02 GE
P 18/35	35	Black	P 18/35D02 SW
P 18/50	50	White	P 18/50D02 WS

50	0361800000
50	0361900000
50	0362000000
50	0362100000

SAKS 2 and 2/35



P 16/10	10	Red	P 16/10 RT
P 16/16	16	Grey	P 16/16 GR
P 16/20	20	Blue	P 16/20 BL

100	0208900000
100	0209000000
100	0209100000

Spring Loaded Terminal

TS 32

RSF 3

4 mm²

RSF 1

10 mm²

Material PA 6.6

Material KrG

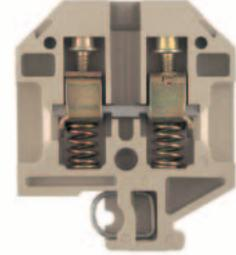
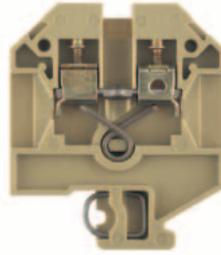

When using ATEX certified components in hazardous area applications the installation instructions and the rated data for accessories in the technical appendix must be considered.

Width/Length/Height with TS32	mm
Max. current / max. cond. cross-section	A/mm ²
Max. clamping range	mm ²

8 x 50 x 60	
32 / 4	
0.5 ... 4	

11 x 50 x 60	
57 / 10	
0.5 ... 10	

Technical data

Rated data	
Rated voltage	V
Rated current	A
Rated cross-section	mm ²
Rated impulse voltage / Pollution severity	kV/-
Plug gauge IEC 60-947-1 / flammability class acc. UL 94	
Approvals	

IEC 60947-7-1

IEC	UL	CSA	EN 50019
630	600	600	
32	20	25	
4	AWG 22...12	AWG 22...12	
		6 / 3	
		/ V2	

IEC 60947-7-1

IEC	UL	CSA	EN 50019
500		300	
57		50	
10		AWG 14...8	
		6 / 3	
		A5 / 5VA	

Clampable conductors (H05V/H07V)	
Solid / stranded	mm ²
Flexible / flexible w. wire end ferrule	mm ²
Tightening torque range (clamping screw)	Nm
Stripping length / blade size	mm / -

Rated connection		Additional connection	
0.5...4	0.5...4		
0.5...4			
0.5...1.0 (M3)			
12 / 3.5 x 0.6			

Rated connection		Additional connection	
0.5...10	0.5...10		
1.5...10			
1.2...2.4 (M4)			
15 / 5.5 x 1.0			

2 clampable conductors of equal cross-section	
Solid / stranded	mm ²
Flexible / flexible w. wire end ferrule	mm ²

Information

Information

Information

Order data

Version

Type	Qty.	Order No.
RSF 3 PA	50	0497560000

Type	Qty.	Order No.
RSF 1 KR G	50	0270320000

Accessories

Cross-connection, screwable	
	2-pole
	3-pole
	4-pole
	10-pole
Connecting sleeve	
Fixing screw	
Fuse cartridges	

Type	Current [A]	Qty.	Order No.
QL 2 SAK6N	57	50	0194300000
QL 3 SAK6N	57	50	0194400000
QL 4 SAK6N	57	50	0194500000
QL 10 SAK6N	57	20	0338300000
VH 13.5/4.9/3.3 SAK4		100	0248500000
KISC M3X20.5/10 EK4		100	0303000000
SS M3 D 128-A 3		50	0164400000

Type	Current [A]	Qty.	Order No.
QL 2 RSF1+2/SAK10ZU16		50	0267400000
QL 3 RSF1+2		50	0267500000
QL 4 RSF1+2		50	0267600000
QL 10 RSF1+2		20	0341700000
BFSC M4X6		100	0149700000
SS M3 D 128-A 3		50	0164400000

Cross-connection saddle	
Cross-connection saddle	
Connecting sleeve	
Fixing screw	

Type	Current [A]	Qty.	Order No.
VL 2 SAK6N/SAKT		50	0194700000
VH 21/5/3.5 SAK16-35		50	0309600000
BFSC M3X30		50	0296200000

Type	Current [A]	Qty.	Order No.
VL 2 RSF 1+2		50	0528400000
VH 27/5/3.5 SAK10-35		50	0309400000
BFSC M3X35		50	0309800000

Socket / Test plug	
Socket	
Test plug	

Type	Current [A]	Qty.	Order No.
STB 14/D5/2.3/M3 SAK2.5		50	0168600000
PS 2.3 RT		20	0180400000

Type	Current [A]	Qty.	Order No.
STB 14/D6/4/M3 SAK10		50	0169900000
PS 4 F.STB 4		20	0299600000

End plate	
blue	

Width [mm]	
AP RSF3	3 10 0270460000

Width [mm]	
AP RSF1 KR G	3 10 0270420000

Partition / Partition disc	
blue	
Partition disc	

Width [mm]	
TW AST1/PA HP/DBR/0.5	0.5 20 0474700000
TSCH 1	2 100 0319160000

Width [mm]	
TW AST1/PA HP/DBR/0.5	0.5 20 0474700000

Cover / fixing screw (plastic)	
Cover	
Fixing screw (plastic)	

Type	Qty.	Order No.
ADP 2/HP2 1M	36	0485300000

Type	Qty.	Order No.
ADP 2/HP2 1M	36	0485300000

Marking systems	
DEK 5	

Marking systems	
DEK 5	

Marking systems	
DEK 5	

Detailed information on all versions in chapter accessories.

Spring Loaded Terminal

RSF 2

6 mm²

Material KrG

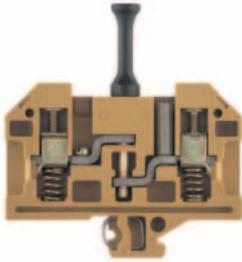

11 x 77 x 73
41 / 16
0.75 ... 16

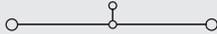

IEC 60947-7-1 / VDE 0100-537

IEC	UL	CSA	EN 50019
500		300	
41		30	
6		AWG 14...8	
	6 / 3		
	/ 5VA		

Rated connection **Additional connection**

0.75...16 / 0.75...10

1.2...2.4 (M 4)
12 / 5.5 x 1.0

RSF 3

4 mm²

Material KrG

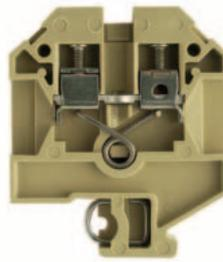

8 x 50 x 60
32 / 4
0.5 ... 4

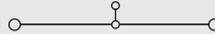

IEC 60947-7-1

IEC	UL	CSA	EN 50019
630	600	600	
32	20	25	
4	AWG 22...12	AWG 22...12	
	6 / 3		
	/ 5VA		

Rated connection **Additional connection**

0.5...4 / 0.5...4

0.5...4

0.5...1.0 (M 3)
12 / 3.5 x 0.6

Type	Qty.	Order No.
RSF 2	20	0623320000

Type	Qty.	Order No.
RSF 3	50	0497520000

Type	Current [A]	Qty.	Order No.
QL 2 RSF1+2/SAK10ZU16	50	50	0267400000
QL 3 RSF1+2	50	50	0267500000
QL 4 RSF1+2	50	50	0267600000
QL 10 RSF1+2	20	20	0341700000

BFSC M4X6	100	0149700000
-----------	-----	------------

STB 17/D6/4/M4 SAKC10	50	0147100000
-----------------------	----	------------

PS 4 F.STB 4	20	0299600000
--------------	----	------------

Width [mm]		Qty.	Order No.
AP RSF2 KRG	3	10	0301420000

Width [mm]		Qty.	Order No.

DEK 5

Type	Current [A]	Qty.	Order No.
QL 2 SAK6N	57	50	0194300000
QL 3 SAK6N	57	50	0194400000
QL 4 SAK6N	57	50	0194500000
QL 10 SAK6N	57	20	0338300000
VH 13.5/4.9/3.3 SAK4		100	0248500000
KISC M3X20.5/10 EK4		100	0303000000
SS M3 D 128-A 3		50	0164400000

VL 2 SAK6N/SAKT	50	0194700000
-----------------	----	------------

VH 21/5/3.5 SAK16-35	50	0309600000
----------------------	----	------------

BFSC M3X30	50	0296200000
------------	----	------------

STB 14/D5/2.3/M3 SAK2.5	50	0168600000
-------------------------	----	------------

PS 2.3 RT	20	0180400000
-----------	----	------------

Width [mm]		Qty.	Order No.
AP RSF3	3	10	0270460000

Width [mm]		Qty.	Order No.
TW AST1/PA HP/DBR/0.5	0.5	20	0474700000

TSCH 1	2	100	0319160000
--------	---	-----	------------

ADP 2/HP2 1M	36	0485300000
--------------	----	------------

DEK 5

Modular disconnect test terminals

TS 32 / KRG

SAKA 10

10 mm²

SAKB 10

10 mm²

TS 32 / KRG

B

When using ATEX certified components in hazardous area applications the installation instructions and the rated data for accessories in the technical appendix must be considered.

Width/Length/Height with TS32	mm
Max. current / max. cond. cross-section	A/mm ²
Max. clamping range	mm ²

12 x 82 x 55.5
47 / 10
0.5 ... 10



10 x 65 x 52.5
57 / 10
0.5 ... 10

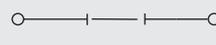

Technical data

Rated data	
Rated voltage	V
Rated current	A
Rated cross-section	mm ²
Rated impulse voltage / Pollution severity	kV/-
Plug gauge IEC 60-947-1 / flammability class acc. UL 94 Approvals	
Clampable conductors (H05V/H07V)	
Solid / stranded	mm ²
Flexible / flexible w. wire end ferrule	mm ²
Tightening torque range (clamping screw)	Nm
Tightening torque range disconnecter	Nm
Stripping length / blade size	mm / -

IEC 60947-7-1			
IEC	UL	CSA	EN 50019
500		600	
47		35	
10		AWG 18... 8	
		6 / 3	
		B6 / 5VA	

IEC 60947-7-1			
IEC	UL	CSA	EN 50019
500		600	
57		45	
10		AWG 18... 8	
		6 / 3	
		B6 / 5VA	

Information	
Tightening torque 1.6 Nm for 10 mm ² stranded wire.	

Information	
Tightening torque 1.6 Nm for 10 mm ² stranded wire.	

Information	
Tightening torque 1.6 Nm for 10 mm ² stranded wire.	

Order data

Version	
Without socket	
with open back for cross-connection	
with 1 socket	
with 2 sockets	
with 4 sockets	
Information	

Type	Qty.	Order No.
SAKA 10	25	0134120000
Information		

Type	Qty.	Order No.
SAKB 10	50	0134920000
Information		

Accessories

Cross-connection	
ZQV: pluggable cross-connection	2-pole
	3-pole
	4-pole
	10-pole / 32-pole
Connecting sleeve for cross-conn. QL	
Fixing screw for cross-conn. QL	



End plate / partition	
End plate	
Partition	
Partition disc	

Cross-connection slider	
	2-pole
	3-pole
	4-pole
Connecting sleeve for QVS	
Fixing screw for QVS	



Testing/Checking	
Test plug	
Socket	
Socket	

Other accessories	
Lockout device	
Shorting plug, 2-pole	

Marking systems	
DEK 5	

For detailed information on other accessories and applications see "Accessories"

Type	Current [A]	Qty.	Order No.
QL 2 SAKA10	47	50	0135500000
QL 3 SAKA10	36	50	0135600000
QL 4 SAKA10	36	50	0135700000
QL 10 SAKA10	36	20	0338500000
VH 23/6/4.2 SAKA10		50	0348700000
BFSC M4X30		50	0267100000

Width [mm]	
AP SAKA KRG	3 20
TW SAK2.5-35/32 KRG	3 10

Type	Current [A]	Qty.	Order No.
QL 2 SAKB10	47	100	0114100000
QL 3 SAKB10	36	50	0114300000
QL 4 SAKB10	36	50	0114500000
QL 10 SAKB10	36	20	0338400000
BFSC M4X9T		100	0103300000

Width [mm]	
AP SAKB/C/T KRG	3 20
TW SAKB-C-T	3 20

Testing/Checking	
PS 4 F.STB 4	20
STB 13.5/D6/4/M4 SAKA10	50
PS 4 F.STB 4	20
STB 16/D7/4/M4 SAK35	50

Other accessories	
DEK 5	

Marking systems	
DEK 5	

Modular disconnect test terminals

SAKT 1/LT

6 mm²

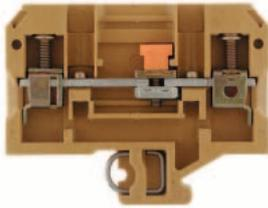

8 x 65 x 52.5
57 / 10
0.13 ... 10



IEC 60947-7-1

IEC	UL	CSA	EN 50019
400	300	300	
41	25	25	
6	AWG 26...8	AWG 26...8	
6 / 3			
A5 / 5VA			



Rated connection	Additional connection
0.5...10 / 1.5...10	
0.5...6 / 0.5...6	
0.8...1.6 (M 3.5)	

12 / 4.0 x 0.8

Tightening torque 1.6 Nm for 10 mm² stranded wire.

Type	Qty.	Order No.
SAKT 1/LT	50	0269120000
SAKT 1/LT STB14/4	50	0437920000

Type	Current [A]	Qty.	Order No.
QL 2 SAK6N	57	50	0194300000
QL 3 SAK6N	57	50	0194400000
QL 4 SAK6N	57	50	0194500000
QL 10 SAK6N	57	20	0338300000
VH 12/4.9/3.3 SAK6N		100	0249000000
KISC M3X20 SAK10 CU5		100	0377100000
Width [mm]			
AP SAKB/C/T KRG	3	20	0146720000
TW SAKB/C/T1	1.5	20	0242960000
TSCH 2	0.6	100	0353660000
QVS 2 SAKT1+2		20	0307300000
QVS 3 SAKT1+2		20	0329300000
QVS 4 SAKT1+2		20	0307400000
VH 19/6/4.2 SAKT1		50	0318000000
BS 25 O.IH SAKT1		50	0334700000
PS 4 F.STB 4		20	0299600000
STB 14/D6/4/M3 SAK10		50	0169900000
SSP 3 SAKT1		100	0531760000
QS 2/8/4		20	0270960000
DEK 6,5			

To safe the test sockets use the SDIZ-blade (see chapter Tools) or bits with pilots!

SAKT 1/DU1

6 mm²

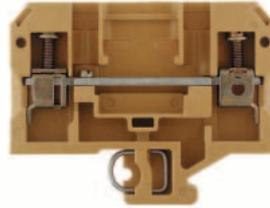

8 x 65 x 52.5
57 / 10
0.13 ... 10



IEC 60947-7-1

IEC	UL	CSA	EN 50019
400	300	300	
41	25	25	
6	AWG 26...8	AWG 26...8	
6 / 3			
A5 / 5VA			



Rated connection	Additional connection
0.5...10 / 1.5...10	
0.5...6 / 0.5...8	
0.8...1.6 (M 3.5)	

12 / 4.0 x 0.8

Tightening torque 1.6 Nm for 10 mm² stranded wire.

Type	Qty.	Order No.
SAKT 1/DU2	50	0550420000
SAKT 1/DU1	50	0195620000

Type	Current [A]	Qty.	Order No.
QL 2 SAK6N	57	50	0194300000
QL 3 SAK6N	57	50	0194400000
QL 4 SAK6N	57	50	0194500000
QL 10 SAK6N	57	20	0338300000
VH 12/4.9/3.3 SAK6N		100	0249000000
KISC M3X20 SAK10 CU5		100	0377100000
Width [mm]			
AP SAKB/C/T KRG	3	20	0146720000
TW SAKB/C/T1	1.5	20	0242960000
TSCH 2	0.6	100	0353660000
QVS 2 SAKT1+2		20	0307300000
QVS 3 SAKT1+2		20	0329300000
QVS 4 SAKT1+2		20	0307400000
VH 19/6/4.2 SAKT1		50	0318000000
BS 25 O.IH SAKT1		50	0334700000
PS 4 F.STB 4		20	0299600000
STB 14/D6/4/M3 SAK10		50	0169900000
SSP 3 SAKT1		100	0531760000
QS 2/8/4		20	0270960000
DEK 6,5			

To safe the test sockets use the SDIZ-blade (see chapter Tools) or bits with pilots!

SAKT 1/QT

6 mm²

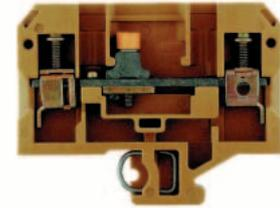

8 x 65 x 52.5
57 / 10
0.13 ... 10

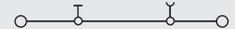

IEC 60947-7-1

IEC	UL	CSA	EN 50019
400	300	300	
41	25	25	
6	AWG 26...8	AWG 26...8	
6 / 3			
A5 / 5VA			



Rated connection	Additional connection
0.5...10 / 1.5...10	
0.5...6 / 0.5...6	
0.8...1.6 (M 3.5)	

12 / 4.0 x 0.8

Tightening torque 1.6 Nm for 10 mm² stranded wire.

Type	Qty.	Order No.
SAKT 1/QT2	50	0494820000
SAKT 1/QT1	50	0269320000

Type	Current [A]	Qty.	Order No.
QL 2 SAK6N	57	50	0194300000
QL 3 SAK6N	57	50	0194400000
QL 4 SAK6N	57	50	0194500000
QL 10 SAK6N	57	20	0338300000
VH 12/4.9/3.3 SAK6N		100	0249000000
KISC M3X20 SAK10 CU5		100	0377100000
Width [mm]			
AP SAKB/C/T KRG	3	20	0146720000
TW SAKB/C/T1	1.5	20	0242960000
TSCH 2	0.6	100	0353660000
QVS 2 SAKT1+2		20	0307300000
QVS 3 SAKT1+2		20	0329300000
QVS 4 SAKT1+2		20	0307400000
VH 19/6/4.2 SAKT1		50	0318000000
BS 25 O.IH SAKT1		50	0334700000
PS 4 F.STB 4		20	0299600000
STB 14/D6/4/M3 SAK10		50	0169900000
SSP 3 SAKT1		100	0531760000
QS 2/8/4		20	0270960000
DEK 6,5			

To safe the test sockets use the SDIZ-blade (see chapter Tools) or bits with pilots!

Modular disconnect test terminals

TS 32 / KRG

SAKT 2/LT

6 mm²

SAKT 4/LT

4 mm²

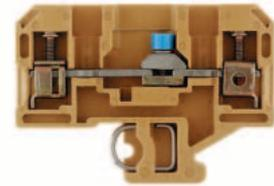
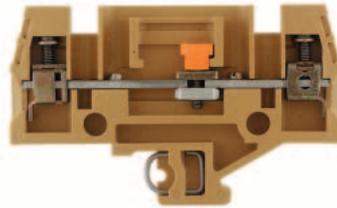

When using ATEX certified components in hazardous area applications the installation instructions and the rated data for accessories in the technical appendix must be considered.

Width/Length/Height with TS32	mm
Max. current / max. cond. cross-section	A/mm ²
Max. clamping range	mm ²

8 x 82 x 52.5
46 / 10
0.5 ... 10

8 x 57.2 x 42.5
41 / 6
0.13 ... 6

Technical data

Rated data	
Rated voltage	V
Rated current	A
Rated cross-section	mm ²
Rated impulse voltage / Pollution severity	kV/-
Plug gauge IEC 60-947-1 / flammability class acc. UL 94	
Approvals	
Clampable conductors (H05V/H07V)	
Solid / stranded	mm ²
Flexible / flexible w. wire end ferrule	mm ²
Tightening torque range (clamping screw)	Nm
Tightening torque range disconnecter	Nm
Stripping length / blade size	mm / -
Information	

IEC 60947-7-1			
IEC	UL	CSA	EN 50019
400	300	300	
41	25	25	
6	AWG 22... 8	AWG 26... 8	
		6 / 3	
		A5 / 5VA	
UL			
Rated connection		Additional connection	
0.5...10 / 1.5...6			
0.5...6 / 0.5...6			
0.8...1.6 (M 3.5)			
12 / 4.0 x 0.8			
Tightening torque 1.6 Nm for 10 mm ² stranded wire.			

IEC 60947-7-1			
IEC	UL	CSA	EN 50019
400	300	300	
32	20	20	
4	AWG 22... 12	AWG 26... 10	
		6 / 3	
		A3 / 5VA	
UL			
Rated connection		Additional connection	
0.5...6 / 1.5...4			
0.5...4 / 0.5...4			
0.4...0.7 (M 2.5)			
10 / 3.5 x 0.6			

Order data

Version	
Without socket	
with open back for cross-connection	
with 1 socket	
with 2 sockets	
with 4 sockets	
Information	

Type	Qty.	Order No.
SAKT 2/LT O.STB	50	0445420000
SAKT 2/LT STB	50	0330620000
SAKT 2/LT 4STB	50	0437720000

Type	Qty.	Order No.
SAKT 4/LT O.STB	50	0254120000
SAKT 4/LT 1STB2.0	50	0254220000
SAKT 4/LT STB2.0	50	0310320000

Accessories

Cross-connection	
ZQV: pluggable cross-connection	2-pole
	3-pole
	4-pole
	10-pole / 32-pole
Connecting sleeve for cross-conn. QL	
Fixing screw for cross-conn. QL	
End plate / partition	
End plate	
Partition	
Partition disc	
Cross-connection slider	
2-pole	
3-pole	
4-pole	
Connecting sleeve for QVS	
Fixing screw for QVS	
Testing/Checking	
Test plug	
Socket	
Socket	
Other accessories	
Lockout device	
Shorting plug, 2-pole	
Marking systems	
DEK 6,5	

Type	Current [A]	Qty.	Order No.
QL 2 SAK6N	57	50	0194300000
QL 3 SAK6N	57	50	0194400000
QL 4 SAK6N	57	50	0194500000
QL 10 SAK6N	57	20	0338300000
VH 12/4.9/3.3 SAK6N		100	0249000000
KISC M3X20 SAK10 CU5		100	0377100000
Width [mm]			
AP SAKB/C/T KRG	3	20	0146720000
TW SAKB/C/T1	1.5	20	0242960000
TSCH 2	0.6	100	0353660000
Width [mm]			
QVS 2 SAKT1+2		20	0307300000
QVS 3 SAKT1+2		20	0329300000
QVS 4 SAKT1+2		20	0307400000
VH 19/6/4.2 SAKT1		50	0318000000
BS 25 0.IH SAKT1		50	0334700000
Width [mm]			
PS 4 F.STB 4		20	0299600000
STB 14/D6/4/M3 SAK10		50	0169900000
Width [mm]			
SSP 3 SAKT1		100	0531760000
QS 2/8/4		20	0270960000
DEK 6,5			

Type	Current [A]	Qty.	Order No.
QL 2 SAK2.5	41	100	0155900000
QL 3 SAK2.5	41	100	0156000000
QL 4 SAK2.5	41	50	0156100000
QL 10 SAK2.5	41	20	0338100000
VH 8/4.9/3.3 SAK2.5		100	0266700000
KISC M3X20 SAK10 CU5		100	0377100000
Width [mm]			
TW AST1/PA HP/DBR/0.5	0.5	20	0474700000
Width [mm]			
QVS 2/4 SAKT4		20	1319260000
Width [mm]			
VH 16/5/3.5 SAK10-35		50	0309700000
BFSC M3X22 SAKT4		50	1319900000
Width [mm]			
PS 2,3 RT		20	0180400000
STB 8.5/5/2.3/M3 SAK2.5		50	0280600000
STB 8.5/D4.5/2/M3 SAKT4		50	0244600000
Width [mm]			
SSP 4 SAKT4		20	1319360000
Width [mm]			
DEK 6,5			

For detailed information on other accessories and applications see "Accessories"

To safe the test sockets use the SDIZ-blade (see chapter Tools) or bits with pilots

To safe the test sockets use the SDIZ-blade (see chapter Tools) or bits with pilots

Modular disconnect test terminals

SAKT 4/DU

4 mm²

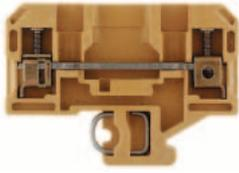

6 x 57.2 x 42.5

41 / 6

0.13 ... 6

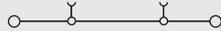

IEC 60947-7-1

IEC	UL	CSA	EN 50019
400	300	300	
32	20	20	
4	AWG 22... 12	AWG 26... 12	
	6 / 3		
	A3 / 5VA		



Rated connection	Additional connection
0.5...6 / 1.5...4	
0.5...4 / 0.5...4	
0.4...0.7 (M 2.5)	

10 / 3.5 x 0.6

Type	Qty.	Order No.
SAKT 4/DU O.STB	50	0246320000

Type	Current [A]	Qty.	Order No.
QL 2 SAK2.5	41	100	0155900000
QL 3 SAK2.5	41	100	0156000000
QL 4 SAK2.5	41	50	0156100000
QL 10 SAK2.5	41	20	0338100000
VH 12/4.9/3.3 SAK6N		100	0249000000
KISC M3X15/6 SAK2.5 CU5		100	0377200000
Width [mm]			
TW AST1/PA HP/DBR/0.5	0.5	20	0474700000
TSCH 2	0.6	100	0353660000
QVS 2/4 SAKT4		20	1319260000
VH 16/5/3.5 SAK10-35		50	0309700000
BFSC M3X22 SAKT4		50	1319900000
PS 2.3 RT		20	0180400000
STB 8.5/D4.5/2/M3 SAKT4		50	0244600000
STB 8.5/5/2.3/M3 SAK2.5		50	0280600000
SSP 4 SAKT4		20	1319360000

To safe the test sockets use the SDIZ-blade (see chapter Tools) or bits with pilots

Feed-through terminals for thermocouples

Thermocouple-terminals TS 32/PA

Busbars made from thermocouple materials according to DIN IEC 584

SAK 2.5 TC

DK 4 Q/TC

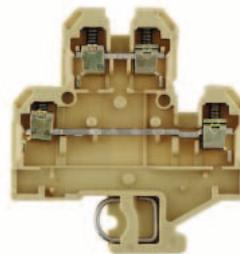

Width/length/height with TS15x5.5	mm
max. current / max. conductor	A/mm ²
max. clamping range	mm ²

6 x 36.5 x 49.5	
/ 2.5	
0.5 ... 2.5	

6 x 54 x 59.5	
/ 4	
0.5 ... 4	

Technical data

Measure/Approvals	
Width/length/height (mm)	with TS 32
Insulation stripping length/clamping screw/screwdriver blade	

6/36.5/49.5	
10 mm/M 2.5/3.5 x 0.6	

6/54/59.5	
9 mm/M 3/3.5 x 0.6	

Technical data/VDE	
Insulation stripping length/clamping screw/screwdriver blade	mm ²

2.5	
-----	--

4	
---	--

Tightening torque range	Nm
-------------------------	----

0.4...0.6	
-----------	--

0.5...1	
---------	--

Ordering data

Version	Type
NiCr	
Ni	
CuNi	
Fe	
Cu	
NiCr/Ni	K
Cu/CuNi	T
Fe/CuNi	J

	Qty.	Order No.
	100	0107260000
	100	0107160000
	100	0189860000
	100	0190060000
	100	0189960000

	Qty.	Order No.
	100	1338260000
	100	1338160000
	100	1338060000

End plate	Type
	PA

Type	Width [mm]	Qty.	Order No.
AP	1.5	20	0279560000

Type	Width [mm]	Qty.	Order No.
AP	1.5	20	1397160000

Partition	Type
	PA
	WEM
	for TS 32 HP

Type	Width [mm]	Qty.	Order No.
TW	1.5	20	0302860000

Type	Width [mm]	Qty.	Order No.
WTW EN	3.0	20	1058800000
TW HP	2.0	20	0607000000

Labelling systems	Labelling tags
	DEK 6

DEK 6	
-------	--

DEK 6	
-------	--

Detailed information on other accessories and their use can be found in the "Accessories" section.

Further versions on request.

Further versions on request.

Feed-through terminals for thermocouples

Weidmüller's **thermocouple-terminals** are specially designed for transmitting the smallest voltages in temperature measuring circuits. Special busbars ensure that no false signals occur in the terminal when temperature differences exist in the positive and negative path. This high measuring precision is necessary for, e.g. test beds, air craft engines, for complicated chemical processes, controls, etc.

I. Configuration of a temperature measuring circuit

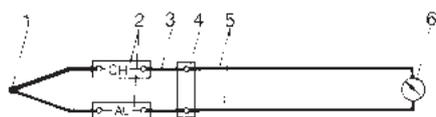

- | | |
|--------------------------|-----------------------------------|
| 1 Thermocouple (sensor) | 4 Reference point |
| 2 Thermocouple terminals | 5 Supply conductors (to and from) |
| 3 Compensation conductor | 6 Measuring device |

The thermocouple terminals displayed in this measurement circuit are used to thermoelectrically transmit thermal e.m.f. of the thermocouple to the reference point and indicating device via the thermocouple.

II. Symbols Thermocouples according to IEC 584 DIN 43710

	Terminal	Busbar material trade name
a) Type J		
Fe (positive leg)		Iron
CuNi (negative leg)		Constantan
b) Type T		
Cu (positive leg)		Copper
CuNi (negative leg)		Constantan
c) Type K		
NiCr (positive leg)		Chromel
Ni (negative leg)		Alumel

Modular terminals with screwless connections

with push-on connection
TS 32 / PA

AST 1

2.5 mm²

AST 3

2.5 mm²

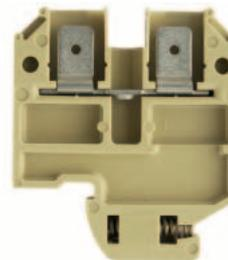

When using ATEX certified components in hazardous area applications the installation instructions and the rated data for accessories in the technical appendix must be considered.

Width/Length/Height with TS32	mm
Max. current / max. cond. cross-section	A/mm ²
Max. clamping range	mm ²

6.5 x 58 x 46	20	F6.3 F2.8	F6.3 F2.8	F6.3 F2.8	F6.3 F2.8
----------------------	-----------	-----------	-----------	-----------	-----------

6.5 x 40 x 46	20	6.3 2.8	6.3 2.8
----------------------	-----------	---------	---------

Technical data

Rated data	
Rated voltage	V
Rated current	A
Rated cross-section	mm ²
Rated impulse voltage / Pollution severity	kV/-
Plug gauge IEC 60-947-1 / flammability class acc. UL 94	
Approvals	

IEC 60947-7-1 / IEC 61210

IEC	UL	CSA	EN 50019
800	600	300	
20	13	16	
2.5			
		6 / 3	
			/ V2

IEC 60947-7-1 / IEC 61210

IEC	UL	CSA	EN 50019
800	300	300	
20	13	16	
2.5			
		6 / 3	
			/ 5VA

Clampable conductors (H05V/H07V)	
Solid / stranded	mm ²
Flexible / flexible w. wire end ferrule	mm ²
Tightening torque range (clamping screw)	Nm
Stripping length / blade size	mm / -



Rated connection	Additional connection



Rated connection	Additional connection

2 clampable conductors of equal cross-section	
Solid / stranded	mm ²
Flexible / flexible w. wire end ferrule	mm ²

Information

For tab connection use a insulated sleeve.

For tab connection use a insulated sleeve.

Order data

Version	
slotted	
Unslotted	
slotted blue	
Unslotted blue	

Type	Qty.	Order No.
AST 1 6.3/2.8	50	0478260000
AST 1 6.3	50	0266360000

Type	Qty.	Order No.
AST 3 6.3	100	0236760000

Information

Accessories

Cross-connection	
	2-pole
	3-pole
	4-pole
	10-pole

Type	Current [A]	Qty.	Order No.
Q 2 SAK4	41	50	0336700000
Q 3 SAK4	41	50	0336800000
Q 4 SAK4	41	50	0336900000
Q 10 SAK4	41	20	0368800000

Type	Current [A]	Qty.	Order No.
Q 2 SAK4	41	50	0336700000
Q 3 SAK4	41	50	0336800000
Q 4 SAK4	41	50	0336900000
Q 10 SAK4	41	20	0368800000

Plug adapter	
	2-pole
	3-pole
	4-pole
	5-polig
	8-pole

Type	Current [A]	Qty.	Order No.
STA 2.5/2		100	0165860000
STA 2.5/3		50	0165960000
STA 2.5/4		50	0190360000
STA 2.5/5		50	0166060000
STA 2.5/8		50	0166160000

Type	Current [A]	Qty.	Order No.
STA 2.5/2		100	0165860000
STA 2.5/3		50	0165960000
STA 2.5/4		50	0190360000
STA 2.5/5		50	0166060000
STA 2.5/8		50	0166160000

End plate / partition	
End plate	
Partition	
Partition disc	

Type	Current [A]	Qty.	Order No.
AP AST1+5 DB	1.5	20	0266400000
TW AST1/PA HP/DBR/0.5	0.5	20	0474700000
TSCH 1	2	100	0319160000

Type	Current [A]	Qty.	Order No.
AP SAK2.5/35 + AST3+4	1.5	20	0460560000
TW SAKS2 HP/DBR/2	2	20	0607000000
TSCH 1	2	100	0319160000

Testing/Checking	
for testing	PS
wired terminal strips	StB

Type	Current [A]	Qty.	Order No.
PS 2.3 RT		20	0180400000
STB 14/D5/2.3/M3 SAK2.5		50	0168600000

Type	Current [A]	Qty.	Order No.
PS 2.3 RT		20	0180400000
STB 14/D5/2.3/M3 SAK2.5		50	0168600000

Insulating sleeve	
	2.8
	6.3

Type	Current [A]	Qty.	Order No.
IH 2.8 DB		100	0386060000
IH 6.3 WEM GE		100	0386260000

Type	Current [A]	Qty.	Order No.
IH 2.8 DB		100	0386060000
IH 6.3 WEM GE		100	0386260000

Marking systems

DEK 6,5

DEK 6

For detailed information on other accessories and applications see "Accessories"

Modular terminals with screwless connections

AST 5

4 mm²

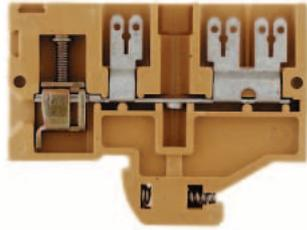

6.5 x 58 x 46
20 / 6
0.2 ... 6

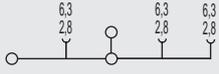

IEC 60947-7-1 / IEC 61210

IEC	UL	CSA	EN 50019
800	300	300	
20	13	16	
4	AWG 22... 12 AWG 24... 12		
	6 / 3		
	A4 / V2		



Rated connection	Additional connection
0.5...6 / 1.5...2.5	
0.5...4 / 0.5...4	
0.5...1.0 (M3)	
12 / 3.5 x 0.6	

For tab connection use a insulated sleeve.

Type	Qty.	Order No.
AST 5 SF 6.3/2.8	50	0479260000
AST 5 SF 6.3	50	0334560000

Type	Current [A]	Qty.	Order No.
Q 2 SAK4	41	50	0336700000
Q 3 SAK4	41	50	0336800000
Q 4 SAK4	41	50	0336900000
Q 10 SAK4	41	20	0368800000

Width [mm]			
AP AST1+5 KRG	3	20	0266420000
TW SAKS2 HP/DBR/2	2	20	0607000000
TSCH 1	2	100	0319160000
PS 2.3 RT		20	0180400000
STB 14/D5/2.3/M3 SAK2.5		50	0168600000
IH 2.8 DB		100	0386060000
IH 6.3 WEM GE		100	0386260000

DEK 6,5

SAK 4 S

4 mm²



6.5 x 40 x 51.5
20 / 6
0.13 ... 6

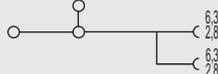

IEC 60947-7-1 / IEC 61210

IEC	UL	CSA	EN 50019
500	300	300	
20	13	13	
4	AWG 26... 12 AWG 26... 12		
	6 / 3		
	A4 / V2		



Rated connection	Additional connection
0.33...6 / 1.5...4	
0.5...4 / 0.5...4	
0.5...1.0 (M3)	
12 / 3.5 x 0.6	

For tab connection use a insulated sleeve.

Type	Qty.	Order No.
SAK 4 S 6.3/2.8	100	0401260000

Type	Current [A]	Qty.	Order No.
QL 2 SAK4	32	100	0130600000
QL 3 SAK4	32	100	0130700000
QL 4 SAK4	32	50	0130800000
QL 10 SAK4	32	20	0338200000

Width [mm]			
AP SAK4-10	1.5	20	0117960000
TW 4 SAK4-10	1.5	20	0130160000
IH 2.8 DB		100	0386060000
IH 6.3 WEM GE		100	0386260000

DEK 6,5

SAK 4 SS

4 mm²



6.5 x 40 x 51.5
20

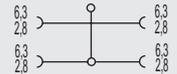

IEC 60947-7-1 / IEC 61210

IEC	UL	CSA	EN 50019
500	600	300	
20	13	13	
4	AWG 18... 14 AWG 18... 14		
	6 / 3		
	/ V2		



Rated connection	Additional connection

For tab connection use a insulated sleeve.

Type	Qty.	Order No.
SAK 4 SS 6.3/2.8	100	0479660000
SAK 4 SS 6.3/PA	100	0352960000

Type	Current [A]	Qty.	Order No.
QL 2 SAK4	32	100	0130600000
QL 3 SAK4	32	100	0130700000
QL 4 SAK4	32	50	0130800000
QL 10 SAK4	32	20	0338200000

Width [mm]			
AP SAK4-10 KRG	1.5	20	0117920000
TW SAK4-10 KRG	2.5	20	0130120000
IH 2.8 DB		100	0386060000
IH 6.3 WEM GE		100	0386260000

DEK 6,5

Modular terminals with screwless connections

with push-on connection
TS 32 / PA

DK 4 S

4 mm²

DK 4 S 2.8

4 mm²

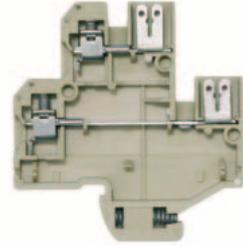
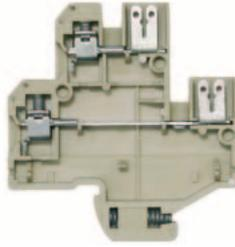

When using ATEX certified components in hazardous area applications the installation instructions and the rated data for accessories in the technical appendix must be considered.

Width/Length/Height with TS32	mm
Max. current / max. cond. cross-section	A/mm ²
Max. clamping range	mm ²

6 x 54 x 59.5	6.3 2.8
20 / 4	6.3 2.8
0.33 ... 4	

6 x 54 x 59.5	2.8
10 / 4	2.8
0.33 ... 4	

Technical data

Rated data	
Rated voltage	V
Rated current	A
Rated cross-section	mm ²
Rated impulse voltage / Pollution severity	kV/-
Plug gauge IEC 60-947-1 / flammability class acc. UL 94 Approvals	

IEC 60947-7-1 / IEC 61210			
IEC	UL	CSA	EN 50019
400	300	300	
10	10	10	
4	AWG 22... 12	AWG 22... 12	
6 / 3			
A3 / V2			

IEC 60947-7-1 / IEC 61210			
IEC	UL	CSA	EN 50019
400	300	300	
10	10	10	
4	AWG 22... 12	AWG 22... 12	
6 / 3			
A3 / V2			

Clampable conductors (H05V/H07V)	
Solid / stranded	mm ²
Flexible / flexible w. wire end ferrule	mm ²
Tightening torque range (clamping screw)	Nm
Stripping length / blade size	mm / -

Rated connection	Additional connection
0.5...4 / 1.5...4	
0.5...4 / 0.5...2.5	
0.5...0.8 (M 3)	
8 / 3.5 x 0.6	

Rated connection	Additional connection
0.5...4 / 1.5...4	
0.5...4 / 0.5...2.5	
0.5...0.8 (M 3)	
8 / 3.5 x 0.6	

2 clampable conductors of equal cross-section	
Solid / stranded	mm ²
Flexible / flexible w. wire end ferrule	mm ²

--	--

--	--

Information

For tab connection use a insulated sleeve.

For tab connection use a insulated sleeve.

Order data

Version	
slotted	
Unslotted	
slotted blue	
Unslotted blue	

Type	Qty.	Order No.
DK 4S SF 6.3/2.8	100	0631260000

Type	Qty.	Order No.
DK 4S SF 4X2.8	100	0631160000

Information

Accessories

Cross-connection	
	2-pole
	3-pole
	4-pole
(Q)	10-pole

Type	Current [A]	Qty.	Order No.
Q 2 AKZ4	32	50	0336400000
Q 3 AKZ4	32	50	0336500000
Q 4 AKZ4	32	50	0336600000
Q 10 AKZ4	32	20	0368600000

Type	Current [A]	Qty.	Order No.
Q 2 AKZ4	32	50	0336400000
Q 3 AKZ4	32	50	0336500000
Q 4 AKZ4	32	50	0336600000
Q 10 AKZ4	32	20	0368600000

Plug adapter	
	2-pole
	3-pole
	4-pole
	5-polig
	8-pole

End plate / partition	
End plate	
Partition	
Partition disc	

Width [mm]			
AP DK4S	20		0631360000
TSCH 6 DKI S4	5	100	0190260000

Width [mm]			
AP DK4S	20		0631360000
TSCH 6 DKI S4	5	100	0190260000

Testing/Checking	
for testing	PS
wired terminal strips	StB

PS 2.3 RT	20		0180400000
STB 8.5/D4/2.3/M2.5 AKZ	50		0215700000

PS 2.3 RT	20		0180400000
STB 8.5/D4/2.3/M2.5 AKZ	50		0215700000

Insulating sleeve	
	2,8
	6,3

IH 2.8 DB	100		0386060000
IH 6.3 WEM GE	100		0386260000

IH 2.8 DB	100		0386060000
-----------	-----	--	------------

Marking systems

DEK 6

DEK 6

For detailed information on other accessories and applications see "Accessories"

Modular terminals with screwless connections

with Termi-Point/Wire-Wrap connection
TS 32 / PA

SAK 2.5 T 1x1

2.5 mm²

DK 4 T

4 mm²



When using ATEX certified components in hazardous area applications the installation instructions and the rated data for accessories in the technical appendix must be considered.

Width/Length/Height with TS32	mm
Max. current / max. cond. cross-section	A/mm ²
Max. clamping range	mm ²

6 x 36.5 x 67	
8 / 6	
0.33 ... 6	

6 x 50 x 77.5	
10 / 6	
0.5 ... 6	

Technical data

Rated data	
Rated voltage	V
Rated current	A
Rated cross-section	mm ²
Rated impulse voltage / Pollution severity	kV/-
Plug gauge IEC 60-947-1 / flammability class acc. UL 94	
Approvals	

IEC 60947-7-1 / VDE 41611-4

IEC	UL	CSA	EN 50019
250		300	
8		10	
2.5		AWG 22... 12	
		4 / 3	
		A3 / V2	

IEC 60947-7-1 / IEC 61210

IEC	UL	CSA	EN 50019
250			
10			
4			
		4 / 3	
		A3 / V2	

Clampable conductors (H05V/H07V)	
Solid / stranded	mm ²
Flexible / flexible w. wire end ferrule	mm ²
Tightening torque range (clamping screw)	Nm
Stripping length / blade size	mm / -

Rated connection	Additional connection
0.5...6 / 0.5...2.5	
0.5...4 / 0.5...2.5	
0.4...0.7 (M 2.5)	
12 / 3.5 x 0.6	

Rated connection	Additional connection
0.5...6 / 1.5...4	
0.5...4 / 0.5...2.5	
0.6...0.8 (M 3)	
8 / 3.5 x 0.6	

2 clampable conductors of equal cross-section	
Solid / stranded	mm ²
Flexible / flexible w. wire end ferrule	mm ²

Information

Order data

Version	
right	
horizontal right	
vertical right	
2 x vertical	
left	
vertical left	

Type	Qty.	Order No.
SAK 2.5 SW 1X1	100	0108560000

Type	Qty.	Order No.
DK 4 SW 1X1	50	0536560000

Information

Accessories

Cross-connection output-side (screwable)			
	2-pole	Q 2 SAK2.5	41 50 0337000000
	3-pole	Q 3 SAK2.5	41 50 0337100000
	4-pole	Q 4 SAK2.5	41 50 0337200000
	10-pole	Q 10 SAK2.5	41 20 0368700000

End plate / partition			
End plate	AP SAK2.5	1.5	20 0279560000
End plate blue			
Partition	TW SAK2.5	2.5	20 0302860000
Partition			
Partition disc	TSCH 1	2	100 0319160000

External cross-connection			
		Width [mm]	
2-pole			
3-pole			
4-pole			

Cover			
Cover			
Plombierschraube			

Testing/Checking			
for testing	PS	PS 2.3 RT	20 0180400000
wired terminal strips	StB	STB 8.5/5/2.3/M3 SAK2.5	50 0280600000

Marking systems			
		DEK 6	

For detailed information on other accessories and applications see "Accessories"

Type	Current [A]	Qty.	Order No.
Q 2 AKZ4	32	50	0336400000
Q 3 AKZ4	32	50	0336500000
Q 4 AKZ4	32	50	0336600000
Q 10 AKZ4	32	20	0368600000

Type	Current [A]	Qty.	Order No.
AP DK4	1.5	20	0359260000
AP DK4 BL	1.5	20	0359280000
TW SAKS2 HP/DBR/2	2	20	0607000000
TSCH 4 AKZ4	6	100	0363360000

Width [mm]			
QB 2 WI RA6 IS	50		0482700000
QB 3 WI RA6 IS	50		0482800000
QB 4 WI RA6 IS	50		0482900000

Cover			

Testing/Checking			
PS 2.3 RT	20	0180400000	
STB 8.5/D4/2.3/M2.5 AKZ	50	0215700000	

Marking systems			
		DEK 6	

Modular terminals with screwless connections

with solder connection
TS 32 / PA

DK 4 T 0.8x1.6

4 mm²

DK 4 T / DK 4 QT 0.8x2.4

4 mm²



When using ATEX certified components in hazardous area applications the installation instructions and the rated data for accessories in the technical appendix must be considered.

Width/Length/Height with TS32	mm
Max. current / max. cond. cross-section	A/mm ²
Max. clamping range	mm ²

6 x 50 x 77.5	0.8 x 1.6
10 / 6	0.8 x 1.6
0.5 ... 6	0.8 x 1.6

6 x 50 x 77.5	0.8 x 2.4
10 / 6	0.8 x 2.4
0.5 ... 6	0.8 x 2.4

Technical data

Rated data	
Rated voltage	V
Rated current	A
Rated cross-section	mm ²
Rated impulse voltage / Pollution severity	kV/-
Plug gauge IEC 60-947-1 / flammability class acc. UL 94	
Approvals	

IEC 60947-7-1 / IEC 61210				
IEC	UL	CSA	EN 50019	
250				
10				
4				
		4 / 3		
		A3 / V2		

IEC 60947-7-1 / IEC 61210				
IEC	UL	CSA	EN 50019	
250				
10				
4				
		4 / 3		
		A3 / V2		

Clampable conductors (H05V/H07V)	
Solid / stranded	mm ²
Flexible / flexible w. wire end ferrule	mm ²
Tightening torque range (clamping screw)	Nm
Stripping length / blade size	mm / -

Rated connection	Additional connection
0.5...6 / 1.5...4	
0.5...4 / 0.5...2.5	
0.6...0.8 (M3)	
8 / 3.5 x 0.6	

Rated connection	Additional connection
0.5...6 / 1.5...4	
0.5...4 / 0.5...2.5	
0.6...0.8 (M3)	
8 / 3.5 x 0.6	

2 clampable conductors of equal cross-section	
Solid / stranded	mm ²
Flexible / flexible w. wire end ferrule	mm ²

Information

Order data

Version	Type	Qty.	Order No.
right			
horizontal right	DK 4 ST WA 1.6	50	0370460000
vertical right	DK 4 ST SE 1.6	50	0370360000
2 x vertical			
left			
vertical left			

Type	Qty.	Order No.

Type	Qty.	Order No.
DK 4Q ST WA 2.4	50	1398760000
DK 4 ST SE 2.4	50	0527760000

Information

Accessories

Cross-connection output-side (screwable)	
2-pole	Q 2 AKZ4
3-pole	Q 3 AKZ4
4-pole	Q 4 AKZ4
10-pole	Q 10 AKZ4

Type	Current [A]	Qty.	Order No.
Q 2 AKZ4	32	50	0336400000
Q 3 AKZ4	32	50	0336500000
Q 4 AKZ4	32	50	0336600000
Q 10 AKZ4	32	20	0368600000

Type	Current [A]	Qty.	Order No.
Q 2 AKZ4	32	50	0336400000
Q 3 AKZ4	32	50	0336500000
Q 4 AKZ4	32	50	0336600000
Q 10 AKZ4	32	20	0368600000

End plate / partition	
End plate	AP DK4
End plate blue	AP DK4 BL
Partition	TW SAKS2 HP/DBR/2
Partition disc	TSCH 4 AKZ4

Type	Width [mm]	Qty.	Order No.
AP DK4	1.5	20	0359260000
AP DK4 BL	1.5	20	0359280000
TW SAKS2 HP/DBR/2	2	20	0607000000
TSCH 4 AKZ4	6	100	0363360000

Type	Width [mm]	Qty.	Order No.
AP DK4	1.5	20	0359260000
AP DK4 BL	1.5	20	0359280000
TW SAKS2 HP/DBR/2	2	20	0607000000
TSCH 4 AKZ4	6	100	0363360000

External cross-connection	
2-pole	QB 2 WI RA6 IS
3-pole	QB 3 WI RA6 IS
4-pole	QB 4 WI RA6 IS

Type	Width [mm]	Qty.	Order No.
QB 2 WI RA6 IS	50	50	0482700000
QB 3 WI RA6 IS	50	50	0482800000
QB 4 WI RA6 IS	50	50	0482900000

Type	Width [mm]	Qty.	Order No.
QB 2 WI RA6 IS	50	50	0482700000
QB 3 WI RA6 IS	50	50	0482800000
QB 4 WI RA6 IS	50	50	0482900000

Cover	
Cover	
Plombierschraube	

Testing/Checking	
for testing	PS
wired terminal strips	StB

Type	Qty.	Order No.
PS 2.3 RT	20	0180400000
STB 8.5/D4/2.3/M2.5 AKZ	50	0215700000

Type	Qty.	Order No.
PS 2.3 RT	20	0180400000
STB 8.5/D4/2.3/M2.5 AKZ	50	0215700000

Marking systems	
	DEK 6

Marking systems	
	DEK 6

For detailed information on other accessories and applications see "Accessories"

Modular terminals with screwless connections

SAKRT

4 mm²



6.5 x 42 x 40.5
8 / 4
0.5 ... 4



IEC 60947-7-1 / VDE 41611-4 / VDE 0100-537

IEC	UL	CSA	EN 50019
250			
8			
4			
	4 / 3		
	A3 / V2		

Rated connection	Additional connection
0.5...4 / 1.5...4	
0.5...4 / 0.5...2.5	
0.5...1.0 (M 3)	
8 / 3.5 x 0.6	

Type	Qty.	Order No.
SAKR ST SE 2.4	100	0545060000
SAKR WS 1X1	100	0587460000

Type	Current [A]	Qty.	Order No.
AP SAKR BE	1.5	20	0211360000
TW SAKS2 HP/DBR/2	2	20	0607000000
Width [mm]			
QB 2 WI RA6 IS		50	0482700000
QB 3 WI RA6 IS		50	0482800000
QB 4 WI RA6 IS		50	0482900000
PS 2.3 RT		20	0180400000
DEK 6,5			

SAK 2.5 L

2.5 mm²



6 x 44 x 46.5
17.5 / 6
0.33 ... 6

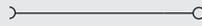

IEC 60947-7-1 / IEC 60068-2-20

IEC	UL	CSA	EN 50019
250		300	
17.5		10	
2.5		AWG 22... 12	
	4 / 3		
	A3 / V2		

Rated connection	Additional connection
0.5...6 / 0.5...2.5	
0.5...4 / 0.5...2.5	
0.4...0.7 (M 2.5)	
12 / 3.5 x 0.6	

Type	Qty.	Order No.
SAK 2.5 SL	100	0351460000
SAK 2.5 LS	100	0544160000

Type	Current [A]	Qty.	Order No.
Q 2 SAK2.5	41	50	0337000000
Q 3 SAK2.5	41	50	0337100000
Q 4 SAK2.5	41	50	0337200000
Q 10 SAK2.5	41	20	0368700000
AP SAK2.5	1.5	20	0279560000
AP SAK2.5 BL	1.5	20	0279580000
TW SAK2.5	2.5	20	0302860000
TSCH 1	2	100	0319160000
Width [mm]			
AD 4 AKZ4		50	0303400000
BFSC M3X22 PA/RT		100	0128900000
PS 2.3 RT		20	0180400000
STB 8.5/5/2.3/M3 SAK2.5		50	0280600000
DEK 6			

SAK 2.5 LL

1.5 mm²

solder connection both sides

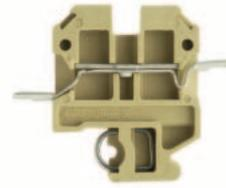

6 x 54 x 46.5
17.5 / 3.3
0.13 ... 3.3



IEC 60947-7-1 / IEC 60068-2-20

IEC	UL	CSA	EN 50019
250		300	
17.5		10	
1.5		AWG 26... 12	
	4 / 3		
	/ V2		

Rated connection	Additional connection

Type	Qty.	Order No.
SAK 2.5 LL	100	0323660000

Type	Current [A]	Qty.	Order No.
Q 2 SAK2.5	41	50	0337000000
Q 3 SAK2.5	41	50	0337100000
Q 4 SAK2.5	41	50	0337200000
Q 10 SAK2.5	41	20	0368700000
AP SAK2.5	1.5	20	0279560000
AP SAK2.5 BL	1.5	20	0279580000
TW SAK2.5	2.5	20	0302860000
TSCH 1	2	100	0319160000
Width [mm]			
AD 4 AKZ4		50	0303400000
BFSC M3X22 PA/RT		100	0128900000
PS 2.3 RT		20	0180400000
STB 8.5/5/2.3/M3 SAK2.5		50	0280600000
DEK 6			

with solder connection
TS 32 / PA

B

Modular terminals with screwless connections

with solder connection
TS 32 / PA

SAKR L

4 mm²

SAKR L STB 6

4 mm²

When using ATEX certified components in hazardous area applications the installation instructions and the rated data for accessories in the technical appendix must be considered.

Width/Length/Height with TS32 mm
Max. current / max. cond. cross-section A/mm²
Max. clamping range mm²

6.5 x 50 x 40.5
10 / 4
0.33 ... 4

6.5 x 50 x 40.5
10 / 4
0.5 ... 4



B

Technical data

Rated data	
Rated voltage	V
Rated current	A
Rated cross-section	mm ²
Rated impulse voltage / Pollution severity	kV/-
Plug gauge IEC 60-947-1 / flammability class acc. UL 94	
Approvals	

IEC 60947-7-1 / IEC 60068-2-20 / VDE 0100-537			
IEC	UL	CSA	EN 50019
250	300	300	
10	10	10	
4	AWG 22...12	AWG 22...12	
		4 / 3	
		A3 / V2	

IEC 60947-7-1 / IEC 60068-2-20 / VDE 0100-537			
IEC	UL	CSA	EN 50019
250			
10			
4			
		4 / 3	
		A3 / V2	

Clampable conductors (H05V/H07V)	
Solid / stranded	mm ²
Flexible / flexible w. wire end ferrule	mm ²
Tightening torque range (clamping screw)	Nm
Stripping length / blade size	mm / -

Rated connection	Additional connection
0.5...4 / 0.5...4	
0.5...4 / 0.5...2.5	
0.5...1.0 (M 3)	
8 / 3.5 x 0.6	

Rated connection	Additional connection
0.5...4 / 1.5...4	
0.5...4 / 0.5...2.5	
0.5...1.0 (M 3)	
8 / 3.5 x 0.6	

2 clampable conductors of equal cross-section	
Solid / stranded	mm ²
Flexible / flexible w. wire end ferrule	mm ²

Information	

The tightening torque is 0.5-0.7 Nm for disconnect terminals with sockets.

Order data

Version	
	beige
	blue

Type	Qty.	Order No.
SAKR LS	100	0412460000

Type	Qty.	Order No.
SAKR LS 2STB	100	0518160000
SAKR SL 2STB BL	100	0572680000

Information	

Accessories

Cross-connection, screwable	
	2-pole
	3-pole
	4-pole
	10-pole
	Connecting sleeve
	Fixing screw
	Fuse cartridges

Type	Current [A]	Qty.	Order No.
QB 2 WI RA6 IS	27	50	0482700000
QB 3 WI RA6 IS	27	50	0482800000
QB 4 WI RA6 IS	27	50	0482900000

Type	Current [A]	Qty.	Order No.
QB 2 WI RA6 IS	27	50	0482700000
QB 3 WI RA6 IS	27	50	0482800000
QB 4 WI RA6 IS	27	50	0482900000

Cross-connection saddle	
	Cross-connection saddle
	Connecting sleeve
	Fixing screw

Socket / Test plug	
	Socket
	Test plug

Type	Qty.	Order No.
STB 6/D3.7/2.3/M3 SAKR	100	0379400000
PS 2.3 RT	20	0180400000

Type	Qty.	Order No.
STB 6/D3.7/2.3/M3 SAKR	100	0379400000
PS 2.3 RT	20	0180400000

End plate	
	beige
	blue

Width [mm]	
AP SAKR BE	1.5 20 0211380000
AP SAKR BL	1.5 20 0211380000

Width [mm]	
AP SAKR BE	1.5 20 0211380000
AP SAKR BL	1.5 20 0211380000

Partition / Partition disc	
	beige
	blue
	Partition disc

Width [mm]	
TW SAKS2 HP/DBR/2	2 20 0607000000

Width [mm]	
TW SAKS2 HP/DBR/2	2 20 0607000000

Cover / fixing screw (plastic)	
	Cover
	Fixing screw (plastic)

Marking systems	
	DEK 6,5

Marking systems	
	DEK 6,5

Detailed information on all versions in chapter accessories.

QB 25 blank, see chapter accessories. To use twin ferrules ZH 0,5 to ZH 1,5 is possible.

Modular terminals with screwless connections

SAKR LL

1.5 mm²

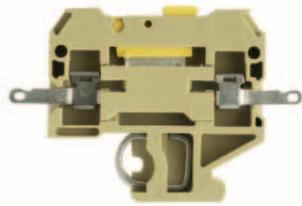

6.5 x 58 x 40.5
10 / 1.5
0.5 ... 1.5



IEC 60947-7-1 / IEC 60068-2-20 / VDE 0100-537

IEC	UL	CSA	EN 50019
250		300	
10		10	
1.5		AWG 22...12	
	4 / 3		
	/ V2		



Rated connection **Additional connection**



SAKR LL STB 6

1.5 mm²

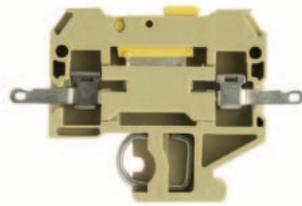

6.5 x 58 x 40.5
10 / 1.5
0.5 ... 1.5

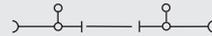

IEC 60947-7-1 / IEC 60068-2-20 / VDE 0100-537

IEC	UL	CSA	EN 50019
250		300	
10		10	
1.5		AWG 22...12	
	4 / 3		
	/ V2		



Rated connection **Additional connection**

/ 3.5 x 0.6

Tightening torque for the test sockets 0.5 ... 0.7 Nm

Type	Qty.	Order No.
SAKR LL 2STB	100	0294260000

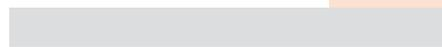

Type	Current [A]	Qty.	Order No.
SAKR LL		100	0464460000

Type	Current [A]	Qty.	Order No.
Width [mm]			
AP SAKR BE	1.5	20	0211380000
AP SAKR BL	1.5	20	0211380000
Width [mm]			
TW SAKS2 HP/DBR/2	2	20	0607000000
Width [mm]			
DEK 6,5			

DEK 6,5

Type	Current [A]	Qty.	Order No.
SAKR LL 2STB		100	0294260000

Type	Current [A]	Qty.	Order No.
PS 2.3 RT		20	0180400000
Width [mm]			
AP SAKR BE	1.5	20	0211380000
AP SAKR BL	1.5	20	0211380000
Width [mm]			
TW AST1/PA HP/DBR/0.5	0.5	20	0474700000
Width [mm]			
DEK 6,5			

DEK 6,5

Modular terminals with screwless connections

with push-on connection
TS 32 / KrG

AST 1

2.5 mm²

AST 3

2.5 mm²

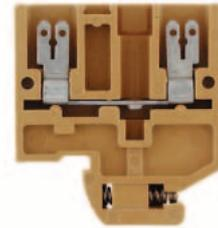
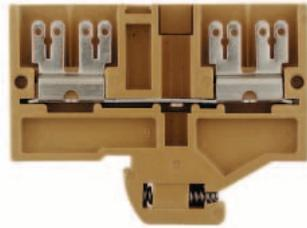

When using ATEX certified components in hazardous area applications the installation instructions and the rated data for accessories in the technical appendix must be considered.

Width/Length/Height with TS32	mm
Max. current / max. cond. cross-section	A/mm ²
Max. clamping range	mm ²

6.5 x 58 x 46	6.3 6.3	2.8 2.8	6.3 6.3
20			

6.5 x 40 x 46	6.3	2.8	6.3
20			

Technical data

Rated data	
Rated voltage	V
Rated current	A
Rated cross-section	mm ²
Rated impulse voltage / Pollution severity	kV/-
Plug gauge IEC 60-947-1 / flammability class acc. UL 94	
Approvals	

IEC 60947-7-1 / IEC 61210

IEC	UL	CSA	EN 50019
800	600	300	
20	13	16	
2.5			
	6 / 3		
	/ 5VA		

IEC 60947-7-1 / IEC 61210

IEC	UL	CSA	EN 50019
800			
20	13	16	
2.5			
	6 / 3		
	/ 5VA		

Clampable conductors (H05V/H07V)	
Solid / stranded	mm ²
Flexible / flexible w. wire end ferrule	mm ²
Tightening torque range (clamping screw)	Nm
Stripping length / blade size	mm / -



Rated connection	Additional connection



Rated connection	Additional connection

2 clampable conductors of equal cross-section	
Solid / stranded	mm ²
Flexible / flexible w. wire end ferrule	mm ²

Information

For tab connection use a insulated sleeve.

For tab connection use a insulated sleeve.

Order data

Version	
	slotted
	Unslotted
	slotted blue
	Unslotted blue

Type	Qty.	Order No.
AST 1 6.3/2.8 KRG	50	0478220000
AST 1 6.3 KRG	50	0266320000

Type	Qty.	Order No.
AST 3 6.3/2.8 KRG	100	0442420000
AST 3 6.3 KRG	100	0298020000
AST 3 6.3/2.8 KRG/BL	n.a.	0442470000

Information

Accessories

Cross-connection	
	2-pole
	3-pole
	4-pole
	10-pole

Type	Current [A]	Qty.	Order No.
Q 2 SAK4	41	50	0336700000
Q 3 SAK4	41	50	0336800000
Q 4 SAK4	41	50	0336900000
Q 10 SAK4	41	20	0368800000

Type	Current [A]	Qty.	Order No.
Q 2 SAK4	41	50	0336700000
Q 3 SAK4	41	50	0336800000
Q 4 SAK4	41	50	0336900000
Q 10 SAK4	41	20	0368800000

Plug adapter	
	2-pole
	3-pole
	4-pole
	5-polig
	8-pole

	STA 2.5/2	100	0165860000
	STA 2.5/3	50	0165960000
	STA 2.5/4	50	0190360000
	STA 2.5/5	50	0166060000
	STA 2.5/8	50	0166160000

End plate / partition	
	End plate
	Partition
	Partition disc

	Width [mm]		
AP AST1+5 KRG	3	20	0266420000
TW SAKS2 HP/DBR/2	2	20	0607000000
TSCH 1	2	100	0319160000

	Width [mm]		
AP AST3+4 KRG	3	20	0298120000
TW SAKS2 HP/DBR/2	2	20	0607000000
TSCH 1	2	100	0319160000

Testing/Checking	
for testing	PS
wired terminal strips	StB

	PS 2.3 RT	20	0180400000
	STB 14/D5/2.3/M3 SAK2.5	50	0168600000

	PS 2.3 RT	20	0180400000
	STB 14/D5/2.3/M3 SAK2.5	50	0168600000

Insulating sleeve	
	2,8
	6,3

	IH 2.8 DB	100	0386060000
	IH 6.3 WEM GE	100	0386260000

	IH 2.8 DB	100	0386060000
	IH 6.3 WEM GE	100	0386260000

Marking systems

DEK 6,5

DEK 6

For detailed information on other accessories and applications see "Accessories"

Modular terminals with screwless connections

AST 4

2.5 mm²

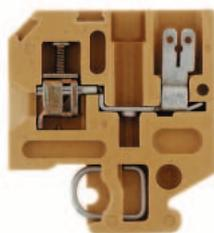

6.2 x 40 x 46
20 / 4
0.2 ... 4

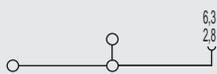

IEC 60947-7-1 / IEC 61210

IEC	UL	CSA	EN 50019
800	300	300	
20	13	16	
2.5	AWG 22... 12	AWG 24... 12	
6 / 3			
A3 / 5VA			



Rated connection	Additional connection
0.5...4 / 1.5...2.5	
0.5...2.5 / 0.5...2.5	
0.4...0.7 (M 2.5)	
9 / 3.5 x 0.6	

For tab connection use a insulated sleeve.

Type	Qty.	Order No.
AST 4 SF 6.3/2.8 KRG	100	0439120000
AST 4 SF 6.3 KRG	100	0321220000

Type	Current [A]	Qty.	Order No.
Q 2 SAK4	41	50	0336700000
Q 3 SAK4	41	50	0336800000
Q 4 SAK4	41	50	0336900000
Q 10 SAK4	41	20	0368800000
<hr/>			
STA 2.5/2		100	0165860000
STA 2.5/3		50	0165960000
STA 2.5/4		50	0190360000
STA 2.5/5		50	0166060000
STA 2.5/8		50	0166160000
<hr/>			
Width [mm]			
AP AST3+4 KRG	3	20	0298120000
TW SAKS2 HP/DBR/2	2	20	0607000000
TSCH 1	2	100	0319160000
<hr/>			
PS 2.3 RT		20	0180400000
STB 14/D5/2.3/M3 SAK2.5		50	0168600000
<hr/>			
IH 2.8 DB		100	0386060000
IH 6.3 WEM GE		100	0386260000

DEK 6

AST 5

4 mm²

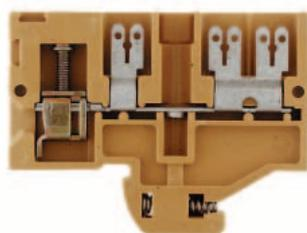

6.5 x 58 x 46
20 / 6
0.2 ... 6

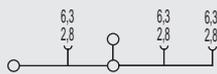

IEC 60947-7-1 / IEC 61210

IEC	UL	CSA	EN 50019
800	300	300	
20	13	16	
4	AWG 22... 12	AWG 24... 12	
6 / 3			
A4 / 5VA			



Rated connection	Additional connection
0.5...6 / 1.5...2.5	
0.5...4 / 0.5...4	
0.5...1.0 (M 3)	
12 / 3.5 x 0.6	

For tab connection use a insulated sleeve.

Type	Qty.	Order No.
AST 5 SF 6.3/2.8 KRG	50	0479220000
AST 5 SF 6.3 KRG	50	0334520000

Type	Current [A]	Qty.	Order No.
Q 2 SAK4	41	50	0336700000
Q 3 SAK4	41	50	0336800000
Q 4 SAK4	41	50	0336900000
Q 10 SAK4	41	20	0368800000
<hr/>			
Width [mm]			
AP AST1+5 KRG	3	20	0266420000
TW SAKS2 HP/DBR/2	2	20	0607000000
TSCH 1	2	100	0319160000
<hr/>			
PS 2.3 RT		20	0180400000
STB 14/D5/2.3/M3 SAK2.5		50	0168600000
<hr/>			
IH 2.8 DB		100	0386060000
IH 6.3 WEM GE		100	0386260000

DEK 6,5

SAK 4 S

4 mm²

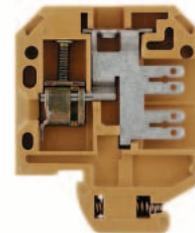

6.5 x 40 x 51.5
20 / 6
0.13 ... 6

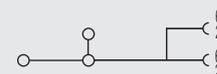

IEC 60947-7-1 / IEC 61210

IEC	UL	CSA	EN 50019
500	300	300	
20	13	13	
4	AWG 26... 12	AWG 26... 12	
6 / 3			
A4 / 5VA			



Rated connection	Additional connection
0.33...6 / 1.5...4	
0.5...4 / 0.5...4	
0.5...1.0 (M 3)	
12 / 3.5 x 0.6	

For tab connection use a insulated sleeve.

Type	Qty.	Order No.
SAK 4 S 6.3/2.8/KRG	100	0401220000
SAK 4 S 6.3 KRG	100	0479520000

Type	Current [A]	Qty.	Order No.
QL 2 SAK4	32	100	0130600000
QL 3 SAK4	32	100	0130700000
QL 4 SAK4	32	50	0130800000
QL 10 SAK4	32	20	0338200000
<hr/>			
Width [mm]			
AP SAK4-10 KRG	1.5	20	0117920000
TW SAK4-10 KRG	2.5	20	0130120000
<hr/>			
IH 2.8 DB		100	0386060000
IH 6.3 WEM GE		100	0386260000

DEK 6,5

Modular terminals with screwless connections

with push-on connection
TS 32 / KrG

SAK 4 SS

4 mm²



When using ATEX certified components in hazardous area applications the installation instructions and the rated data for accessories in the technical appendix must be considered.

Width/Length/Height with TS32	mm
Max. current / max. cond. cross-section	A/mm ²
Max. clamping range	mm ²

6.5 x 40 x 51.5	
20	

B

Technical data

Rated data	
Rated voltage	V
Rated current	A
Rated cross-section	mm ²
Rated impulse voltage / Pollution severity	kV/-
Plug gauge IEC 60-947-1 / flammability class acc. UL 94	
Approvals	

IEC 60947-7-1 / IEC 61210

IEC	UL	CSA	EN 50019
500	600	300	
20	13	13	
4	AWG 18... 14	AWG 18... 14	
6 / 3			
/ 5VA			

Clampable conductors (H05V/H07V)

Solid / stranded	mm ²
Flexible / flexible w. wire end ferrule	mm ²
Tightening torque range (clamping screw)	Nm
Stripping length / blade size	mm / -

2 clampable conductors of equal cross-section

Solid / stranded	mm ²
Flexible / flexible w. wire end ferrule	mm ²

Information

For tab connection use a insulated sleeve.

Order data

Version	
slotted	
Unslotted	
slotted blue	
Unslotted blue	

Type	Qty.	Order No.
SAK 4 SS 6.3/2.8 KRG	100	0479620000
SAK 4 SS 6.3/KRG	100	0352920000
SAK 4 SS 6.3/2.8 KRG/BL	100	0479670000
SAK 4 SS 6.3 KRG/BL	100	0352970000

Information

Accessories

Cross-connection	
	2-pole
	3-pole
	4-pole
	10-pole

Type	Current [A]	Qty.	Order No.
QL 2 SAK4	32	100	0130600000
QL 3 SAK4	32	100	0130700000
QL 4 SAK4	32	50	0130800000
QL 10 SAK4	32	20	0338200000

Plug adapter

2-pole	
3-pole	
4-pole	
5-polig	
8-pole	

End plate / partition

End plate	
Partition	
Partition disc	

Testing/Checking

for testing	PS
wired terminal strips	StB

Insulating sleeve

2,8	
6,3	

Width [mm]			
AP SAK4-10 KRG	1.5	20	0117920000
TW SAK4-10 KRG	2.5	20	0130120000

IH 2.8 DB	100	0386060000
IH 6.3 WEM GE	100	0386260000

Marking systems

DEK 6,5

For detailed information on other accessories and applications see "Accessories"

Modular terminals with screwless connections

with Termi-Point/Wire-Wrap connection
TS 32 / KrG

SAK 2.5 T 1x1

2.5 mm²

SAK 2.5 T 0.8x1.6

2.5 mm²

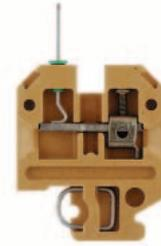
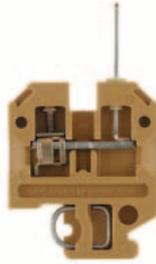

When using ATEX certified components in hazardous area applications the installation instructions and the rated data for accessories in the technical appendix must be considered.

Width/Length/Height with TS32 mm
Max. current / max. cond. cross-section A/mm²
Max. clamping range mm²

6 x 36.5 x 67
8 / 6
0.5 ... 6

6 x 36.5 x 67
8 / 6
0.33 ... 6

Technical data

Rated data	
Rated voltage	V
Rated current	A
Rated cross-section	mm ²
Rated impulse voltage / Pollution severity	kV/-
Plug gauge IEC 60-947-1 / flammability class acc. UL 94	
Approvals	

IEC 60947-7-1 / VDE 41611-4

IEC	UL	CSA	EN 50019
250		300	
8		10	
2.5		AWG 22... 12	
		4 / 3	
		A3 / 5VA	

IEC 60947-7-1 / VDE 41611-4

IEC	UL	CSA	EN 50019
250		300	
8		10	
2.5		AWG 22... 12	
		4 / 3	
		A3 / 5VA	

Clampable conductors (H05V/H07V)	
Solid / stranded	mm ²
Flexible / flexible w. wire end ferrule	mm ²
Tightening torque range (clamping screw)	Nm
Stripping length / blade size	mm / -

Rated connection	Additional connection
0.5...6 / 0.5...2.5	
0.5...4 / 0.5...2.5	
0.4...0.7 (M 2.5)	
12 / 3.5 x 0.6	

Rated connection	Additional connection
0.5...6 / 0.5...2.5	
0.5...4 / 0.5...2.5	
0.4...0.7 (M 2.5)	
12 / 3.5 x 0.6	

2 clampable conductors of equal cross-section	
Solid / stranded	mm ²
Flexible / flexible w. wire end ferrule	mm ²

Information

Order data

Version	
right	
horizontal right	
vertical right	
2 x vertical	
left	
vertical left	

Type	Qty.	Order No.
SAK 2.5 SW 1X1/KRG	100	0108520000

Type	Qty.	Order No.
SAK 2.5 ST WA 1.6/KRG	100	0485920000
SAK 2.5 TS SE 1.6/KRG	100	0478820000

Information

Accessories

Cross-connection output-side (screwable)		Type	Current [A]	Qty.	Order No.
2-pole		Q 2 SAK2.5	41	50	0337000000
3-pole		Q 3 SAK2.5	41	50	0337100000
4-pole		Q 4 SAK2.5	41	50	0337200000
10-pole		Q 10 SAK2.5	41	20	0368700000

End plate / partition		Type	Current [A]	Qty.	Order No.
End plate		AP SAK2.5	1.5	20	0279560000
End plate blue					
Partition		TW SAK2.5	2.5	20	0302860000
Partition					
Partition disc		TSCH 1	2	100	0319160000

External cross-connection		Type	Current [A]	Qty.	Order No.
2-pole					
3-pole					
4-pole					

Cover		Type	Current [A]	Qty.	Order No.
Cover					
Plombierschraube					

Testing/Checking		Type	Current [A]	Qty.	Order No.
for testing	PS	PS 2.3 RT		20	0180400000
wired terminal strips	StB	STB 8.5/5/2.3/M3 SAK2.5		50	0280600000

Marking systems		Type	Current [A]	Qty.	Order No.
		DEK 6			

For detailed information on other accessories and applications see "Accessories"

Type	Current [A]	Qty.	Order No.
Q 2 SAK2.5	41	50	0337000000
Q 3 SAK2.5	41	50	0337100000
Q 4 SAK2.5	41	50	0337200000
Q 10 SAK2.5	41	20	0368700000

Type	Current [A]	Qty.	Order No.
AP SAK2.5 KRG	1.5	20	0279520000
TW SAK2.5 KRG	2.5	20	0302820000
TSCH 1	2	100	0319160000

Type	Current [A]	Qty.	Order No.

Type	Current [A]	Qty.	Order No.

Type	Current [A]	Qty.	Order No.
PS 2.3 RT		20	0180400000
STB 8.5/5/2.3/M3 SAK2.5		50	0280600000

Type	Current [A]	Qty.	Order No.
DEK 6			

Modular terminals with screwless connections

with Termi-Point/Wire-Wrap connection
TS 32 / KrG

SAK 2.5 T / TT 0.8x2.4

2.5 mm²



When using ATEX certified components in hazardous area applications the installation instructions and the rated data for accessories in the technical appendix must be considered.

Width/Length/Height with TS32	mm
Max. current / max. cond. cross-section	A/mm ²
Max. clamping range	mm ²

6 x 36.5 x 67
8 / 6
0.33 ... 6

B

Technical data

Rated data	
Rated voltage	V
Rated current	A
Rated cross-section	mm ²
Rated impulse voltage / Pollution severity	kV/-
Plug gauge IEC 60-947-1 / flammability class acc. UL 94	
Approvals	

IEC 60947-7-1 / VDE 41611-4

IEC	UL	CSA	EN 50019
250		300	
8		10	
2.5		AWG 22... 12	
		4 / 3	
		A3 / 5VA	

Clampable conductors (H05V/H07V)	
Solid / stranded	mm ²
Flexible / flexible w. wire end ferrule	mm ²
Tightening torque range (clamping screw)	Nm
Stripping length / blade size	mm / -

Rated connection	Additional connection
0.5...6 / 0.5...2.5	
0.5...4 / 0.5...2.5	
0.4...0.7 (M 2.5)	
12 / 3.5 x 0.6	

2 clampable conductors of equal cross-section	
Solid / stranded	mm ²
Flexible / flexible w. wire end ferrule	mm ²

Information

Order data

Version	right
	horizontal right
	vertical right
	2 x vertical
	left
	vertical left

Type	Qty.	Order No.
SAK 2.5 ST WA 2.4	100	0687020000
SAK 2.5 TT SE 2.4/KRG	100	0485020000
SAK 2.5 TS SE 2.4/KRG	100	0371020000

Information

Accessories

Cross-connection output-side (screwable)	
	
	2-pole
	3-pole
	4-pole
	10-pole

Type	Current [A]	Qty.	Order No.
Q 2 SAK2.5	41	50	0337000000
Q 3 SAK2.5	41	50	0337100000
Q 4 SAK2.5	41	50	0337200000
Q 10 SAK2.5	41	20	0368700000

End plate / partition	
	End plate
	End plate blue
	Partition
	Partition
	Partition disc

Type	Current [A]	Qty.	Order No.
AP SAK2.5 KRG	1.5	20	0279520000
TW SAK2.5 KRG	2.5	20	0302820000
TSCH 1		2 100	0319160000

External cross-connection	
	2-pole
	3-pole
	4-pole

Width [mm]			

Cover	
	Cover
	Plombierschraube

Testing/Checking	
	for testing
	wired terminal strips

Type	Qty.	Order No.
PS 2.3 RT	20	0180400000
STB 8.5/5/2.3/M3 SAK2.5	50	0280600000

Marking systems

DEK 6

For detailed information on other accessories and applications see "Accessories"

Modular terminals with screwless connections

with solder connection
TS 32 / KrG

When using ATEX certified components in hazardous area applications the installation instructions and the rated data for accessories in the technical appendix must be considered.

Width/Length/Height with TS32	mm
Max. current / max. cond. cross-section	A/mm ²
Max. clamping range	mm ²

Technical data

Rated data	
Rated voltage	V
Rated current	A
Rated cross-section	mm ²
Rated impulse voltage / Pollution severity	kV/-
Plug gauge IEC 60-947-1 / flammability class acc. UL 94 Approvals	

Clampable conductors (H05V/H07V)

Solid / stranded	mm ²
Flexible / flexible w. wire end ferrule	mm ²
Tightening torque range (clamping screw)	Nm
Stripping length / blade size	mm / -

2 clampable conductors of equal cross-section

Solid / stranded	mm ²
Flexible / flexible w. wire end ferrule	mm ²

Information

Order data

Version	
	yellow
	blue

Information

Accessories

Cross-connection, screwable

	
	(Q)
	2-pole
	3-pole
	4-pole
	10-pole
	Connecting sleeve
	Fixing screw
	Fuse cartridges

Cross-connection saddle

	Cross-connection saddle
	Connecting sleeve
	Fixing screw

Socket / Test plug

	Socket
	Test plug

End plate

	yellow
	blue

Partition / Partition disc

	dark brown
	for tropical applications
	Partition disc

Cover / fixing screw (plastic)

	Cover
	Fixing screw (plastic)

Marking systems

	DEK 6
--	-------

Detailed information on all versions in chapter accessories.

SAK 2.5 LS

2.5 mm²

with screen shield

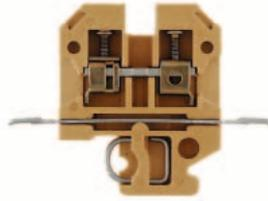

6 x 60 x 46.5
32 / 6
0.33 ... 6

IEC 60947-7-1

IEC	UL	CSA	EN 50019
250		300	
24		10	
2.5		AWG 22...12	
			4 / 3
			A3 / 5VA



Rated connection

0.5...6 / 0.5...2.5
0.5...4 / 0.5...2.5
0.4...0.7 (M 2.5)
12 / 3.5 x 0.6

Additional connection

SAK 2.5 L

2.5 mm²

with screen shield

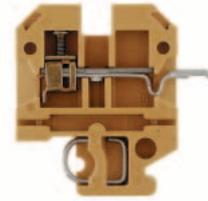

6 x 44 x 46.5
17.5 / 6
0.33 ... 6

IEC 60947-7-1 / IEC 60068-2-20

IEC	UL	CSA	EN 50019
250		300	
17.5		10	
2.5		AWG 22...12	
			4 / 3
			A3 / 5VA



Rated connection

0.5...6 / 0.5...2.5
0.5...4 / 0.5...2.5
0.4...0.7 (M 2.5)
12 / 3.5 x 0.6

Additional connection

Type	Qty.	Order No.
SAK 2.5 SL KRG	100	0351420000
SAK 2.5 SL KRG/BL	100	0351470000

Information

Type	Current [A]	Qty.	Order No.
Q 2 SAK2.5	41	50	0337000000
Q 3 SAK2.5	41	50	0337100000
Q 4 SAK2.5	41	50	0337200000
Q 10 SAK2.5	41	20	0368700000

Type	Current [A]	Qty.	Order No.
Q 2 SAK2.5	41	50	0337000000
Q 3 SAK2.5	41	50	0337100000
Q 4 SAK2.5	41	50	0337200000
Q 10 SAK2.5	41	20	0368700000
STB 8.5/5/2.3/M3 SAK2.5		50	0280600000
PS 2.3 RT		20	0180400000

Width [mm]			
AP SAK2.5L KRG	1.5	20	0309220000
AP SAK2.5L KRG BL	1.5	20	0309270000

Width [mm]			
TW SAKS2 HP/DBR/2	2	20	0607000000
TW SAK2.5 HP/TF/GE/1	1	20	0297100000
TSCH 1	2	100	0319160000

Width [mm]			
AD 4 AKZ4		50	0303400000
BFSC M3X22 PA/RT		100	0128900000

	DEK 6
--	-------

Detailed information on all versions in chapter accessories.

Modular terminals with screwless connections

with solder connection
TS 32 / KrG

SAK 2.5 LL

1.5 mm²

solder connection both sides

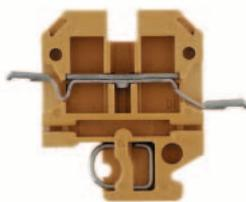

6 x 54 x 46.5
17.5 / 3.3
0.13 ... 3.3

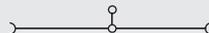

SAKR LL mit STB 6

1.5 mm²



6.5 x 58 x 40.5
10 / 1.5
0.5 ... 1.5



When using ATEX certified components in hazardous area applications the installation instructions and the rated data for accessories in the technical appendix must be considered.

Width/Length/Height with TS32 mm
Max. current / max. cond. cross-section A/mm²
Max. clamping range mm²

Technical data

Rated data	
Rated voltage	V
Rated current	A
Rated cross-section	mm ²
Rated impulse voltage / Pollution severity	kV/-
Plug gauge IEC 60-947-1 / flammability class acc. UL 94	
Approvals	

Clampable conductors (H05V/H07V)	
Solid / stranded	mm ²
Flexible / flexible w. wire end ferrule	mm ²
Tightening torque range (clamping screw)	Nm
Stripping length / blade size	mm / -

2 clampable conductors of equal cross-section	
Solid / stranded	mm ²
Flexible / flexible w. wire end ferrule	mm ²

Information

Order data

Version	
	yellow
	blue

Information

Accessories

Cross-connection, screwable	
	2-pole
	3-pole
	4-pole
	10-pole
	Connecting sleeve
	Fixing screw
	Fuse cartridges

Cross-connection saddle	
	Cross-connection saddle
	Connecting sleeve
	Fixing screw

Socket / Test plug	
	Socket
	Test plug

End plate	
	yellow
	blue

Partition / Partition disc	
	dark brown
	for tropical applications
	Partition disc

Cover / fixing screw (plastic)	
	Cover
	Fixing screw (plastic)

Marking systems	
	DEK 6

Detailed information on all versions in chapter accessories.

IEC 60947-7-1 / IEC 60068-2-20

IEC	UL	CSA	EN 50019
250		300	
17.5		10	
1.5		AWG 26...12	
		4 / 3	
		/ 5VA	

Rated connection	Additional connection

IEC 60947-7-1 / IEC 60068-2-20 / VDE 0100-537

IEC	UL	CSA	EN 50019
250		300	
10		10	
1.5		AWG 22...12	
		4 / 3	
		/ 5VA	

Rated connection	Additional connection

Tightening torque for the test sockets 0.5 ... 0.7 Nm

Type	Qty.	Order No.
SAKR LL 2STB/KRG	100	0294220000

Type	Qty.	Order No.
SAK 2.5 LL KRG	100	0323620000
SAK 2.5 LL KRG/BL	100	0323670000

Type	Current [A]	Qty.	Order No.
Q 2 SAK2.5	41	50	0337000000
Q 3 SAK2.5	41	50	0337100000
Q 4 SAK2.5	41	50	0337200000
Q 10 SAK2.5	41	20	0368700000

Type	Current [A]	Qty.	Order No.
PS 2.3 RT		20	0180400000

	Width [mm]	
AP SAK2.5L KRG	1.5	20
AP SAK2.5L KRG BL	1.5	20

	Width [mm]	
AP SAKR BE	1.5	20
AP SAKR BL	1.5	20

	Width [mm]	
TW SAK2.5 HP/TF/GE/1		1 20
TSCH 1		2 100

	Width [mm]	
TW AST1/PA HP/DBR/0.5	0.5	20

AD 4 AKZ4		50
BFSC M3X22 PA/RT		100

DEK 6,5		

Bolt-type screw terminal - SAKG

TS 32 / KRG

SAKG 28 I

35 mm²

TS 32 / KRG

B

When using ATEX certified components in hazardous area applications the installation instructions and the rated data for accessories in the technical appendix must be considered.

Width/Length/Height with TS32	mm
Max. current / max. cond. cross-section	A/mm ²
Max. clamping range	mm ²

28 x 70 x 63.5
150 / 50
6 ... 50



The Weidmüller SAKG range offers the following connection variants:

- clamping yoke/flat lug as a combination, Version I.
- flat lug, Version II.
Two types of threading are provided here.
a) screw set with lock nut
b) with thread in busbar
- clamping yoke connection, Version III. The stripped conductor can be connected without further preparation.

Versions

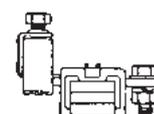

Version I



Version II
without thread

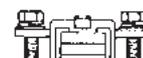

Version II G
with thread

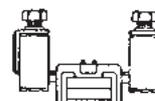

Version III

Cables with cable lugs are connected to SAKG terminals of Version I and to SS stud terminals.

Fitting instructions for SAKG terminals

When tightening the clamping screw, it is recommended that the conductor be held against the direction of tightening to prevent deformation of the mounting rail and so as not to place the terminal foot under undue torsional forces.

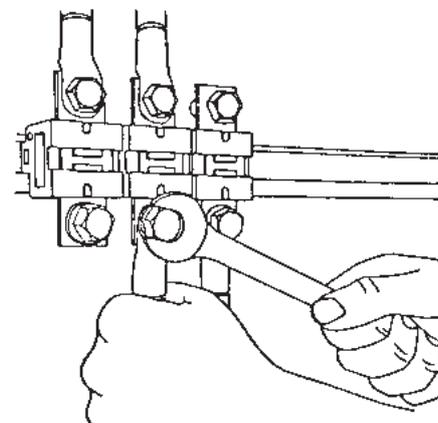

Cover

To ensure shock protection following connections of conductors, AH covers can be clipped onto the terminal.

Technical data

Rated data	
Rated voltage	V
Rated current	A
Rated cross-section	mm ²
Rated impulse voltage / Pollution severity	kV/-
Plug gauge IEC 60-947-1 / flammability class acc. UL 94	
Approvals	

IEC 60947-7-1

IEC	UL	CSA	EN 50019
1000	600	600	
125	95	110	
35	AWG 6...2	AWG 6...1	
		8 / 3	
		B9 / 5VA	



Clampable conductors (H05V/H07V)	
Solid / stranded	mm ²
Flexible / flexible w. wire end ferrule	mm ²
Tightening torque range (clamping screw)	Nm
Stripping length / blade size	mm / -

Rated connection	Additional connection
6...16 / 6...50	
10...35 / 6...35	
4.0...6.0 (M 6)	
15	

2 clampable conductors of equal cross-section	
Solid / stranded	mm ²
Flexible / flexible w. wire end ferrule	mm ²

Information

Order data

Version	yellow blue
----------------	----------------

Type	Qty.	Order No.
SAKG 28 I	10	0170020000

Information

Accessories

Cross-connection, screwable	
	2-pole
	3-pole
	4-pole
	10-pole
	Connecting sleeve
	Fixing screw
	Fuse cartridges

Type	Current [A]	Qty.	Order No.
QL 2 SAKG28		10	0551200000
QL 3 SAKG28		5	0407600000
QL 4 SAKG28		5	0407700000

Cross-connection saddle	
	Cross-connection saddle
	Connecting sleeve
	Fixing screw

Socket / Test plug	
	Socket
	Test plug

End plate	
	dark brown
	for tropical applications

Width [mm]			
EP 1 SAKG28/32 HP/DBR	2	10	0205100000
EP 1 SAKG28/32 HP/TF/GE	2	10	0205200000

Partition / Partition disc	
	dark brown
	for tropical applications
	Partition disc

Width [mm]			
TW SAKG28 HP/DBR/2	2	10	0151400000
TW SAKG28 HP/TF/GE/2	2	10	0164600000

Cover / fixing screw (plastic)	
	Cover
	Fixing screw (plastic)

AH 28 SAKG28	5	0326600000
--------------	---	------------

Marking systems	
------------------------	--

DEK 5

Detailed information on all versions in chapter accessories.	
---	--

Bolt-type screw terminal - SAKG

TS 32 / KRG

SAKG 28 II

35 mm²

SAKG 28 II G

35 mm²

When using ATEX certified components in hazardous area applications the installation instructions and the rated data for accessories in the technical appendix must be considered.

Width/Length/Height with TS32	mm
Max. current / max. cond. cross-section	A/mm ²
Max. clamping range	mm ²

28 x 70 x 53	
150 / 50	
6 ... 50	

28 x 70 x 51.4	
150 / 50	
6 ... 50	

Technical data

Rated data	
Rated voltage	V
Rated current	A
Rated cross-section	mm ²
Rated impulse voltage / Pollution severity	kV/-
Plug gauge IEC 60-947-1 / flammability class acc. UL 94	
Approvals	

IEC 60947-7-1

IEC	UL	CSA	EN 50019
1000	600	600	
125	115	110	
35	AWG 6...2	AWG 6...1	
		8 / 3	
		/ 5VA	

IEC 60947-7-1

IEC	UL	CSA	EN 50019
1000		600	
125		110	
35		AWG 6...1	
		8	
		/ 5VA	

Clampable conductors (H05V/H07V)	
Solid / stranded	mm ²
Flexible / flexible w. wire end ferrule	mm ²
Tightening torque range (clamping screw)	Nm
Stripping length / blade size	mm / -



Rated connection	Additional connection
3.0...6.0 (M 6)	



Rated connection	Additional connection
3.0...6.0 (M 6)	

2 clampable conductors of equal cross-section	
Solid / stranded	mm ²
Flexible / flexible w. wire end ferrule	mm ²

Information

Order data

Version	
	yellow
	blue

Type	Qty.	Order No.
SAKG 28 II	10	0170320000

Type	Qty.	Order No.
SAKG 28 II/GW	10	0185020000

Information

Accessories

Cross-connection, screwable	
	2-pole
	3-pole
	4-pole
	10-pole
	Connecting sleeve
	Fixing screw
	Fuse cartridges

Type	Current [A]	Qty.	Order No.
QL 2 SAKG28		10	0551200000
QL 3 SAKG28		5	0407600000
QL 4 SAKG28		5	0407700000

Type	Current [A]	Qty.	Order No.
QL 2 SAKG28		10	0551200000
QL 3 SAKG28		5	0407600000
QL 4 SAKG28		5	0407700000

Cross-connection saddle	
	Cross-connection saddle
	Connecting sleeve
	Fixing screw

Socket / Test plug	
	Socket
	Test plug

End plate	
	dark brown
	for tropical applications

Width [mm]			
EP 1 SAKG28/32 HP/DBR	2	10	0205100000
EP 1 SAKG28/32 HP/TF/GE	2	10	0205200000

Width [mm]			
EP 1 SAKG28/32 HP/DBR	2	10	0205100000
EP 1 SAKG28/32 HP/TF/GE	2	10	0205200000

Partition / Partition disc	
	dark brown
	for tropical applications
	Partition disc

Width [mm]			
TW SAKG28 HP/DBR/2	2	10	0151400000
TW SAKG28 HP/TF/GE/2	2	10	0164600000

Width [mm]			
TW SAKG28 HP/DBR/2	2	10	0151400000
TW SAKG28 HP/TF/GE/2	2	10	0164600000

Cover / fixing screw (plastic)	
	Cover
	Fixing screw (plastic)

AH 28 SAKG28	5	0326660000
--------------	---	------------

AH 28 SAKG28	5	0326660000
--------------	---	------------

Marking systems

DEK 5

DEK 5

Detailed information on all versions in chapter accessories.

TS 32 / KRG

B

Bolt-type screw terminal - SAKG

TS 32 / KRG

SAKG 28 III

35 mm²

SAKG 32 I

50 mm²

TS 32 / KRG

B

When using ATEX certified components in hazardous area applications the installation instructions and the rated data for accessories in the technical appendix must be considered.

Width/Length/Height with TS32	mm
Max. current / max. cond. cross-section	A/mm ²
Max. clamping range	mm ²

28 x 70 x 63.5	
150 / 50	
6 ... 50	

32 x 87 x 84	
192 / 70	
10 ... 70	

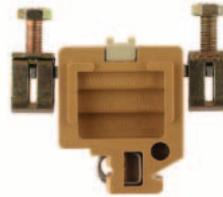

Technical data

Rated data	
Rated voltage	V
Rated current	A
Rated cross-section	mm ²
Rated impulse voltage / Pollution severity	kV/-
Plug gauge IEC 60-947-1 / flammability class acc. UL 94 Approvals	
Clampable conductors (H05V/H07V)	
Solid / stranded	mm ²
Flexible / flexible w. wire end ferrule	mm ²
Tightening torque range (clamping screw)	Nm
Stripping length / blade size	mm / -
2 clampable conductors of equal cross-section	
Solid / stranded	mm ²
Flexible / flexible w. wire end ferrule	mm ²
Information	

IEC 60947-7-1			
IEC	UL	CSA	EN 50019
1000	600	600	
125	95	135	
35	AWG 6...2	AWG 8...2	
8 / 3			
B9 / 5VA			
UL			
Rated connection	Additional connection		
6...16 / 6...50			
10...35 / 6...35			
4.0...6.0 (M 6)			
15			
Information			

IEC 60947-7-1			
IEC	UL	CSA	EN 50019
1000	600	600	
150	165	170	
50	AWG 6...3/0	AWG 1...2/0	
8 / 3			
B11 / 5VA			
UL			
Rated connection	Additional connection		
10...16 / 10...70			
10...70 / 10...35			
6.0...12 (M 8)			
26			
Information			

Order data

Version	Information
yellow	
blue	

Type	Qty.	Order No.
SAKG 28 III	10	0170820000
Information		

Type	Qty.	Order No.
SAKG 32 I	10	0286620000
Information		

Accessories

Cross-connection, screwable	
	2-pole
	3-pole
	4-pole
	10-pole
	Connecting sleeve
	Fixing screw
	Fuse cartridges
Cross-connection saddle	
	Cross-connection saddle
	Connecting sleeve
	Fixing screw
Socket / Test plug	
	Socket
	Test plug
End plate	
	dark brown
	for tropical applications
Partition / Partition disc	
	dark brown
	for tropical applications
	Partition disc
Cover / fixing screw (plastic)	
	Cover
	Fixing screw (plastic)
Marking systems	
	DEK 5
Detailed information on all versions in chapter accessories.	

Type	Current [A]	Qty.	Order No.
EP 1 SAKG28/32 HP/DBR	2	10	0205100000
EP 1 SAKG28/32 HP/TF/GE	2	10	0205200000
Width [mm]			
TW SAKG28 HP/DBR/2	2	10	0151400000
TW SAKG28 HP/TF/GE/2	2	10	0164600000
AH 28 SAKG28		5	0326660000
Information			
DEK 5			

Type	Current [A]	Qty.	Order No.
QL 2 SAKG32+70	150	5	0194000000
QL 3 SAKG32+70	150	5	0441500000
QL 4 SAKG32+70	150	5	0441600000
Width [mm]			
EP 2 SAKG46/32 HP/DBR	2	10	0205300000
EP 2 SAKG46/32 HP/TF/GE	2	10	0205400000
Width [mm]			
TW SAKG46 HP/DBR/2	2	10	0177100000
TW SAKG46 HP/TF/GE/2	2	10	0179900000
AH 32 SAKG32		5	0326760000
Information			
DEK 5			

Bolt-type screw terminal - SAKG

SAKG 32 II

50 mm²



32 x 80 x 53
192 / 70
10 ... 70



IEC 60947-7-1

IEC	UL	CSA	EN 50019
1000	600	600	
150	200	170	
50	AWG 6...3/0	AWG 1...2/0	
	8 / 3		
	/ 5VA		



Rated connection	Additional connection
6.0...12 (M 8)	

SAKG 32 II G

50 mm²



32 x 80 x 53
192 / 70
10 ... 70

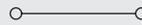

IEC 60947-7-1

IEC	UL	CSA	EN 50019
1000	600	600	
150	200	170	
50	AWG 6...3/0	AWG 1...2/0	
	8 / 3		
	/ 5VA		



Rated connection	Additional connection
6.0...12 (M 8)	

SAKG 32 III

50 mm²

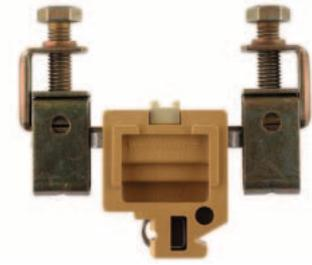

32 x 94 x 84.5
192 / 70
10 ... 70



IEC 60947-7-1

IEC	UL	CSA	EN 50019
1000	600	600	
150	165	185	
50	AWG 6...3/0	AWG 1...2/0	
	8 / 3		
	B11 / 5VA		



Rated connection	Additional connection
10...16 / 10...70	
10...70 / 10...35	
6.0...12 (M 8)	
26	

Type	Qty.	Order No.
SAKG 32 II	10	0170420000

Type	Qty.	Order No.
SAKG 32 II/GW	10	0185120000

Type	Qty.	Order No.
SAKG 32 III	10	0286720000

Type	Current [A]	Qty.	Order No.
QL 2 SAKG32+70	150	5	0194000000
QL 3 SAKG32+70	150	5	0441500000
QL 4 SAKG32+70	150	5	0441600000

Type	Current [A]	Qty.	Order No.
QL 2 SAKG32+70	150	5	0194000000
QL 3 SAKG32+70	150	5	0441500000
QL 4 SAKG32+70	150	5	0441600000

Type	Current [A]	Qty.	Order No.

Width [mm]			
EP 1 SAKG28/32 HP/DBR	2	10	0205100000
EP 1 SAKG28/32 HP/TF/GE	2	10	0205200000
Width [mm]			
TW SAKG46 HP/DBR/2	2	10	0177100000
TW SAKG46 HP/TF/GE/2	2	10	0179900000

Width [mm]			
EP 1 SAKG32/35 HP/DBR	2	10	0180500000
EP 1 SAKG32/35 HP/TF/GE	2	10	0180600000
Width [mm]			
TW SAKG28 HP/DBR/2	2	10	0151400000
TW SAKG28 HP/TF/GE/2	2	10	0164600000

Width [mm]			
EP 2 SAKG46/32 HP/DBR	2	10	0205300000
EP 2 SAKG46/32 HP/TF/GE	2	10	0205400000
Width [mm]			
TW SAKG46 HP/DBR/2	2	10	0177100000
TW SAKG46 HP/TF/GE/2	2	10	0179900000

AH 32 SAKG32	5	0326760000
--------------	---	------------

AH 32 SAKG32	5	0326760000
--------------	---	------------

AH 32 SAKG32	5	0326760000
--------------	---	------------

DEK 5

DEK 5

DEK 5

Bolt-type screw terminal - SAKG

TS 32 / KRG

SAKG 70 II G

70 mm²

SAKG 40 I

95 mm²

TS 32 / KRG

B

When using ATEX certified components in hazardous area applications the installation instructions and the rated data for accessories in the technical appendix must be considered.

Width/Length/Height with TS32	mm
Max. current / max. cond. cross-section	A/mm ²
Max. clamping range	mm ²

32 x 84 x 51.4	
192 / 95	
16 ... 95	

40 x 94 x 84.5	
232 / 95	
10 ... 95	

Technical data

Rated data	
Rated voltage	V
Rated current	A
Rated cross-section	mm ²
Rated impulse voltage / Pollution severity	kV/-
Plug gauge IEC 60-947-1 / flammability class acc. UL 94 Approvals	

IEC 60947-7-1

IEC	UL	CSA	EN 50019
1000		600	
192		200	
70		AWG 2/0...4/0	
		8 / 3	
		/ 5VA	

IEC 60947-7-1

IEC	UL	CSA	EN 50019
1000	600	600	
232	195	250	
95	...4/0	AWG 2/0...4/0	
		8 / 3	
		B12 / 5VA	

Clampable conductors (H05V/H07V)	
Solid / stranded	mm ²
Flexible / flexible w. wire end ferrule	mm ²
Tightening torque range (clamping screw)	Nm
Stripping length / blade size	mm / -

Rated connection	Additional connection
10...16 / 10...95	
10...95	
6.0...12 (M 8)	

Rated connection	Additional connection
10...16 / 10...95	
10...95 / 10...35	
10...20 (M 10)	
25	

2 clampable conductors of equal cross-section	
Solid / stranded	mm ²
Flexible / flexible w. wire end ferrule	mm ²

Information	

Order data

Version	
	yellow
	blue

Type	Qty.	Order No.
SAKG 70 II/GW	10	0150420000

Type	Qty.	Order No.
SAKG 40 I	10	0286820000

Information	

Accessories

Cross-connection, screwable	
	2-pole
	3-pole
	4-pole
	10-pole
	Connecting sleeve
	Fixing screw
	Fuse cartridges

Type	Current [A]	Qty.	Order No.
QL 2 SAKG32+70	150	5	0194000000
QL 3 SAKG32+70	150	5	0441500000
QL 4 SAKG32+70	150	5	0441600000

Type	Current [A]	Qty.	Order No.
QL 2 SAKG40	232	5	0194100000
QL 3 SAKG40	232	5	0263500000
QL 4 SAKG40	232	5	0409800000

Cross-connection saddle	
	Cross-connection saddle
	Connecting sleeve
	Fixing screw

Socket / Test plug	
	Socket
	Test plug

End plate	
	dark brown
	for tropical applications

Width [mm]			
EP 1 SAKG28/32 HP/DBR	2	10	0205100000
EP 1 SAKG28/32 HP/TF/GE	2	10	0205200000

Width [mm]			
EP 2 SAKG46/32 HP/DBR	2	10	0205300000
EP 2 SAKG46/32 HP/TF/GE	2	10	0205400000

Partition / Partition disc	
	dark brown
	for tropical applications
	Partition disc

Width [mm]			
TW SAKG28 HP/DBR/2	2	10	0151400000
TW SAKG28 HP/TF/GE/2	2	10	0164600000

Width [mm]			
TW SAKG46 HP/DBR/2	2	10	0177100000
TW SAKG46 HP/TF/GE/2	2	10	0179900000

Cover / fixing screw (plastic)	
	Cover
	Fixing screw (plastic)

AH 32 SAKG32	5	0326760000
--------------	---	------------

AH 40 SAKG40	5	0326860000
--------------	---	------------

Marking systems	
	DEK 5

DEK 5		
-------	--	--

DEK 5		
-------	--	--

Detailed information on all versions in chapter accessories.

Bolt-type screw terminal - SAKG

SAKG 40 II

95 mm²



40 x 90 x 53
232 / 95
10 ... 95



IEC 60947-7-1

IEC	UL	CSA	EN 50019
1000	600	600	
232	230	250	
95	...4/0	AWG 2/0...4/0	
	8 / 3		
	/ 5VA		



Rated connection	Additional connection
...16 / 10...95	
10...95	
10...20 (M 10)	

SAKG 40 II GW

95 mm²



40 x 90 x 53
232 / 95
10 ... 95

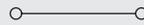

IEC 60947-7-1

IEC	UL	CSA	EN 50019
1000	600	600	
232	230	250	
95	...4/0	AWG 2/0...4/0	
	8 / 3		
	/ 5VA		



Rated connection	Additional connection
...16 / 10...95	
10...95	
10...20 (M 10)	

SAKG 40 III

95 mm²



40 x 98 x 84.5
232 / 95
10 ... 95

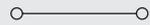

IEC 60947-7-1

IEC	UL	CSA	EN 50019
1000	600	600	
232	195	230	
95	...4/0	AWG 2/0...4/0	
	8 / 3		
	B12 / 5VA		



Rated connection	Additional connection
10...16 / 10...95	
10...95 / 10...95	
10...20 (M 10)	
25	

Type	Qty.	Order No.
SAKG 40 II	10	0170520000

Type	Qty.	Order No.
SAKG 40 II/GW	10	0185220000

Type	Qty.	Order No.
SAKG 40 III	10	0286920000

Type	Current [A]	Qty.	Order No.
QL 2 SAKG40	232	5	0194100000
QL 3 SAKG40	232	5	0263500000
QL 4 SAKG40	232	5	0409800000

Type	Current [A]	Qty.	Order No.
QL 2 SAKG40	232	5	0194100000
QL 3 SAKG40	232	5	0263500000
QL 4 SAKG40	232	5	0409800000

Type	Current [A]	Qty.	Order No.

Width [mm]			
EP 2 SAKG46/32 HP/DBR	2	10	0205300000
EP 2 SAKG46/32 HP/TF/GE	2	10	0205400000

Width [mm]			
EP 2 SAKG46/32 HP/DBR	2	10	0205300000
EP 2 SAKG46/32 HP/TF/GE	2	10	0205400000

Width [mm]			
EP 2 SAKG46/32 HP/DBR	2	10	0205300000
EP 2 SAKG46/32 HP/TF/GE	2	10	0205400000

Width [mm]			
TW SAKG46 HP/DBR/2	2	10	0177100000
TW SAKG46 HP/TF/GE/2	2	10	0179900000

Width [mm]			
TW SAKG46 HP/DBR/2	2	10	0177100000
TW SAKG46 HP/TF/GE/2	2	10	0179900000

Width [mm]			
TW SAKG46 HP/DBR/2	2	10	0177100000
TW SAKG46 HP/TF/GE/2	2	10	0179900000

AH 40 SAKG40	5	0326860000
--------------	---	------------

AH 40 SAKG40	5	0326860000
--------------	---	------------

AH 40 SAKG40	5	0326860000
--------------	---	------------

DEK 5

DEK 5

DEK 5

Bolt-type screw terminal - SAKG

TS 32 / KRG

SAKG 46 II

150 mm²

SAKG 46 II GW

150 mm²

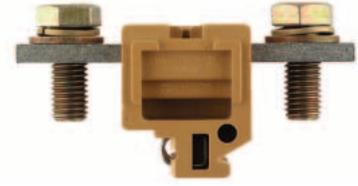

When using ATEX certified components in hazardous area applications the installation instructions and the rated data for accessories in the technical appendix must be considered.

Width/Length/Height with TS32	mm
Max. current / max. cond. cross-section	A/mm ²
Max. clamping range	mm ²

46 x 106 x 57	
309 / 150	
16 ... 150	

46 x 106 x 57	
309 / 150	
16 ... 150	

Technical data

Rated data	
Rated voltage	V
Rated current	A
Rated cross-section	mm ²
Rated impulse voltage / Pollution severity	kV/-
Plug gauge IEC 60-947-1 / flammability class acc. UL 94	
Approvals	

IEC 60947-7-1

IEC	UL	CSA	EN 50019
1000	600	600	
309	285	365	
150	AWG 4/0...300	kcmil 300	
		8 / 3	
		/ 5VA	

IEC 60947-7-1

IEC	UL	CSA	EN 50019
1000	600	600	
309	285	365	
150	AWG 4/0...300	kcmil 300	
		8 / 3	
		/ 5VA	

Clampable conductors (H05V/H07V)	
Solid / stranded	mm ²
Flexible / flexible w. wire end ferrule	mm ²
Tightening torque range (clamping screw)	Nm
Stripping length / blade size	mm / -

Rated connection	Additional connection
10...16 / 10...150	
10...150	
14...31 (M 12)	

Rated connection	Additional connection
10...16 / 10...150	
10...150	
14...31 (M 12)	

2 clampable conductors of equal cross-section	
Solid / stranded	mm ²
Flexible / flexible w. wire end ferrule	mm ²

Information	

Order data

Version	
	yellow
	blue

Type	Qty.	Order No.
SAKG 46 II	5	0170620000

Type	Qty.	Order No.
SAKG 46 II/GW	5	0185320000

Information	

Accessories

Cross-connection, screwable	
	2-pole
	3-pole
	4-pole
	10-pole
	Connecting sleeve
	Fixing screw
	Fuse cartridges

Type	Current [A]	Qty.	Order No.
QL 2 SAKG46	309	5	0247000000
QL 3 SAKG46	309	5	0444400000
QL 4 SAKG46	309	5	0444500000

Type	Current [A]	Qty.	Order No.
QL 2 SAKG46	309	5	0247000000
QL 3 SAKG46	309	5	0444400000
QL 4 SAKG46	309	5	0444500000

Cross-connection saddle	
	Cross-connection saddle
	Connecting sleeve
	Fixing screw

Socket / Test plug	
	Socket
	Test plug

End plate	
	dark brown
	for tropical applications

Width [mm]			
EP 2 SAKG46/32 HP/DBR	2	10	0205300000
EP 2 SAKG46/32 HP/TF/GE	2	10	0205400000

Width [mm]			
EP 2 SAKG46/32 HP/DBR	2	10	0205300000
EP 2 SAKG46/32 HP/TF/GE	2	10	0205400000

Partition / Partition disc	
	dark brown
	for tropical applications
	Partition disc

Width [mm]			
TW SAKG46 HP/DBR/2	2	10	0177100000
TW SAKG46 HP/TF/GE/2	2	10	0179900000

Width [mm]			
TW SAKG46 HP/DBR/2	2	10	0177100000
TW SAKG46 HP/TF/GE/2	2	10	0179900000

Cover / fixing screw (plastic)	
	Cover
	Fixing screw (plastic)

AH 46 SAKG46	5	0326960000
--------------	---	------------

AH 46 SAKG46	5	0326960000
--------------	---	------------

Marking systems	
	DEK 5

DEK 5		
-------	--	--

DEK 5		
-------	--	--

Detailed information on all versions in chapter accessories.

Bolt-type screw terminal - SAKG

SAKG 46/AL

150 mm²

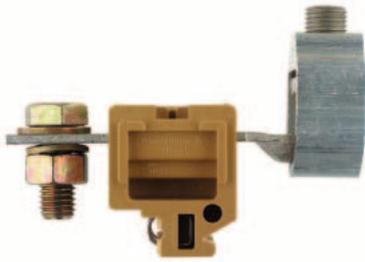

46 x 109 x 74
353 / 240
35 ... 240



IEC 60947-7-1

IEC	UL	CSA	EN 50019
1000			
269			
150			
	8 / 3		
	/ 5VA		

Rated connection	Additional connection
50...240 / 35...185	
50...240	
14...31 (M 12)	
23	

Type	Qty.	Order No.
SAKG 46 I/AL	5	1287920000

Type	Current [A]	Qty.	Order No.
QL 2 SAKG32+70	150	5	0194000000
QL 3 SAKG32+70	150	5	0441500000
QL 4 SAKG32+70	150	5	0441600000

Width [mm]			
EP 2 SAKG46/32 HP/DBR	2	10	0205300000
EP 2 SAKG46/32 HP/TF/GE	2	10	0205400000

Width [mm]			
TW SAKG46 HP/DBR/2	2	10	0177100000
TW SAKG46 HP/TF/GE/2	2	10	0179900000

AH 46 SAKG46	5	0326960000
--------------	---	------------

DEK 5

SAKG 54 II

240 mm²



54 x 122 x 60,5
415 / 240
70 ... 240

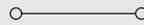

IEC 60947-7-1

IEC	UL	CSA	EN 50019
1000	600	600	
415	380	600	
240	...500	kcmil 300...500	
	8 / 3		
	/ 5VA		



Rated connection	Additional connection
25...60 (M 16)	

Type	Qty.	Order No.
SAKG 54 II	5	0170720000

Type	Current [A]	Qty.	Order No.
QL 2 SAKG54	415	5	0264400000
QL 3 SAKG54	415	5	0408000000
QL 4 SAKG54	415	5	0247400000

Width [mm]			
EP 2 SAKG46/32 HP/DBR	2	10	0205300000
EP 2 SAKG46/32 HP/TF/GE	2	10	0205400000

Width [mm]			
TW SAKG46 HP/DBR/2	2	10	0177100000
TW SAKG46 HP/TF/GE/2	2	10	0179900000

DEK 5

SAKG 54 II GW

240 mm²



54 x 122 x 60,5
415 / 240
70 ... 240

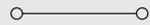

IEC 60947-7-1

IEC	UL	CSA	EN 50019
1000	600	600	
415	380	600	
240	...500	kcmil 300...500	
	8 / 3		
	/ 5VA		



Rated connection	Additional connection
25...60 (M 16)	

Type	Qty.	Order No.
SAKG 54 II/GW	5	0185420000

Type	Current [A]	Qty.	Order No.
QL 2 SAKG54	415	5	0264400000
QL 3 SAKG54	415	5	0408000000
QL 4 SAKG54	415	5	0247400000

Width [mm]			
EP 2 SAKG46/32 HP/DBR	2	10	0205300000
EP 2 SAKG46/32 HP/TF/GE	2	10	0205400000

Width [mm]			
TW SAKG46 HP/DBR/2	2	10	0177100000
TW SAKG46 HP/TF/GE/2	2	10	0179900000

DEK 5

Stud terminal - KST

TS 32 / PA

KST 5

10 mm²

KST 6

16 mm²

TS 32 / PA

B

When using ATEX certified components in hazardous area applications the installation instructions and the rated data for accessories in the technical appendix must be considered.

Width/Length/Height with TS35x7.5 mm
 Max. current / max. cond. cross-section A/mm²
 Max. clamping range mm²

24 x 60 x 55
57 / 10

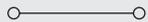
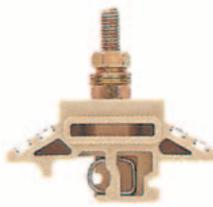

22 x 60 x 60
76 / 16

Technical data

Rated data w. partition, Wemid	
Rated voltage	V
Rated current	A
Rated cross-section	mm ²
Rated impulse voltage / Pollution severity	kV/-
Plug gauge IEC 60-947-1 / flammability class acc. UL 94	
Approvals	

Rated data w. partition, Epoxy resin	
Rated voltage / Rated impulse voltage	V/kV

Clamped cable lug	
DIN 46234 / 1 cable lug per side	mm ²
DIN 46234 / 2 cable lug per side	mm ²
DIN 46234 / 1 cable lug per side	mm ²
DIN 46234 / 2 cable lug per side	mm ²
Tightening torque range	Nm

Information

IEC	UL	CSA	EN 50019
1000	600	600	
57	50	65	
10	AWG 12...6	AWG 8...2	
	8 / 3		
	/ V2		



EN 50124

IEC	UL	CSA	EN 50019
1000	600	600	
76	65	80	
16	AWG 12...6	AWG 12...6	
	8 / 3		
	/ V2		



EN 50124

Order data

Version
TS 35 x 7.5 TS 35 x 15/2.3

Information

Type	Height	Qty.	Order No.
KST 5/32 M5X18	55	25	9503370000

Type	Height	Qty.	Order No.
KST 6/32 M6X22	60	25	9501310000

Accessories

Cross-connection
2-pole 3-pole

Partition
right left

Type	Current [A]	Qty.	Order No.
W/L/H TS 35 [mm]			
TW KST5-12 RE/NO 160/HM		10	1718530000
TW KST5-12 LI/NO 160/HM		10	1752800000

Type	Current [A]	Qty.	Order No.
QL 2 KST6		5	9501350000
W/L/H TS 35 [mm]			
TW KST5-12 RE/NO 160/HM		10	1718530000
TW KST5-12 LI/NO 160/HM		10	1752800000

Marking systems

DEK 5

For detailed information on other accessories and applications see "Accessories"

Stud terminal - KST

KST 8

35 mm²

KST 10

70 mm²

KST 12

95 mm²



24 x 60 x 72
125 / 35

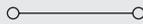

34 x 60 x 82
192 / 70



34 x 60 x 82
232 / 95

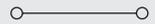

IEC	UL	CSA	EN 50019
1000	600	600	
125	115	130	
35	AWG 12... 2	AWG 12... 2	
	8 / 3		
	/ V2		



EN 50124

IEC	UL	CSA	EN 50019
1000	600	600	
192	175	200	
70	AWG 12... 2/0	AWG 12... 2/0	
	8 / 3		
	/ V2		



EN 50124

IEC	UL	CSA	EN 50019
1000	600	600	
232	200	250	
95	AWG 12... 3	AWG 12... 3/0	
	8 / 3		
	/ V2		



EN 50124

6.0...12

10...20

14...31

Type	Height	Qty.	Order No.
KST 8/32 M8X30	72	25	9501320000

Type	Height	Qty.	Order No.
KST 10/32 M10X39	82	20	9501330000

Type	Height	Qty.	Order No.
KST 12/32 M12X37	82	20	9501340000

Type	Current [A]	Qty.	Order No.
QL 2 KST8		5	9501360000

Type	Current [A]	Qty.	Order No.
QL 2 KST10		5	9501370000

Type	Current [A]	Qty.	Order No.
QL 2 KST12		5	9501380000

W/L/H TS 35 [mm]			
TW KST5-12 RE/NO 160/HM	10		1718530000
TW KST5-12 LI/NO 160/HM	10		1752800000

W/L/H TS 35 [mm]			
TW KST5-12 RE/NO 160/HM	10		1718530000
TW KST5-12 LI/NO 160/HM	10		1752800000

W/L/H TS 35 [mm]			
TW KST5-12 RE/NO 160/HM	10		1718530000
TW KST5-12 LI/NO 160/HM	10		1752800000

DEK 5

DEK 5

Modular terminals with electronic components

With electronic components TS 32 / PA

When using ATEX certified components in hazardous area applications the installation instructions and the rated data for accessories in the technical appendix must be considered.

Width/Length/Height with TS32	mm
Max. current / max. cond. cross-section	A/mm ²
Max. clamping range	mm ²

B

Technical data

Rated data	
Rated voltage	V
Rated current	A
Rated cross-section	mm ²
Rated impulse voltage / Pollution severity	kV/-
Plug gauge IEC 60-947-1 / flammability class acc. UL 94	
Approvals	
Electronic built-in components	
Diode current / diode voltage	V / A
voltage LED / current LED / polarity	V / mA / -
Resistance / Varistor	-/N
Clampable conductors (H05V/H07V)	
Solid / stranded	mm ²
Flexible / flexible w. wire end ferrule	mm ²
Tightening torque range (clamping screw)	Nm
Stripping length / blade size	mm / -
Information	

Order data

Version	
Terminal components	LED red
see circuit diagram above	LED green
	Neon lamp
	Neon lamp
Information	

Accessories

Cross-connection, screwable	
	2-pole
	3-pole
	4-pole
(Q)	10-pole
External cross-connection	
	2-pole
	3-pole
	4-pole
End plate	
	beige
Socket	
Test plug	
Connecting sleeve	
Cross-connection saddle	
Fixing screw / Partition disc	
	Fixing screw
	Partition disc
Marking systems	
For detailed information on other accessories and applications see "Accessories"	

DK 4 LD/1

4 mm²

DC voltage indicator

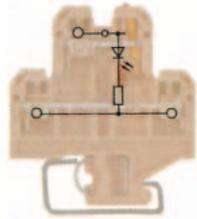

6 x 50 x 56.5
10 / 4
0.33 ... 4

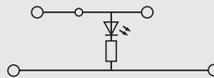

IEC 60947-7-1

IEC	UL	CSA	EN 50019
24			
10			
4			
	1 / 3		
	A3 / V2		
24 / 5			

Rated connection	Additional connection
0.5...4 / 0.5...4	
0.5...4 / 0.5...4	
0.5...1.0 (M3)	
	/ 3.5 x 0.6

Type	Spannung	Qty.	Order No.
DK 4/32 LD ROT 24VDC A1	24 VDC	25	0495360000
DK 4/32 LD GR 24VDC CSA	24 VDC	25	0686360000

DK 4 LD/2

4 mm²

DC voltage indicator

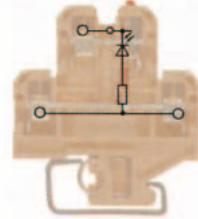

6 x 50 x 56.5
10 / 4
0.33 ... 4

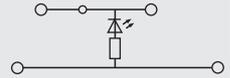

IEC 60947-7-1

IEC	UL	CSA	EN 50019
24			
10			
4			
	1 / 3		
	A3 / V2		
24 / 5			

Rated connection	Additional connection
0.5...4 / 0.5...4	
0.5...4 / 0.5...4	
0.5...1.0 (M3)	
	/ 3.5 x 0.6

Type	Spannung	Qty.	Order No.
DK 4/32 LD ROT 24VDC A2	24 VDC	25	0474460000
DK 4/32 LD GR 24VDC A2	24 VDC	25	0646560000

Type	Current [A]	Qty.	Order No.
Q 2 AKZ4	32	50	0336400000
Q 3 AKZ4	32	50	0336500000
Q 4 AKZ4	32	50	0336600000
Current [A]			
QB 2 WI RA6 IS	27	50	0482700000
QB 3 WI RA6 IS	27	50	0482800000
QB 4 WI RA6 IS	27	50	0482900000
AP DK4		20	0359260000
STB 8.5/D4/2.3/M2.5 AKZ		50	0215700000
PS 2.3 RT		20	0180400000
VH 10/4/2.8 AKZ4		50	0446600000
VL 2 AKZ4/DK4		50	0446700000
BFSC M2.5X14 SAKD2.5N		100	0266800000
TSCH 4 AKZ4		100	0363360000
DEK 6			

Modular terminals with electronic components

DK 4 LD/3

4 mm²

DC voltage indicator

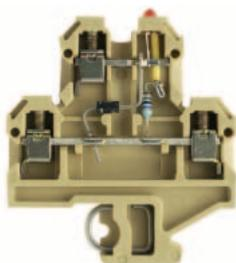

6 x 50 x 56.5
10 / 4
0.33 ... 4

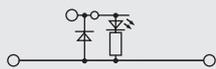

IEC 60947-7-1

IEC	UL	CSA	EN 50019
24			
10			
4			

1 / 3
A3 / V2



24 / 5

Rated connection **Additional connection**

0.5...4 / 0.5...4
0.5...4 / 0.5...4
0.5...1.0 (M3)
9 / 3.5 x 0.6

Type	Spannung	Qty.	Order No.
DK 4/32 LD ROT 24VDC	24 VDC	25	0210160000
DK 4/32 LD 1D GR 24VDC	24 VDC	25	0210360000

Type	Current [A]	Qty.	Order No.
Q 2 AKZ4	32	50	0336400000
Q 3 AKZ4	32	50	0336500000
Q 4 AKZ4	32	50	0336600000

	Current [A]	Qty.	Order No.
QB 2 WI RA6 IS	27	50	0482700000
QB 3 WI RA6 IS	27	50	0482800000
QB 4 WI RA6 IS	27	50	0482900000

AP DK4 20 **0359260000**

STB 8.5/D4/2.3/M2.5 AKZ 50 **0215700000**

PS 2.3 RT 20 **0180400000**

VH 10/4/2.8 AKZ4 50 **0446600000**

VL 2 AKZ4/DK4 50 **0446700000**

BFSC M2.5X14 SAKD2.5N 100 **0266800000**

TSCH 4 AKZ4 100 **0363360000**

DEK 6

DK 4 LD/4

4 mm²

DC voltage indicator

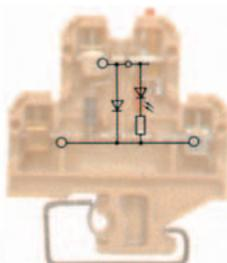

6 x 50 x 56.5
10 / 4
0.33 ... 4

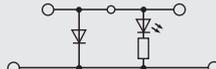

IEC 60947-7-1

IEC	UL	CSA	EN 50019
24			
10			
4			

1 / 3
A3 / V2



24 / 5

Rated connection **Additional connection**

0.5...4 / 0.5...4
0.5...4 / 0.5...4
0.5...1.0 (M3)
9 / 3.5 x 0.6

Type	Spannung	Qty.	Order No.
DK 4/32 LD 1D ROT 24VDC	24 VDC	25	0209760000
DK 4/32 LD 1D GR 24VDC	24 VDC	25	0209960000

Type	Current [A]	Qty.	Order No.
Q 2 AKZ4	32	50	0336400000
Q 3 AKZ4	32	50	0336500000
Q 4 AKZ4	32	50	0336600000

	Current [A]	Qty.	Order No.
QB 2 WI RA6 IS	27	50	0482700000
QB 3 WI RA6 IS	27	50	0482800000
QB 4 WI RA6 IS	27	50	0482900000

AP DK4 20 **0359260000**

STB 8.5/D4/2.3/M2.5 AKZ 50 **0215700000**

PS 2.3 RT 20 **0180400000**

VH 10/4/2.8 AKZ4 50 **0446600000**

VL 2 AKZ4/DK4 50 **0446700000**

BFSC M2.5X14 SAKD2.5N 100 **0266800000**

TSCH 4 AKZ4 100 **0363360000**

DEK 6

DK 4 LD/5

4 mm²

AC voltage indicator

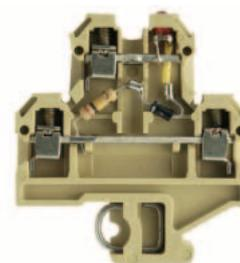

6 x 50 x 56.5
10 / 4
0.33 ... 4

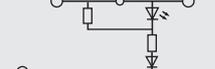

IEC 60947-7-1

IEC	UL	CSA	EN 50019
48			
10			
4			

1 / 3
A3 / V2



48 / 5

Rated connection **Additional connection**

0.5...4 / 0.5...4
0.5...4 / 0.5...4
0.5...1.0 (M3)
9 / 3.5 x 0.6

Type	Spannung	Qty.	Order No.
DK 4/32 LD 1D 230VAC	230 VAC	25	1111460000
DK 4/32 LD 1D 48VAC CSA	48 VAC	25	0632860000

Type	Current [A]	Qty.	Order No.
Q 2 AKZ4	32	50	0336400000
Q 3 AKZ4	32	50	0336500000
Q 4 AKZ4	32	50	0336600000

	Current [A]	Qty.	Order No.
QB 2 WI RA6 IS	27	50	0482700000
QB 3 WI RA6 IS	27	50	0482800000
QB 4 WI RA6 IS	27	50	0482900000

AP DK4 20 **0359260000**

STB 8.5/D4/2.3/M2.5 AKZ 50 **0215700000**

PS 2.3 RT 20 **0180400000**

VH 10/4/2.8 AKZ4 50 **0446600000**

VL 2 AKZ4/DK4 50 **0446700000**

BFSC M2.5X14 SAKD2.5N 100 **0266800000**

TSCH 4 AKZ4 100 **0363360000**

DEK 6

Modular terminals with electronic components

With electronic components TS 32 / PA

When using ATEX certified components in hazardous area applications the installation instructions and the rated data for accessories in the technical appendix must be considered.

Width/Length/Height with TS32	mm
Max. current / max. cond. cross-section	A/mm ²
Max. clamping range	mm ²

Technical data

Rated data	
Rated voltage	V
Rated current	A
Rated cross-section	mm ²
Rated impulse voltage / Pollution severity	kV/-
Plug gauge IEC 60-947-1 / flammability class acc. UL 94	
Approvals	
Electronic built-in components	
Diode current / diode voltage	V / A
voltage LED / current LED / polarity	V / mA / -
Resistance / Varistor	-/N
Clampable conductors (H05V/H07V)	
Solid / stranded	mm ²
Flexible / flexible w. wire end ferrule	mm ²
Tightening torque range (clamping screw)	Nm
Stripping length / blade size	mm / -
Information	

Order data

Version	
Terminal components	LED red
see circuit diagram above	LED green
	Neon lamp
	Neon lamp
Information	

Accessories

Cross-connection, screwable	
	2-pole
	3-pole
	4-pole
	10-pole
External cross-connection	
	2-pole
	3-pole
	4-pole
End plate	
	beige
Socket	
Test plug	
Connecting sleeve	
Cross-connection saddle	
Fixing screw / Partition disc	
	Fixing screw
	Partition disc
Marking systems	
For detailed information on other accessories and applications see "Accessories"	

DK 4 LD I

4 mm²

Current direction indicator

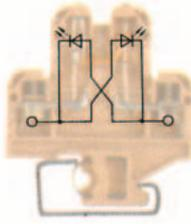

6 x 50 x 53.5
10 / 4
0.33 ... 4

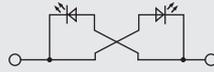

IEC	UL	CSA	EN 50019
250			
10			
4			
		/ 3	
		A3 / V2	

Rated connection	Additional connection
0.5...4 / 0.5...4	
0.5...4 / 0.5...4	
0.5...1.0 (M3)	
9 / 3.5 x 0.6	

Type	Spannung	Qty.	Order No.
DK 4/32 2LD I20MA	250 VAC	25	1164760000

Type	Current [A]	Qty.	Order No.
Q 2 AKZ4	32	50	0336400000
Q 3 AKZ4	32	50	0336500000
Q 4 AKZ4	32	50	0336600000

	Current [A]		
QB 2 WI RA6 IS	27	50	0482700000
QB 3 WI RA6 IS	27	50	0482800000
QB 4 WI RA6 IS	27	50	0482900000

AP DK4	20	0359260000
--------	----	------------

STB 8.5/D4/2.3/M2.5 AKZ	50	0215700000
-------------------------	----	------------

PS 2.3 RT	20	0180400000
-----------	----	------------

VH 10/4/2.8 AKZ4	50	0446600000
------------------	----	------------

VL 2 AKZ4/DK4	50	0446700000
---------------	----	------------

BFSC M2.5X14 SAKD2.5N	100	0266800000
-----------------------	-----	------------

TSCH 4 AKZ4	100	0363360000
-------------	-----	------------

DEK 6		
-------	--	--

DK 4 GL

4 mm²

AC voltage indicator

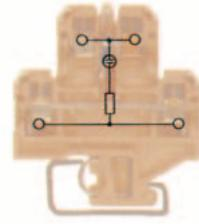

6 x 50 x 56.5
10 / 4
0.33 ... 4

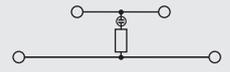

IEC	UL	CSA	EN 50019
230			
10			
4			
		1 / 3	
		A3 / V2	

Rated connection	Additional connection
0.5...4 / 0.5...4	
0.5...4 / 0.5...4	
0.5...1.0 (M3)	
9 / 3.5 x 0.6	

Type	Spannung	Qty.	Order No.
DK 4/32 GL 330K 230VAC	230 VAC	25	0509560000
DK 4/32 GL 100K 115VAC	115 VAC	25	0569560000

Type	Current [A]	Qty.	Order No.
Q 2 AKZ4	32	50	0336400000
Q 3 AKZ4	32	50	0336500000
Q 4 AKZ4	32	50	0336600000

	Current [A]		
QB 2 WI RA6 IS	27	50	0482700000
QB 3 WI RA6 IS	27	50	0482800000
QB 4 WI RA6 IS	27	50	0482900000

AP DK4	20	0359260000
--------	----	------------

STB 8.5/D4/2.3/M2.5 AKZ	50	0215700000
-------------------------	----	------------

PS 2.3 RT	20	0180400000
-----------	----	------------

VH 10/4/2.8 AKZ4	50	0446600000
------------------	----	------------

VL 2 AKZ4/DK4	50	0446700000
---------------	----	------------

BFSC M2.5X14 SAKD2.5N	100	0266800000
-----------------------	-----	------------

TSCH 4 AKZ4	100	0363360000
-------------	-----	------------

DEK 6		
-------	--	--

Modular terminals with electronic components

With electronic components TS 32 / PA

When using ATEX certified components in hazardous area applications the installation instructions and the rated data for accessories in the technical appendix must be considered.

Width/Length/Height with TS32	mm
Max. current / max. cond. cross-section	A/mm ²
Max. clamping range	mm ²

Technical data

Rated data	
Rated voltage	V
Rated current	A
Rated cross-section	mm ²
Rated impulse voltage / Pollution severity	kV/-
Plug gauge IEC 60-947-1 / flammability class acc. UL 94	
Approvals	
Electronic built-in components	
Diode current / diode voltage	V / A
voltage LED / current LED / polarity	V / mA / -
Resistance / Varistor	-/V
Clampable conductors (H05V/H07V)	
Solid / stranded	mm ²
Flexible / flexible w. wire end ferrule	mm ²
Tightening torque range (clamping screw)	Nm
Stripping length / blade size	mm / -
Information	

Order data

Version	
Terminal components	LED red
see circuit diagram above	LED green
	Neon lamp
	Neon lamp
Information	

Accessories

Cross-connection, screwable	
	(Q)
2-pole	
3-pole	
4-pole	
10-pole	
External cross-connection	
2-pole	
3-pole	
4-pole	
End plate	
	beige
Socket	
Test plug	
Connecting sleeve	
Cross-connection saddle	
Fixing screw / Partition disc	
Fixing screw	
Partition disc	
Marking systems	
For detailed information on other accessories and applications see "Accessories"	

DK 4 D/1

4 mm²

Diode terminal, e.g. as protection against polarity reversal

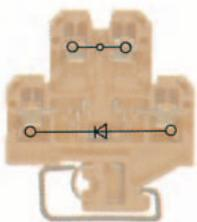

6 x 50 x 56.5	
10 / 4	
0.33 ... 4	

IEC	UL	CSA	EN 50019
380		380	
10	1	1	
4		AWG 22... 12	
		/ 3	
		A3 / V2	
			
1000 / 1			
		/ 1000	
Rated connection	Additional connection		
0.5...4 / 0.5...4			
0.5...4 / 0.5...4			
0.5...0.8 (M 3)			
9 / 3.5 x 0.6			
Information			

Type	Spannung	Qty.	Order No.
DK 4/32 1D CSA GET.SCH.	380 V	25	0544660000
Information			

Type	Current [A]	Qty.	Order No.
Q 2 AKZ4	32	50	0336400000
Q 3 AKZ4	32	50	0336500000
Q 4 AKZ4	32	50	0336600000
Current [A]			
QB 2 WI RA6 IS	27	50	0482700000
QB 3 WI RA6 IS	27	50	0482800000
QB 4 WI RA6 IS	27	50	0482900000
AP DK4		20	0359260000
STB 8.5/D4/2.3/M2.5 AKZ		50	0215700000
PS 2.3 RT		20	0180400000
VH 10/4/2.8 AKZ4		50	0446600000
VL 2 AKZ4/DK4		50	0446700000
BFSC M2.5X14 SAKD2.5N		100	0266800000
TSCH 4 AKZ4		100	0363360000
DEK 6			
Information			

DK 4 D/2

4 mm²

suppressor circuit for relay and magnetic valve (DC)

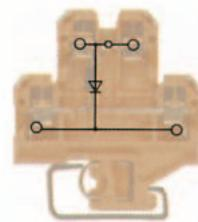

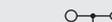
6 x 50 x 56.5	
10 / 4	
0.33 ... 4	

IEC	UL	CSA	EN 50019
380		380	
10	1	1	
4		AWG 22... 12	
		/ 3	
		A3 / V2	
			
1000 / 1			
		/ 1000	
Rated connection	Additional connection		
0.5...4 / 0.5...4			
0.5...4 / 0.5...4			
0.5...0.8 (M 3)			
9 / 3.5 x 0.6			
Information			

Type	Spannung	Qty.	Order No.
DK 4/32 1D CSA A1	380 V	25	0484060000
DK 4/32 1D CSA A1	380 V	25	0484080000
Information			

Type	Current [A]	Qty.	Order No.
Q 2 AKZ4	32	50	0336400000
Q 3 AKZ4	32	50	0336500000
Q 4 AKZ4	32	50	0336600000
Current [A]			
QB 2 WI RA6 IS	27	50	0482700000
QB 3 WI RA6 IS	27	50	0482800000
QB 4 WI RA6 IS	27	50	0482900000
AP DK4		20	0359260000
STB 8.5/D4/2.3/M2.5 AKZ		50	0215700000
PS 2.3 RT		20	0180400000
VH 10/4/2.8 AKZ4		50	0446600000
VL 2 AKZ4/DK4		50	0446700000
BFSC M2.5X14 SAKD2.5N		100	0266800000
TSCH 4 AKZ4		100	0363360000
DEK 6			
Information			

Modular terminals with electronic components

With electronic components TS 32 / PA

When using ATEX certified components in hazardous area applications the installation instructions and the rated data for accessories in the technical appendix must be considered.

Width/Length/Height with TS32	mm
Max. current / max. cond. cross-section	A/mm ²
Max. clamping range	mm ²

B

Technical data

Rated data	
Rated voltage	V
Rated current	A
Rated cross-section	mm ²
Rated impulse voltage / Pollution severity	kV/-
Plug gauge IEC 60-947-1 / flammability class acc. UL 94	
Approvals	

Electronic built-in components	
Diode current / diode voltage	V / A
voltage LED / current LED / polarity	V / mA / -
Resistance / Varistor	-/V

Clampable conductors (H05V/H07V)	
Solid / stranded	mm ²
Flexible / flexible w. wire end ferrule	mm ²
Tightening torque range (clamping screw)	Nm
Stripping length / blade size	mm / -

Information

Order data

Version	
Terminal components	LED red
see circuit diagram above	LED green
	Neon lamp
	Neon lamp

Information

Accessories

Cross-connection, screwable	
	2-pole
	3-pole
	4-pole
	10-pole

External cross-connection	
	2-pole
	3-pole
	4-pole

End plate	
	beige

Socket	

Test plug	

Connecting sleeve	

Cross-connection saddle	

Fixing screw / Partition disc	
Fixing screw	
Partition disc	

Marking systems	

For detailed information on other accessories and applications see "Accessories"

DK 4 D/3

4 mm²

suppressor circuit for relay and magnetic valve (DC)

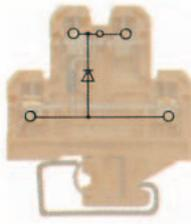

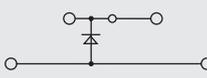
6 x 50 x 56.5	
10 / 4	
0.33 ... 4	

IEC	UL	CSA	EN 50019
380			
10			
4			
		/ 3	
		A3 / V2	

Rated connection		Additional connection	
1000 / 1			
		/ 1000	

Rated connection	Additional connection
0.5...4 / 0.5...4	
0.5...4 / 0.5...4	
0.5...0.8 (M 3)	
9 / 3.5 x 0.6	

Information

Type	Spannung	Qty.	Order No.
DK 4/32 1D CSA A2	380 V	25	0467960000
DK 4/32 1D CSA A2	380 V	25	0467980000

Information

Type	Current [A]	Qty.	Order No.
Q 2 AKZ4	32	50	0336400000
Q 3 AKZ4	32	50	0336500000
Q 4 AKZ4	32	50	0336600000

Current [A]			
QB 2 WI RA6 IS	27	50	0482700000
QB 3 WI RA6 IS	27	50	0482800000
QB 4 WI RA6 IS	27	50	0482900000

Current [A]			
AP DK4		20	0359260000

Current [A]			
STB 8.5/D4/2.3/M2.5 AKZ		50	0215700000

Current [A]			
PS 2.3 RT		20	0180400000

Current [A]			
VH 10/4/2.8 AKZ4		50	0446600000

Current [A]			
VL 2 AKZ4/DK4		50	0446700000

Type	Current [A]	Qty.	Order No.
BFSC M2.5X14 SAKD2.5N		100	0266800000
TSCH 4 AKZ4		100	0363360000

Current [A]			
DEK 6			

DK 4 D/4

4 mm²

Diodes terminal for lamp-test-circuits

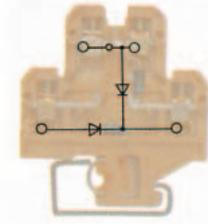

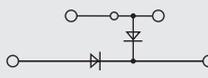
6 x 50 x 56.5	
10 / 4	
0.33 ... 4	

IEC	UL	CSA	EN 50019
380			
10			
4			
		/ 3	
		A3 / V2	

Rated connection		Additional connection	
1000 / 1			
		/ 1000	

Rated connection	Additional connection
0.5...4 / 0.5...4	
0.5...4 / 0.5...4	
0.5...0.8 (M 3)	
9 / 3.5 x 0.6	

Information

Type	Spannung	Qty.	Order No.
DK 4/32 2D CSA GET.SCH.	380 V	25	0642760000

Information

Type	Current [A]	Qty.	Order No.
Q 2 AKZ4	32	50	0336400000
Q 3 AKZ4	32	50	0336500000
Q 4 AKZ4	32	50	0336600000

Current [A]			
QB 2 WI RA6 IS	27	50	0482700000
QB 3 WI RA6 IS	27	50	0482800000
QB 4 WI RA6 IS	27	50	0482900000

Current [A]			
AP DK4		20	0359260000

Current [A]			
STB 8.5/D4/2.3/M2.5 AKZ		50	0215700000

Current [A]			
PS 2.3 RT		20	0180400000

Current [A]			
VH 10/4/2.8 AKZ4		50	0446600000

Current [A]			
VL 2 AKZ4/DK4		50	0446700000

Type	Current [A]	Qty.	Order No.
BFSC M2.5X14 SAKD2.5N		100	0266800000
TSCH 4 AKZ4		100	0363360000

Current [A]			
DEK 6			

Modular terminals with electronic components

DK 4 D/5

4 mm²

Diodes terminal for lamp-test-circuits

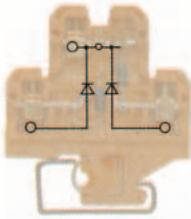

6 x 50 x 56.5
10 / 4
0.33 ... 4

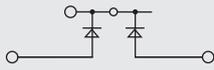

IEC	UL	CSA	EN 50019
380			
10			
4			



1000 / 1

/ 1000

Rated connection	Additional connection
0.5...4 / 0.5...4	
0.5...4 / 0.5...4	
0.5...0.8 (M3)	
9 / 3.5 x 0.6	

Type	Spannung	Qty.	Order No.
DK 4/32 2D CSA A2	380 V	25	0523760000

Type	Current [A]	Qty.	Order No.
Q 2 AKZ4	32	50	0336400000
Q 3 AKZ4	32	50	0336500000
Q 4 AKZ4	32	50	0336600000

	Current [A]	Qty.	Order No.
QB 2 WI RA6 IS	27	50	0482700000
QB 3 WI RA6 IS	27	50	0482800000
QB 4 WI RA6 IS	27	50	0482900000

AP DK4	20	0359260000
--------	----	------------

STB 8.5/D4/2.3/M2.5 AKZ	50	0215700000
-------------------------	----	------------

PS 2.3 RT	20	0180400000
-----------	----	------------

VH 10/4/2.8 AKZ4	50	0446600000
------------------	----	------------

VL 2 AKZ4/DK4	50	0446700000
---------------	----	------------

BFSC M2.5X14 SAKD2.5N	100	0266800000
-----------------------	-----	------------

TSCH 4 AKZ4	100	0363360000
-------------	-----	------------

DEK 6		
-------	--	--

DK 4 D/6

4 mm²

Diodes terminal for lamp-test-circuits

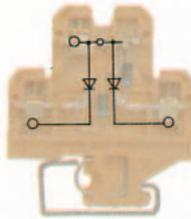

6 x 50 x 56.5
10 / 4
0.33 ... 4

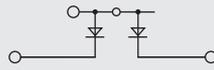

IEC	UL	CSA	EN 50019
380			
10			
4			



1000 / 1

/ 1000

Rated connection	Additional connection
0.5...4 / 0.5...4	
0.5...4 / 0.5...4	
0.5...0.8 (M3)	
9 / 3.5 x 0.6	

Type	Spannung	Qty.	Order No.
DK 4/32 2D A1	380 V	25	0663960000

Type	Current [A]	Qty.	Order No.
Q 2 AKZ4	32	50	0336400000
Q 3 AKZ4	32	50	0336500000
Q 4 AKZ4	32	50	0336600000

	Current [A]	Qty.	Order No.
QB 2 WI RA6 IS	27	50	0482700000
QB 3 WI RA6 IS	27	50	0482800000
QB 4 WI RA6 IS	27	50	0482900000

AP DK4	20	0359260000
--------	----	------------

STB 8.5/D4/2.3/M2.5 AKZ	50	0215700000
-------------------------	----	------------

PS 2.3 RT	20	0180400000
-----------	----	------------

VH 10/4/2.8 AKZ4	50	0446600000
------------------	----	------------

VL 2 AKZ4/DK4	50	0446700000
---------------	----	------------

BFSC M2.5X14 SAKD2.5N	100	0266800000
-----------------------	-----	------------

TSCH 4 AKZ4	100	0363360000
-------------	-----	------------

DEK 6		
-------	--	--

DK 4 D/7

4 mm²

Diodes terminal for lamp-test-circuits with multiplier

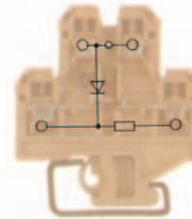

6 x 50 x 56.5
10 / 4
0.33 ... 4

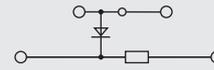

IEC	UL	CSA	EN 50019
24			
10			
4			



/ 1

/ 1000

Rated connection	Additional connection
0.5...4 / 0.5...4	
0.5...4 / 0.5...4	
0.5...0.8 (M3)	
9 / 3.5 x 0.6	

Type	Spannung	Qty.	Order No.
DK 4/32 1D 1K5	24 V	25	0685260000

Type	Current [A]	Qty.	Order No.
Q 2 AKZ4	32	50	0336400000
Q 3 AKZ4	32	50	0336500000
Q 4 AKZ4	32	50	0336600000

	Current [A]	Qty.	Order No.
QB 2 WI RA6 IS	27	50	0482700000
QB 3 WI RA6 IS	27	50	0482800000
QB 4 WI RA6 IS	27	50	0482900000

AP DK4	20	0359260000
--------	----	------------

STB 8.5/D4/2.3/M2.5 AKZ	50	0215700000
-------------------------	----	------------

PS 2.3 RT	20	0180400000
-----------	----	------------

VH 10/4/2.8 AKZ4	50	0446600000
------------------	----	------------

VL 2 AKZ4/DK4	50	0446700000
---------------	----	------------

BFSC M2.5X14 SAKD2.5N	100	0266800000
-----------------------	-----	------------

TSCH 4 AKZ4	100	0363360000
-------------	-----	------------

DEK 6		
-------	--	--

Modular terminals with electronic components

With electronic components TS 32 / PA

DK 4 D/8

4 mm²

Diodes terminal for lamp-test-circuits with multiplier

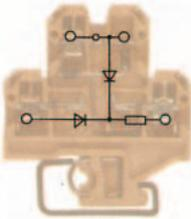

When using ATEX certified components in hazardous area applications the installation instructions and the rated data for accessories in the technical appendix must be considered.

Width/Length/Height with TS32	mm
Max. current / max. cond. cross-section	A/mm ²
Max. clamping range	mm ²

6 x 50 x 56.5	
10 / 4	
0.33 ... 4	

B

Technical data

Rated data	
Rated voltage	V
Rated current	A
Rated cross-section	mm ²
Rated impulse voltage / Pollution severity	kV/-
Plug gauge IEC 60-947-1 / flammability class acc. UL 94	
Approvals	
Electronic built-in components	
Diode current / diode voltage	V / A
voltage LED / current LED / polarity	V / mA / -
Resistance / Varistor	-/N
Clampable conductors (H05V/H07V)	
Solid / stranded	mm ²
Flexible / flexible w. wire end ferrule	mm ²
Tightening torque range (clamping screw)	Nm
Stripping length / blade size	mm / -
Information	

IEC	UL	CSA	EN 50019
24			
10			
4			
		/ 3	
		A3 / V2	
/ 1			
Rated connection		Additional connection	
0.5...4 / 0.5...4			
0.5...4 / 0.5...4			
0.5...0.8 (M3)			
9 / 3.5 x 0.6			
Information			

Order data

Version	
Terminal components	LED red
see circuit diagram above	LED green
	Neon lamp
	Neon lamp
Information	

Type	Spannung	Qty.	Order No.
DK 4/32 2D 1K5	24 V	25	0159160000
Information			

Accessories

Cross-connection, screwable	
(Q)	2-pole
	3-pole
	4-pole
	10-pole
External cross-connection	
	2-pole
	3-pole
	4-pole
End plate	
	beige
Socket	
Test plug	
Connecting sleeve	
Cross-connection saddle	
Fixing screw / Partition disc	
	Fixing screw
	Partition disc
Marking systems	
For detailed information on other accessories and applications see "Accessories"	

Type	Current [A]	Qty.	Order No.
Q 2 AKZ4	32	50	0336400000
Q 3 AKZ4	32	50	0336500000
Q 4 AKZ4	32	50	0336600000
Current [A]			
QB 2 WI RA6 IS	27	50	0482700000
QB 3 WI RA6 IS	27	50	0482800000
QB 4 WI RA6 IS	27	50	0482900000
AP DK4		20	0359260000
STB 8.5/D4/2.3/M2.5 AKZ		50	0215700000
PS 2.3 RT		20	0180400000
VH 10/4/2.8 AKZ4		50	0446600000
VL 2 AKZ4/DK4		50	0446700000
BFSC M2.5X14 SAKD2.5N		100	0266800000
TSCH 4 AKZ4		100	0363360000
Information			
DEK 6			
Information			

Modular terminals with electronic components

With electronic components TS 32 / PA

SAKT 1 GL

10 mm²

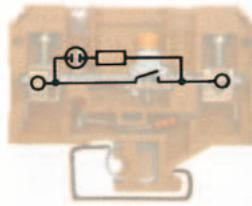

When using ATEX certified components in hazardous area applications the installation instructions and the rated data for accessories in the technical appendix must be considered.

Width/Length/Height with TS32	mm
Max. current / max. cond. cross-section	A/mm ²
Max. clamping range	mm ²

8 x 65 x 52.5
27 / 10
0.5 ... 10

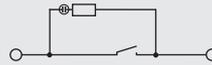

Technical data

Rated data	
Rated voltage	V
Rated current	A
Rated cross-section	mm ²
Rated impulse voltage / Pollution severity	kV/-
Plug gauge IEC 60-947-1 / flammability class acc. UL 94	
Approvals	

Electronic built-in components

Diode current / diode voltage	V / A
voltage LED / current LED / polarity	V / mA / -
Resistance / Varistor	-/N

Clampable conductors (H05V/H07V)

Solid / stranded	mm ²
Flexible / flexible w. wire end ferrule	mm ²
Tightening torque range (clamping screw)	Nm
Stripping length / blade size	mm / -

Information

IEC 60947-7-1

IEC	UL	CSA	EN 50019
230			
27			
10			
/ 5VA			



Rated connection	Additional connection
0.5...10	
0.5...6	
0.8...1.6 (M 3.5)	
12 / 4.0 x 0.8	

Tightening torque 1.6 Nm for 10 mm² stranded wire.

Order data

Version	
Terminal components	LED red
see circuit diagram above	LED green
	Neon lamp
	Neon lamp

Information

Type	Spannung	Qty.	Order No.
SAKT 1/32 GL 230VAC	230 VAC	25	0333620000

Accessories

Cross-connection, screwable	
	2-pole
	3-pole
	4-pole
(Q)	10-pole

External cross-connection	
	2-pole
	3-pole
	4-pole

End plate	
	beige

Socket

Test plug

Connecting sleeve

Cross-connection saddle

Fixing screw / Partition disc	
	Fixing screw
	Partition disc

Marking systems

For detailed information on other accessories and applications see "Accessories"

Type	Current [A]	Qty.	Order No.

Current [A]			
QB 2 SAKT1	50		0205700000
QB 3 SAKT1	50		0205800000
QB 4 SAKT1	50		0205900000

AP SAKB/C/T KRG	20	0146720000
-----------------	----	------------

STB 14/D6/4/M3 SAK10	50	0169900000
----------------------	----	------------

PS 2.3 RT	20	0180400000
-----------	----	------------

VH 12/4.9/3.3 SAK6N	100	0249000000
---------------------	-----	------------

TSCH 2	100	0353660000
--------	-----	------------

DEK 6		
-------	--	--

Modular terminals with electronic components

With electronic components TS 32 / PA

When using ATEX certified components in hazardous area applications the installation instructions and the rated data for accessories in the technical appendix must be considered.

Width/Length/Height with TS32	mm
Max. current / max. cond. cross-section	A/mm ²
Max. clamping range	mm ²

Technical data

Rated data	
Rated voltage	V
Rated current	A
Rated cross-section	mm ²
Rated impulse voltage / Pollution severity	kV/-
Plug gauge IEC 60-947-1 / flammability class acc. UL 94	
Approvals	

Electronic built-in components	
Diode current / diode voltage	V / A
voltage LED / current LED / polarity	V / mA / -
Resistance / Varistor	-/V

Clampable conductors (H05V/H07V)	
Solid / stranded	mm ²
Flexible / flexible w. wire end ferrule	mm ²
Tightening torque range (clamping screw)	Nm
Stripping length / blade size	mm / -

Information

Order data

Version	
Terminal components	LED red
see circuit diagram above	LED green
	Neon lamp
	Neon lamp

Information

Accessories

Cross-connection, screwable	
	2-pole
	3-pole
	4-pole
	10-pole

External cross-connection	
	2-pole
	3-pole
	4-pole

End plate	
	beige

Socket

Test plug

Connecting sleeve

Cross-connection saddle

Fixing screw / Partition disc	
	Fixing screw
	Partition disc

Marking systems

For detailed information on other accessories and applications see "Accessories"

DK 4 RC

4 mm²

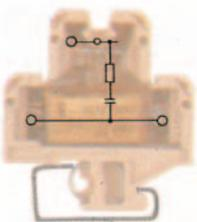

18 x 50 x 56.5
10 / 4
0.33 ... 4

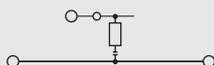

IEC	UL	CSA	EN 50019
230			
10			
4			
		/ 3	
		A3 / V2	

Rated connection	Additional connection
0.5...4 / 0.5...4	
0.5...4 / 0.5...4	
0.5...0.8 (M 3)	
9 / 3.5 x 0.6	

Type	Spannung	Qty.	Order No.
DK 4/32 RC 220R/220NF	230 V	5	0692160000

Type	Current [A]	Qty.	Order No.
Q 2 AKZ4	32	50	0336400000
Q 3 AKZ4	32	50	0336500000
Q 4 AKZ4	32	50	0336600000

	Current [A]		
QB 2 WI RA6 IS	27	50	0482700000
QB 3 WI RA6 IS	27	50	0482800000
QB 4 WI RA6 IS	27	50	0482900000

AP DK4		20	0359260000

STB 8.5/D4/2.3/M2.5 AKZ		50	0215700000

PS 2.3 RT		20	0180400000

TSCH 4 AKZ4		100	0363360000

DKT 4 PT 100

4 mm²

Diodes terminal for central control systems

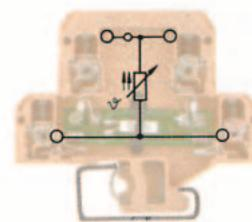

6 x 65 x 56.5
10 / 4
0.33 ... 4

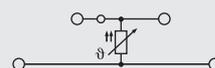

IEC	UL	CSA	EN 50019
10			
4			
		/ 3	
		A3 / V2	

Rated connection	Additional connection
0.5...4 / 0.5...4	
0.5...4 / 0.5...2.5	
0.4...0.7 (M 2.5)	
6 / 3.5 x 0.6	

Type	Spannung	Qty.	Order No.
DKT 4/32 PT100		10	8014730000

Type	Current [A]	Qty.	Order No.
Q 2 AKZ4	32	50	0336400000
Q 3 AKZ4	32	50	0336500000
Q 4 AKZ4	32	50	0336600000

	Current [A]		
QB 2 WI RA6 IS	27	50	0482700000
QB 3 WI RA6 IS	27	50	0482800000
QB 4 WI RA6 IS	27	50	0482900000

AP DKT4 PA		20	0687560000

STB 8.5/D4/2.3/M2.5 AKZ		50	0215700000

PS 2.3 RT		20	0180400000

TSCH 4 AKZ4		100	0363360000

DEK 6

Terminal Blocks



Modular feed-through terminals	
TS 35 + TS 32 / PA	C.2 - C.4
Fuse terminals	
TS 35 + TS 32 / PA	C.5

Modular feed-through terminals

TS 35 + TS 32 / PA

SAK 2.5/EN

2.5 mm²

SAK 4/EN

4 mm²

When using ATEX certified components in hazardous area applications the installation instructions and the rated data for accessories in the technical appendix must be considered.

width x length x height, min. height	mm
Max. current / max. cond. cross-section	A/mm ²
Max. clamping range	mm ²

6.1 x 41.5 x 42.5	
41 / 6	
0.13 ... 6	

6.5 x 42 x 47.5	
41 / 6	
0.13 ... 6	

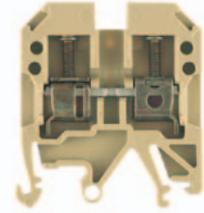
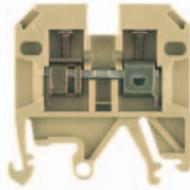

Technical data

Rated data	
Rated voltage	V
Rated current	A
Rated cross-section	mm ²
Rated impulse voltage / Pollution severity	kV/-
Plug gauge IEC 60-947-1 / flammability class acc. UL 94	
Approvals	

IEC 60947-7-1 EEx e II 2 G D

IEC	UL	CSA	EN 50019
800	600	600	550
24	25	25	21
2.5	AWG 22...12	AWG 26...10	2.5
8 / 3 / V2			

KEMA 97ATEX1798 U

IEC 60947-7-1 EEx e II 2 G D

IEC	UL	CSA	EN 50019
800	600	600	550
32	30	36	28
4	AWG 22...12	AWG 26...10	4
8 / 3 A4 / V2			

KEMA 97ATEX1798 U

Clampable conductors (H05V/H07V)	
Solid / stranded	mm ²
Flexible / flexible w. wire end ferrule	mm ²
Tightening torque range (clamping screw)	Nm
Stripping length / blade size	mm / -

Rated connection	Additional connection
0.5...6 / 0.5...4	
0.5...4 / 0.5...4	
0.4...0.6 (M 2.5)	
10 / 3.5 x 0.6	

Rated connection	Additional connection
0.5...6 / 0.5...4	
0.5...4 / 0.5...4	
0.5...1.0 (M 3)	
12 / 3.5 x 0.6	

2 clampable conductors of equal cross-section	
Solid / stranded	mm ²
Flexible / flexible w. wire end ferrule	mm ²

1,5 / 0.5...4

1.5...1.5
0.5...1.5

Information

To use twin ferrules is the rated voltage 690 V.

To use twin ferrules is the rated voltage 690 V.

Order data

Version	
	beige
	blue

Type	Qty.	Order No.
SAK 2.5/EN	100	0218660000
SAK 2.5/EN BL	100	0218680000

Type	Qty.	Order No.
SAK 4/EN	100	0467460000
SAK 4/EN BL	100	0467480000

Information

Accessories

Cross-connection, screwable	
	2-pole
	3-pole
	4-pole
	10-pole
	Connecting sleeve
	Fixing screw
	Fuse cartridges

Type	Current [A]	Qty.	Order No.
Q 2 SAK2.5	41	50	0337000000
Q 3 SAK2.5	41	50	0337100000
Q 4 SAK2.5	41	50	0337200000
Q 10 SAK2.5	41	20	0368700000

Type	Current [A]	Qty.	Order No.
Q 2 SAK4	41	50	0336700000
Q 3 SAK4	41	50	0336800000
Q 4 SAK4	41	50	0336900000
Q 10 SAK4	41	20	0368800000

Cross-connection saddle	
	Cross-connection saddle
	Connecting sleeve
	Fixing screw

VL 2 SAK4	50	0197000000
VH 19/5/3.5 SAK4-16	50	0285100000
BFSC M3X25	100	0292500000

Socket / Test plug	
	Socket
	Test plug

STB 8.5/5/2.3/M3 SAK2.5	50	0280600000
PS 2.3 RT	20	0180400000

STB 14/D5/2.3/M3 SAK2.5	50	0168600000
PS 2.3 RT	20	0180400000

End plate	
	beige
	blue

Width [mm]		
AP SAK2.5/35 + AST3+4	1.5 20	0460580000
AP SAK2.5/35 BL	1.5 20	0460580000

Width [mm]		
AP SAK4-10	1.5 20	0117960000
AP SAK4-10 BL	1.5 20	0117980000

Partition / Partition disc	
	beige
	blue
	Partition disc

Width [mm]		
TW SAK2.5	2.5 20	0302860000
TW SAK2.5 BL	1.5 20	0302880000
TSCH 1	2 100	0319160000

Width [mm]		
TW 4 SAK4-10	1.5 20	0130160000
TW 4 SAK4-10 BL	1.5 20	0130180000
TSCH 1	2 100	0319160000

Cover / fixing screw (plastic)	
	Cover
	Fixing screw (plastic)

AD 3 SAK2.5	50	0297900000
BFSC M3X22 PA/RT	100	0128900000

AD 4 SAK4	50	0285300000
BFSC M3X22 PA/RT	100	0128900000

Marking systems

DEK 6

DEK 6

Detailed information on all versions in chapter accessories.

Modular feed-through terminals

SAK 6/EN

6 mm²

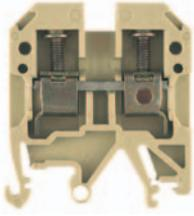

8 x 40 x 47.5
57 / 10
0.33 ... 10

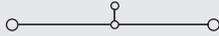

IEC 60947-7-1

EEx e II II 2 G D

IEC	UL	CSA	EN 50019
800	600	600	550
41	40	47	36
6	AWG 22...8	AWG 26...6	6
8 / 3			
A5 / V2			



KEMA 97ATEX1798 U

Rated connection	Additional connection
0.5...10 / 0.5...6	
0.5...10 / 0.5...6	
0.8...1.6 (M 3.5)	
12 / 4.0 x 0.8	

To use twin ferrules is the rated voltage 690 V.

SAK 10/EN

10 mm²

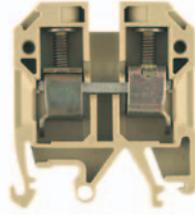

10 x 41.5 x 47.5
76 / 16
1.5 ... 16

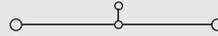

IEC 60947-7-1

EEx e II II 2 G D

IEC	UL	CSA	EN 50019
800	600	600	550
57	60	65	50
10	AWG 14...6	AWG 16...6	10
8 / 3			
B6 / V2			



KEMA 97ATEX1798 U

Rated connection	Additional connection
1.5...10 / 1.5...16	
1.5...16 / 1.5...10	
2.0...2.4 (M 4)	
12 / 5.5 x 1.0	

Tightening torque 2 Nm for 10 and 16 mm² stranded and AWG 6/7 wire.

SAK 16/EN

16 mm²

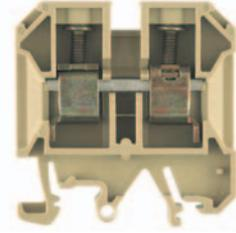

12 x 50 x 53.5
76 / 16
2.5 ... 16

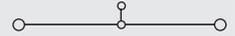

IEC 60947-7-1

EEx e II II 2 G D

IEC	UL	CSA	EN 50019
1000	600	600	750
76	80	87	66
16	AWG 12...6	AWG 16...6	16
8 / 3			
B6 / V2			



KEMA 97ATEX1798 U

Rated connection	Additional connection
2.5...16 / 4...16	
4...16 / 4...16	
2.0...2.4 (M 4)	
15 / 5.5 x 1.0	

Installation of the QL side by side use a TW/AP.

Type	Qty.	Order No.
SAK 6/EN	100	0212860000
SAK 6/EN BL	100	0212880000

Type	Qty.	Order No.
SAK 10/EN	100	0337660000
SAK 10/EN BL	100	1784410000

Type	Qty.	Order No.
SAK 16/EN	50	0339760000
SAK 16/EN BL	50	1784390000

Type	Current [A]	Qty.	Order No.
Q 2 SAK6N	57	50	0456700000
Q 3 SAK6N	57	50	0456800000
Q 4 SAK6N	57	50	0456900000
Q 10 SAK6N	57	20	0457000000

Type	Current [A]	Qty.	Order No.
Q 2 SAK10	57	50	0457100000
Q 3 SAK10	57	50	0457200000
Q 4 SAK10	57	50	0457300000
Q 10 SAK10	57	20	0457400000

Type	Current [A]	Qty.	Order No.
Q 2 SAK16	76	50	0457500000
Q 3 SAK16	76	50	0457600000
Q 4 SAK16	76	50	0457700000
Q 10 SAK16	76	20	0457800000

VL 2 SAK6N/SAKT	50	0194700000
VH 19/5/3.5 SAK4-16	50	0285100000
BFSC M3X25	100	0292500000

VL 2 SAK6N/SAKT	50	0194700000
VH 19/5/3.5 SAK4-16	50	0285100000
BFSC M3X25	100	0292500000

VL 2 SAK16/SAKA	50	0135800000
VH 19/5/3.5 SAK4-16	50	0285100000
BFSC M3X25	100	0292500000

STB 14/D6/4/M3 SAK10	50	0169900000
PS 4 F.STB 4	20	0299600000

STB 14/D6/4/M3 SAK10	50	0169900000
PS 4 F.STB 4	20	0299600000

STB 14/D6/4/M3 SAK10	50	0169900000
PS 4 F.STB 4	20	0299600000

Width [mm]			
AP SAK4-10	1.5	20	0117960000
AP SAK4-10 BL	1.5	20	0117980000

Width [mm]			
AP SAK4-10	1.5	20	0117960000
AP SAK4-10 BL	1.5	20	0117980000

Width [mm]			
AP SAK16	1.5	20	0271160000
AP SAK16 BL	1.5	20	0271180000

Width [mm]			
TW 4 SAK4-10	1.5	20	0130160000
TW 4 SAK4-10 BL	1.5	20	0130180000
TSCH 1	2	100	0319160000

Width [mm]			
TW 4 SAK4-10	1.5	20	0130160000
TW 4 SAK4-10 BL	1.5	20	0130180000
TSCH 1	2	100	0319160000

Width [mm]			
TSCH 1	2	100	0319160000

AD 4 SAK6N	50	0196600000
BFSC M3X22 PA/RT	100	0128900000

AD 4 SAK10	50	0178600000
BFSC M3X22 PA/RT	100	0128900000

AD 4 SAK16	50	0518200000
BFSC M3X22 PA/RT	100	0128900000

DEK 8

DEK 5

DEK 5

Modular feed-through terminals

TS 35 + TS 32 / PA

SAK 35/EN

35 mm²

TS 35 + TS 32 / PA

C

When using ATEX certified components in hazardous area applications the installation instructions and the rated data for accessories in the technical appendix must be considered.

width x length x height, min. height	mm
Max. current / max. cond. cross-section	A/mm ²
Max. clamping range	mm ²

18 x 58 x 63.5

150 / 50

2.5 ... 50

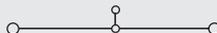

Technical data

Rated data

Rated voltage	V
Rated current	A
Rated cross-section	mm ²
Rated impulse voltage / Pollution severity	kV/-
Plug gauge IEC 60-947-1 / flammability class acc. UL 94	
Approvals	

IEC 60947-7-1

EEx e II II 2 G D

IEC	UL	CSA	EN 50019
800	600	600	550
125	105	145	109
35	AWG 12...2	AWG 12...2	35
8 / 3			
B8 / V2			



KEMA 97ATEX1798 U

Clampable conductors (H05V/H07V)

Solid / stranded	mm ²
Flexible / flexible w. wire end ferrule	mm ²
Tightening torque range (clamping screw)	Nm
Stripping length / blade size	mm / -

Rated connection

2.5...16 / 4...50
2.5...35 / 2.5...35
4.0...5.0 (M 6)
18 / 6.5 x 1.2

Additional connection

2 clampable conductors of equal cross-section

Solid / stranded	mm ²
Flexible / flexible w. wire end ferrule	mm ²

2.5...16...16
2.5...16 / 2.5...16

Information

Installation of the QL side by side use a TW/AP.

Order data

Version

beige
blue

Information

Type	Qty.	Order No.
SAK 35/EN	20	0339860000
SAK 35/EN BL	20	1784400000

Accessories

Cross-connection, screwable

	2-pole
	3-pole
	4-pole
	10-pole
	Connecting sleeve
	Fixing screw
	Fuse cartridges

(Q)

Type	Current [A]	Qty.	Order No.
QL 2 SAK35	99	20	0123600000
QL 3 SAK35	99	20	0123700000
QL 4 SAK35	99	20	0123800000
QL 10 SAK35	99	20	0338600000
VH 17/8/5 SAK35		50	0267000000
BFSC M4X30		50	0267100000
SS M4 D 128-A 4		100	0136400000

Cross-connection saddle

Cross-connection saddle
Connecting sleeve
Fixing screw

Socket / Test plug

Socket
Test plug

STB 16/D7/4/M4 SAK35	50	0140200000
PS 4 F.STB 4	20	0299600000

End plate

beige
blue

Width [mm]			
AP SAK35/TW SAK16	1.5	10	0303660000
AP SAK35/TW SAK16 BL	1.5	10	0303680000

Partition / Partition disc

beige
blue
Partition disc

Width [mm]			
TW SAK35	1.5	20	0304360000

Cover / fixing screw (plastic)

Cover
Fixing screw (plastic)

AD 4 SAK35	50	0178700000
BFSC M4X32 PA/RT	100	0129100000

Marking systems

DEK 5

Detailed information on all versions in chapter accessories.

Fuse terminals

TS 35 + TS 32 / PA

When using ATEX certified components in hazardous area applications the installation instructions and the rated data for accessories in the technical appendix must be considered.

Width/Length/Height with TS35x7.5	mm
Max. current / max. cond. cross-section	A/mm ²
Max. clamping range	mm ²

Technical data

Rated data	
Rated voltage for adjacent terminal	V
Rated current	A
Rated cross-section	mm ²
Rated impulse voltage / Pollution severity	kV/-
Plug gauge IEC 60-947-1 / flammability class acc. UL 94	
Approvals	

Clampable conductors (H05V/H07V)	
Solid / stranded	mm ²
Flexible / flexible w. wire end ferrule	mm ²
Tightening torque range (clamping screw)	Nm
Stripping length / blade size	mm / -

2 clampable conductors of equal cross-section	
Solid / stranded	mm ²
Flexible / flexible w. wire end ferrule	mm ²

Information

Order data

Version	
	500V ac/dc
	400V ac/dc
	250V ac/dc
with neon lamp	230V ac/dc
with LED	230V ac
with LED	230V dc
with neon lamp	115V ac/dc
with LED	115V ac
with LED	115V dc
with LED	60V ac
with LED	60V dc
mit lamp	48V ac/dc
with LED	48V ac
with LED	48V dc
with LED	24V ac
with LED	+ - 24V dc
mit lamp	24V ac/dc
	500V ac/dc

Information

Accessories

Cross-connection	
	2-pole
	3-pole
	4-pole
	10-pole

End plate / partition	(behind last terminal)
------------------------------	------------------------

Marking systems

For detailed information on other accessories and applications see "Accessories"

ASK 1

4 mm²

With or without LED

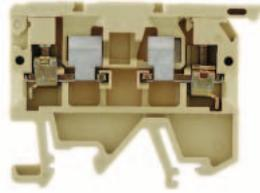

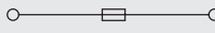
x 58 x 34	
6.3 / 4	
0.13 ... 4	

IEC	UL	CSA	EN 50019
500			
6.3	10	6.3	
4	AWG 22... 12	AWG 26... 12	
		6 / 3	
		A3 / V2	



Rated connection		Additional connection	
	0.5...4		
	0.5...4 / 0.5...4		
	0.5...1.0 (M 3)		
	9 / 3.5 x 0.6		

The rated cross-section is reduced to max. 2.5 mm² when using cross-connection bridges.

Type	Qty.	Order No.
ASK 1/EN	100	0474560000
ASK 1/EN LD 1D 230VAC	25	0225760000
ASK 1/EN LD 120K 230VDC	25	0225660000
ASK 1/EN LD 1D 115VAC	25	0225560000
ASK 1/EN LD 56K 115VDC	25	0225460000
ASK 1/EN LD 33K 60VDC	25	0226460000
ASK 1/EN LD 1D 48VAC	25	0225360000
ASK 1/EN LD 27K 48VDC	25	0225260000
ASK 1/EN LD 1D 24VAC	25	0222860000
ASK 1/EN LD 15K 24VDC	25	0222760000

Type	Current [A]	Qty.	Order No.
QB 2 WI RA8 IS		50	0461100000
QB 3 WI RA8 IS		50	0461200000
QB 4 WI RA8 IS		50	0461300000

Width [mm]	
AP ASK1	20

DEK 8

KDKS 1 LED

4 mm²

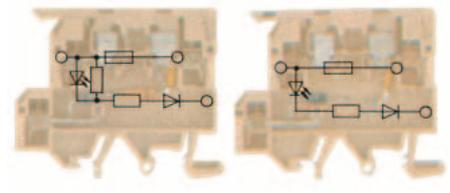

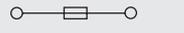
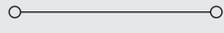
8 x 62.75 x 55.5	
6.3 / 4	
0.5 ... 4	

IEC	UL	CSA	EN 50019
6.3			
4			
		/ 3	
		A3 / V2	

Rated connection	
	0.5...4
	0.5...4 / 0.5...4
	0.6...0.8 (M 3)
	9 / 3.5 x 0.6

Type	Qty.	Order No.
KDKS1/EN LD 230VAC	25	8148910000
KDKS1/EN LD 115VAC	25	8142840000
KDKS1/EN LD 48 VAC	25	8148920000
KDKS1/EN LD 24 VAC	25	8148930000
KDKS1/EN LD 24VDC	25	8146450000

Type	Current [A]	Qty.	Order No.
QB 2 WI RA8 IS		50	0461100000
QB 3 WI RA8 IS		50	0461200000
QB 4 WI RA8 IS		50	0461300000

Width [mm]	
AP KDKS1 EN	20

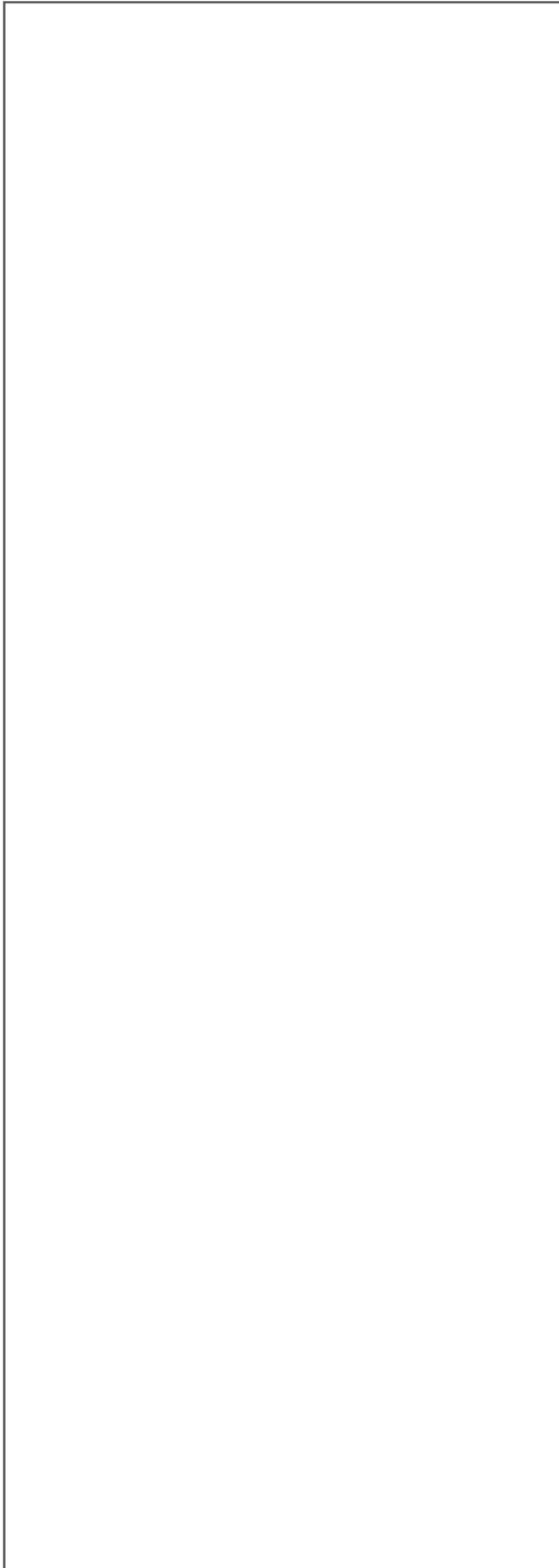

Modular terminals for high-temperature applications		
TS 32 / Ceramic	D.2	- D.3
Nuclear power terminal blocks		
Overview	D.4	- D.5
TS 32 / EP	D.6	- D.10

Modular terminals for high-temperature applications

TS 32 / Ceramic

When using ATEX certified components in hazardous area applications the installation instructions and the rated data for accessories in the technical appendix must be considered.

Width/Length/Height with TS32	mm
Max. current / max. cond. cross-section	A/mm ²
Max. clamping range	mm ²

Technical data

Rated data	
Rated voltage	V
Rated current	A
Rated cross-section	mm ²
Rated impulse voltage / Pollution severity	kV/-
Plug gauge IEC 60-947-1 / flammability class acc. UL 94	
Approvals	

Clampable conductors (H05V/H07V)	
Solid / stranded	mm ²
Flexible / flexible w. wire end ferrule	mm ²
Tightening torque range (clamping screw)	Nm
Stripping length / blade size	mm / -

2 clampable conductors of equal cross-section	
Solid / stranded	mm ²
Flexible / flexible w. wire end ferrule	mm ²

Information
Don't use a mechanic or automatic screw driver to fix the wire.

Order data

Version	white
Information	

Accessories

Cross-connection, screwable	
	
2-pole	
3-pole	
4-pole	
10-pole	
Connecting sleeve	
Fixing screw	
Fuse cartridges	

Cross-connection saddle	
Cross-connection saddle	
Connecting sleeve	
Fixing screw	

Socket / Test plug	
Socket	
Test plug	

End plate	
white	
blue	

Partition / Partition disc	
white	
blue	
Partition disc	

Cover / fixing screw (plastic)	
Cover	
Fixing screw (plastic)	

Marking systems	
DEK 6,5	

Detailed information on all versions in chapter accessories.

SAKK 4 Sn

4 mm²

Tin Plated for high continuous temperatures - max. 250 °C

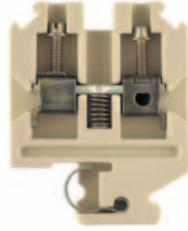

8 x 40 x 53	
41 / 6	
0.33 ... 6	

IEC 60947-7-1 EEx e II  II 2 G D

IEC	UL	CSA	EN 50019
800			275
32			28
4			4
		8 / 3	
		A4 / 5VB	

Rated connection		Additional connection	
0.5...6			
0.5...4 / 0.5...4			
0.5...1.0 (M3)			
10 / 3.5 x 0.6			

2 clampable conductors of equal cross-section	
Solid / stranded	mm ²
Flexible / flexible w. wire end ferrule	mm ²

Information
Don't use a mechanic or automatic screw driver to fix the wire.

Type	Qty.	Order No.
SAKK 4 KER/WS	50	1598080000
Information		

Type	Current [A]	Qty.	Order No.
QL 2 SAKK 4 TIN		100	9509420000
QL 3 SAKK 4 TIN		100	9509430000
QL 4 SAKK 4 TIN		50	9509440000
QL 10 SAKK 4 TIN		20	9509450000
VH 13.5 SAKK4		100	9509460000
BS(M3X20) SAKK 4&10		100	9503280000

Type	Current [A]	Qty.	Order No.
VH 13.5 SAKK4		100	9509460000
BS(M3X20) SAKK 4&10		100	9503280000

Width [mm]		Qty.	Order No.
AP SAKK4/10 KER/WS		10	9502630000

Width [mm]		Qty.	Order No.

DEK 6,5

Twin ferrule ZH 0.5 ... ZH 2.5 usable. End barrier MEW 1/32 order no. 0445600000; Locking pin SST3 order no. 0152700000

SAKK 4 Ni

4 mm²

Nickel Plated for fire rated application - max. 750°C for 3 hours

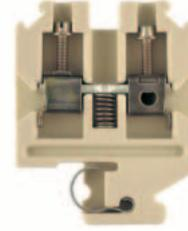

8 x 40 x 53	
41 / 6	
0.33 ... 6	

IEC 60947-7-1 EEx e II  II 2 G D

IEC	UL	CSA	EN 50019
800			275
32			28
4			4
		8 / 3	
		A4	

Rated connection		Additional connection	
0.5...6			
0.5...4 / 0.5...4			
0.5...1.0 (M3)			
10 / 3.5 x 0.6			

2 clampable conductors of equal cross-section	
Solid / stranded	mm ²
Flexible / flexible w. wire end ferrule	mm ²

Information
Don't use a mechanic or automatic screw driver to fix the wire.

Type	Qty.	Order No.
SAKK 4	50	9502600000
Information		

Type	Current [A]	Qty.	Order No.
QL 2 SAKK 4		n.a.	9502540000
QL 3 SAKK 4		n.a.	9502550000
QL 4 SAKK 4		n.a.	9502560000
QL 10 SAKK 4		n.a.	9502570000
VH 13.5 SAKK 4		100	9502580000
BS(M3X20) SAKK 4&10		100	9503280000

Type	Current [A]	Qty.	Order No.
VH 13.5 SAKK 4		100	9502580000
BS(M3X20) SAKK 4&10		100	9503280000

Width [mm]		Qty.	Order No.
AP SAKK4/10 KER/WS		10	9502630000

Width [mm]		Qty.	Order No.

DEK 6,5

End Barrier MEW 1/32 order no. 0445600000; Locking pin SST3 order no. 0152700000

Modular terminals for high-temperature applications

SAKK 10 Sn

10 mm²

Tin Plated for high continuous temperatures - max. 250 °C

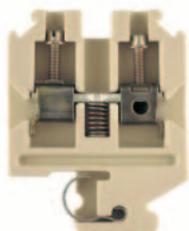

11.5 x 40 x 53
76 / 16
1.5 ... 16

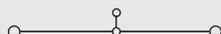

IEC 60947-7-1 EEx e II  II 2 G D

IEC	UL	CSA	EN 50019
800			275
57			50
10			10
8 / 3			
B6 / 5VB			

SIRA 03ATEX3425 U

Rated connection	Additional connection
1.5...16 / 1.5...16	
1.5...16 / 1.5...10	
2.0...2.4 (M 4)	
12 / 5.5 x 1.0	

Don't use a mechanic or automatic screw driver to fix the wire.

Type	Qty.	Order No.
SAKK 10 KER/WS	50	1598090000

SAKK 10 Ni

10 mm²

Nickel Plated for fire rated application - max. 750°C for 3 hours

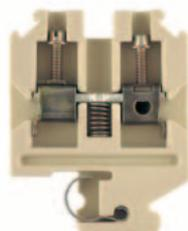

11.5 x 40 x 53
76 / 16
1.5 ... 16

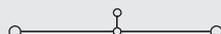

IEC 60947-7-1 EEx e II  II 2 G D

IEC	UL	CSA	EN 50019
800			275
57			50
10			10
8 / 3			
B6			

SIRA 03ATEX3425 U

Rated connection	Additional connection
1.5...16 / 1.5...16	
1.5...16 / 1.5...10	
2.0...2.4 (M 4)	
12 / 5.5 x 1.0	

Don't use a mechanic or automatic screw driver to fix the wire.

Type	Qty.	Order No.
SAKK 10	50	9502610000

Type	Current [A]	Qty.	Order No.
QL 2 SAKK 10 TIN	100	100	9509470000
QL 3 SAKK 10 TIN	50	50	9509480000
QL 4 SAKK 10 TIN	50	50	9509490000
QL 10 SAKK 10 TIN	20	20	9509500000
VH 12.5 SAKK10	50	50	9509510000
BS(M3X20) SAKK 4&10	100	100	9503280000

VH 12.5 SAKK10	50	50	9509510000
BS(M3X20) SAKK 4&10	100	100	9503280000

Width [mm]	Qty.	Order No.
AP SAKK4/10 KER/WS	10	9502630000

Width [mm]	Qty.	Order No.

DEK 5

End barrier MEW 1/32 order no. 0445600000; Locking pin SST3 order no. 0152700000

Type	Current [A]	Qty.	Order No.
QL 2 SAKK 10	100	100	9502650000
QL 3 SAKK 10	50	50	9502660000
QL 4 SAKK 10	50	50	9502670000
QL 10 SAKK 10	20	20	9502680000
VH 12.5 SAKK 10	50	50	9502690000
BS(M3X20) SAKK 4&10	100	100	9503280000

VH 12.5 SAKK 10	50	50	9502690000
BS(M3X20) SAKK 4&10	100	100	9503280000

Width [mm]	Qty.	Order No.
AP SAKK4/10 KER/WS	10	9502630000

Width [mm]	Qty.	Order No.

DEK 5

End barrier MEW 1/32 order no. 0445600000; Locking pin SST3 order no. 0152700000

Nuclear power terminal blocks

Terminal Blocks for the Containment Areas of Nuclear Power Generating Stations

NEQ
Nuclear Environmental Qualification
Test Report

REPORT NO. 42542-1 REVISION R
WYLE JOB NO. 42542
CUSTOMER 92.8048/999/QW
P. O. NO. _____
PAGE 1 OF 1317 PAGE REPORT A
DATE August 26, 1993
SPECIFICATION(S) See references
in Paragraph 5.0

1.0 CUSTOMER Weidmüller
ADDRESS Kilgenbergstraße 16, Postfach 2030, 5940 Detmold, Germany

2.0 TEST SPECIMEN Terminal Blocks

3.0 MANUFACTURER Weidmüller

4.0 SUMMARY

A Nuclear Environmental Qualification Test Program was performed on 67 test groups of various Weidmüller terminal blocks in accordance with Wyle Laboratories Nuclear Environmental Qualification Plan, 42541-00, Revision A. The test program was performed October 2, 1992 through June 25, 1993.

(1ka)

<p>STATE OF ALABAMA COUNTY OF MADISON</p> <p>Joseph T. Hazelton, P.E. Alabama Professional Engineer Reg. No. 16511</p> <p>Subscribed and sworn to before me this 7th day of August, 1993.</p> <p>Notary Public in and for the State of Alabama at large. My Commission expires <u>September 7, 1993</u></p>	<p>I hereby declare to submit for my signature of any kind in person or by proxy, independent of commercial design, manufacturing, or service covered by this report.</p> <p>PREPARED BY <u>D. E. Smith 8/25/93</u> <u>D. E. Smith</u> Project Engineer</p> <p>APPROVED BY <u>D. E. Smith 8/25/93</u> <u>D. E. Smith</u> Dept. Manager</p> <p>WYLE Q. A. <u>D. E. Smith 8/27/93</u> <u>D. E. Smith</u> P.O. Box 10000, Huntsville, AL 35894</p> <p>WYLE LABORATORIES SCIENTIFIC SERVICES & SYSTEMS GROUP HUNTSVILLE, ALABAMA</p>
---	---

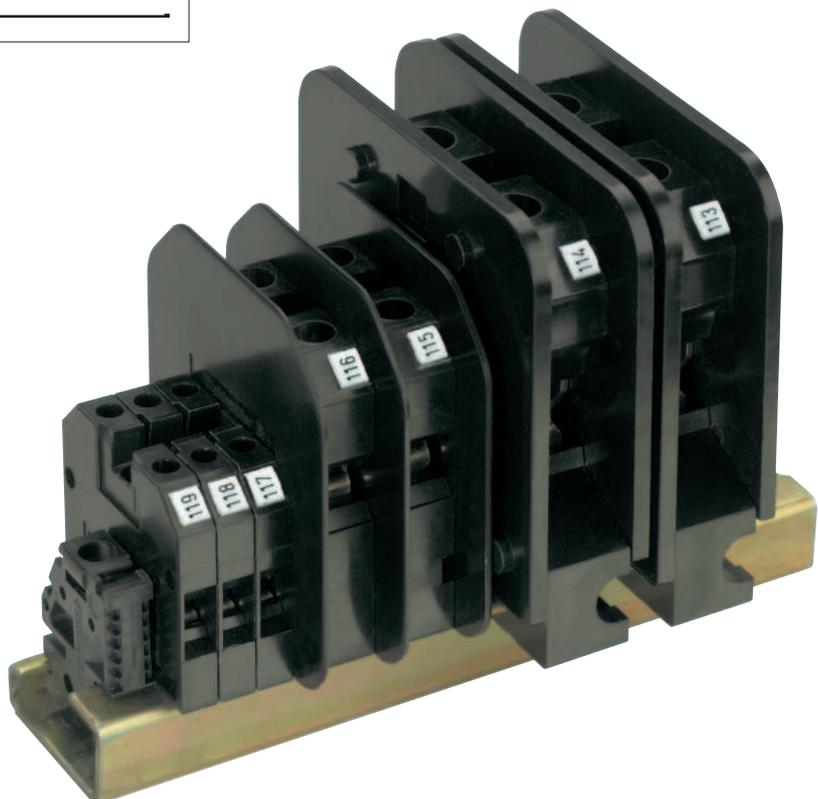
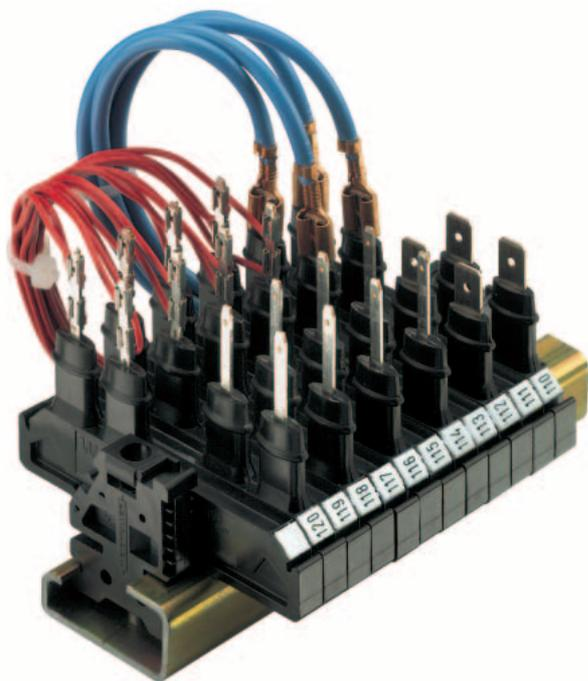

Nuclear power terminal blocks

High standards are set for products used in containment areas of nuclear power generating stations. Years of radioactive radiation must not lead to failure. Signals must be transmitted faultlessly in the case of accidents, for example, steam escaping after a coolant pipe burst.

In particular, steam enveloping the terminal blocks could lead to problems. Unsuitable terminal blocks cause leakage currents, which lead to signal distortions. That is why only products which have been approved in accordance with IEEE Class 1 E are allowed to be installed in containment areas.

The special feature of the tests carried out using Weidmüller's terminal blocks is that not only was the insulation resistance measured following an accident simulation, but that the leakage current was recorded during the LOCA test (Loss of Coolant Accident).

Weidmüller also offers for these applications a choice of products made from the special epoxy resin material EP with inorganic filler, which meets the demands for high standards.

The comprehensive test results produced by the Wyle Laboratories enable the regulatory body to judge Weidmüller's products for containment areas Class 1 E (accident simulation test profile 4) and for general use (accident simulation test profile 1) in nuclear generating stations.

- Basis:** **IEEE 323 – 1983**
 "Qualifying class 1 E Equipment for Nuclear Power Generating Stations"
IEE 344 – 1987
 "Recommended Practices for Seismic Qualification of Class 1 E Equipment for Nuclear Power Generating Stations"

Agency: Wyle Laboratories, Huntsville, Alabama, USA

Period: 1992 – 1993

The basis for the qualification statement are the standards laid down in the IEEE that comprise the following product cycles:

- 1. Functional Test/Initial Values**
 - Insulation resistance
 - Volume resistances
- 2. Radioactive Aging**
 - Total dose: 220 Mrad
 - Dose rate: 1 Mrad/h
 - Volume resistance after contamination
- 3. Thermal aging equivalent to 40 years of operation at ambient temperature**
 - 32 °C = 90 °F outside of containment area
 - 65 °C = 150 °F within the containment area
 - Accelerated aging
 - Insulation resistance after contamination
- 4. Earthquake Simulation**
 - 5 OBE, 1 SSE test in 3 axes
 - Monitoring of the electrical functions
- 5. Accident Simulation**
 - Inside and outside of the containment area
 - Monitoring of leakage currents for different applications during the accident simulation
 - Insulation resistance after contamination

6. Functional Test/Final Values

- Volume resistance
- Optical inspection

As well as the special terminal blocks for the containment areas, which correspond to the standards according to Class 1 E, Weidmüller has subjected a range of standard terminal blocks to intensive tests in accordance with test profile 1. They all fully meet the demands set for terminal blocks for outside of restricted areas.

Accident Simulation Test Profile 1 Typical PWR Outside Containment Simulation

During the 4-hour test, saturated steam is fed to the temperature control. This simulation is carried out at atmospheric pressure.

Accident Simulation Test Profile 4 Typical PWR Inside Containment Simulation

During the 29-hour test, saturated steam is fed to the temperature control. In the period from the 3rd to 24th hour, the test circuit that is coated with a chemical spray is alternatively coated with a demineralizing spray. This simulation is carried out at an increased pressure of a maximum of 4500 hPa (4.5 bar).

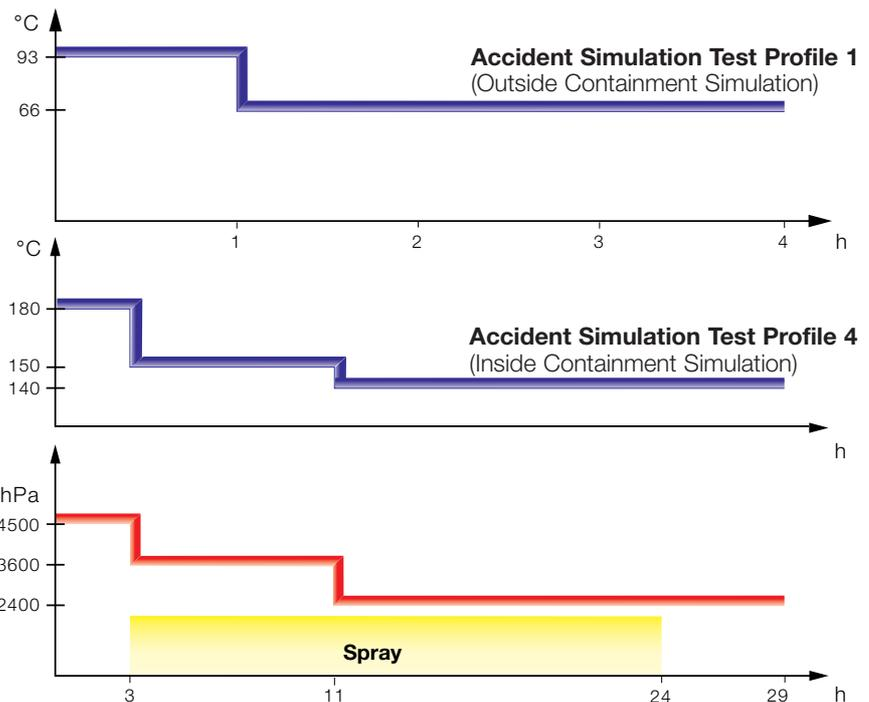

D

Modular terminals for nuclear power stations

TS 32 / EP

SAKH 4

4 mm²

SAKH 6

10 mm²

TS 32 / EP

When using ATEX certified components in hazardous area applications the installation instructions and the rated data for accessories in the technical appendix must be considered.

Width/Length/Height with TS32	mm
Max. current / max. cond. cross-section	A/mm ²
Max. clamping range	mm ²

6.5 x 40 x 51.5	
41 / 6	
0.13 ... 6	

14 x 57 x 76.5	
76 / 16	
0.5 ... 16	

Technical data

Rated data	
Rated voltage	V
Rated current	A
Rated cross-section	mm ²
Rated impulse voltage / Pollution severity	kV/-
Plug gauge IEC 60-947-1 / flammability class acc. UL 94	
Approvals	

IEC 60947-7-1				EEx e II II 2 G D	
IEC	UL	CSA	EN 50019		
800	600	600	550		
32	20	36	28		
4	AWG 22...12	AWG 26...10	4		
			8 / 3		
			A4 / V-0		

IEC 60947-7-1			
IEC	UL	CSA	EN 50019
1000			
57			
10			
		8 / 3	
		B6 / V-0	

Clampable conductors (H05V/H07V)	
Solid / stranded	mm ²
Flexible / flexible w. wire end ferrule	mm ²
Tightening torque range (clamping screw)	Nm
Stripping length / blade size	mm / -

Rated connection	Additional connection
0.5...6 / 0.5...4	
0.5...4 / 0.5...4	
0.5...1.0 (M3)	
12 / 3.5 x 0.6	

Rated connection	Additional connection
0.5...16 / 10...16	
0.5...10 / 0.5...10	
1.2...2.4 (M4)	
12 / 1.0 x 5.5	

2 clampable conductors of equal cross-section	
Solid / stranded	mm ²
Flexible / flexible w. wire end ferrule	mm ²

0.5...4	
0.5...4 / 0.5...4	

Information
The rated voltage is 630/690 V when using wire end ferrules without end cover or partition plates.

Order data

Version	
black	

Type	Qty.	Order No.
SAK 4 EP/SW	100	0128300000
SAK 4 CUN/EP/SW	100	0168800000

Type	Qty.	Order No.
SAKH 6 EP/SW	50	0126600000

Information

Accessories

Cross-connection, screwable	
	2-pole
	3-pole
	4-pole
	10-pole
Connecting sleeve	
Fixing screw	
Fuse cartridges	

Type	Current [A]	Qty.	Order No.
Q 2 SAK4	41	50	0336700000
Q 3 SAK4	41	50	0336800000
Q 4 SAK4	41	50	0336900000
Q 10 SAK4	41	20	0368800000

Type	Current [A]	Qty.	Order No.

Cross-connection saddle	
Cross-connection saddle	
Connecting sleeve	
Fixing screw	

Socket / Test plug	
Socket	STB 14/D5/2.3/M3 SAK2.5
Test plug	PS 4 F.STB 4

Width [mm]	

Width [mm]	
AP SAKH6-10 EP/SW	4 20 0131700000

Partition / Partition disc	
black	TW SAK4-10 EP/SW
blue	
Partition disc	

Width [mm]	
TW SAK4-10 EP/SW	2,5 20 0130100000

Width [mm]	
TW SAK4-10 EP/SW	2,5 20 0130100000

Cover / fixing screw (plastic)	
Cover	
Fixing screw (plastic)	

Marking systems	
DEK 5	

Marking systems	
DEK 5	

Detailed information on all versions in chapter accessories.

Modular terminals for nuclear power stations

SAKH 10

10 mm²

SAKH 35

35 mm²



14 x 57 x 76.5
57 / 16
1.5 ... 16



18 x 125 x 90
150 / 50
4 ... 50



IEC 60947-7-1

IEC	UL	CSA	EN 50019
1000			
57			
10			
	8 / 3		
	B6 / V-0		

IEC 60947-7-1

IEC	UL	CSA	EN 50019
1000			
125			
35			
	8 / 3		
	B8 / V-0		

Rated connection	Additional connection
1.5...16...16	
2.5...10 / 1...10	
1.2...2.4 (M 4)	
12 / 5.5 x 1.0	

Rated connection	Additional connection
4...16 / 16...50	
4...50 / 4...35	
4.0...5.0 (M 6)	
/ 6.5 x 1.2	

Type	Qty.	Order No.
SAKH 10 EP/SW	50	0126700000
SAKH 10 CUN/EP/SW	50	1104700000

Type	Qty.	Order No.
SAKH 35 EP/SW	20	1596240000
SAKH 35/M.AP CUN/EP/SW	20	1593540000

Type	Current [A]	Qty.	Order No.
Width [mm]			
AP SAKH6-10 EP/SW	4	20	0131700000
Width [mm]			
TW SAK4-10 EP/SW	2,5	20	0130100000

Type	Current [A]	Qty.	Order No.
Width [mm]			
Width [mm]			

DEK 5

DEK 6,5

Modular terminals for nuclear power stations

TS 32 / EP

KMVF LI 6.3 EP/SW

2.5 mm²

KMVF RE 6.3 EP/SW

2.5 mm²



When using ATEX certified components in hazardous area applications the installation instructions and the rated data for accessories in the technical appendix must be considered.

Width/Length/Height with TS32	mm
Max. current / max. cond. cross-section	A/mm ²
Max. clamping range	mm ²

6 x 70 x 54	6.3	6.3
20		

6 x 70 x 54	6.3	6.3
20		

Technical data

Rated data	
Rated voltage	V
Rated current	A
Rated cross-section	mm ²
Rated impulse voltage / Pollution severity	kV/-
Plug gauge IEC 60-947-1 / flammability class acc. UL 94	
Approvals	

IEC	UL	CSA	EN 50019
800			
16			
2.5			
	8 / 3		
	/ V-0		

IEC	UL	CSA	EN 50019
800			
16			
2.5			
	8 / 3		
	/ V-0		

Clampable conductors (H05V/H07V)	
Solid / stranded	mm ²
Flexible / flexible w. wire end ferrule	mm ²
Tightening torque range (clamping screw)	Nm
Stripping length / blade size	mm / -

Rated connection	Additional connection
0.5...2.5	

Rated connection	Additional connection
0.5...2.5	

2 clampable conductors of equal cross-section	
Solid / stranded	mm ²
Flexible / flexible w. wire end ferrule	mm ²

--	--

--	--

Information

250 V rated voltage with same-direction arrangement and 800 V with staggered arrangement of KMVF LI und KMVF RE alternating.
--

250 V rated voltage with same-direction arrangement and 800 V with staggered arrangement of KMVF LI und KMVF RE alternating.
--

Order data

Version
black

Type	Qty.	Order No.
KMVF LI 6.3 EP/SW	50	0249100000

Type	Qty.	Order No.
KMVF RE 6.3 EP/SW	50	0249200000

Information

--

--

Accessories

Cross-connection, screwable	
	2-pole
	3-pole
	4-pole
	10-pole
	Connecting sleeve
	Fixing screw
	Fuse cartridges

Type	Current [A]	Qty.	Order No.

Type	Current [A]	Qty.	Order No.

Cross-connection saddle	
	Cross-connection saddle
	Connecting sleeve
	Fixing screw

Socket / Test plug	
	Socket
	Test plug

End plate	
	black
	blue

Width [mm]	

Width [mm]	

Partition / Partition disc	
	black
	blue
	Partition disc

Width [mm]	

Width [mm]	

Cover / fixing screw (plastic)	
	Cover
	Fixing screw (plastic)

Marking systems	
	DEK 5

--	--	--	--

--	--	--	--

Detailed information on all versions in chapter accessories.

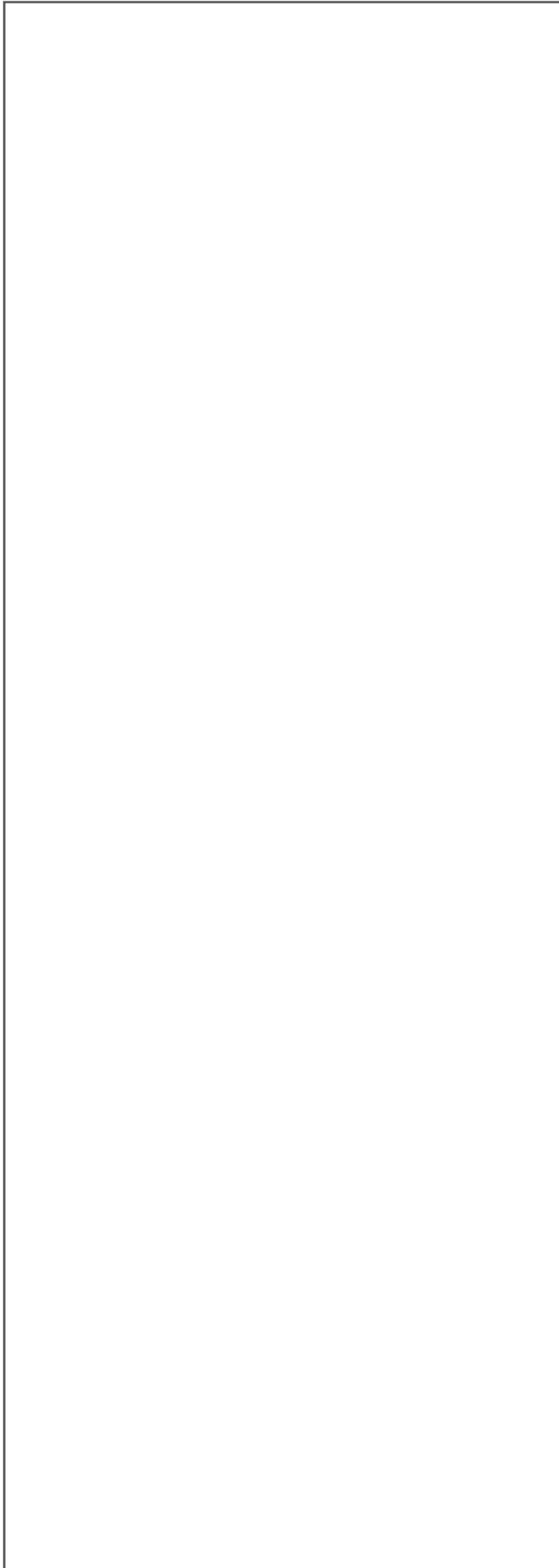

Mini Modular Terminals		
Mini Modular Terminals		
TS 15 / PA	E.2	- E.3
Modular PE terminals		
TS 15 / PA	E.4	- E.6
Fuse terminals		
TS 15 / PA	E.7	
With push-on connection		
TS 15 / PA	E.8	- E.9
With solder connection		
TS 15 / PA	E.10	- E.13
With Termi-Point / Wire-Wrap connection		
TS 15 / PA	E.14	- E.15

Mini Modular Terminals

Modular feed-through terminal Modular disconnect test terminal

TS 15/PA

Please observe the installation instructions and the rated data for accessories in the "Technical appendix" section when using these terminals in EEx e applications.

width x length x height on TS15x5.5	mm
max. current / max. conductor	A/mm ²
max. clamping range	mm ²

Technical specification

Rated data	
Rated voltage (to adjacent terminal for PE)	V
Rated current	A
Rated cross-section	mm ²
Rated surge voltage / Pollution severity	kV/-
IEC 60-947-1 gauge / UL 94 combustibility class	
Approvals	

Clamped conductors (H05V/H07V)

solid / multistrand	mm ²
fine strand / fine strand w. wire end ferrule	mm ²
Tightening torque, clamping screw	Nm
Stripping length / Blade size	mm / -

2 clamped conductors, equal cross-section H05V/H07V

solid / multistrand	mm ²
fine strand / fine strand w. wire end ferrule	mm ²

Note

Ordering data

Model	
	dark beige, Wemid (PA)
	blue, Wemid (PA)
	green/yellow, Wemid (PA)

Note

Accessories

Screwed cross-connection

	Q3	2-pole	24	50	0368200000
		3-pole	24	50	0368300000
		4-pole	24	50	0368400000
		10-pole	24	50	0368500000

End cover plate/Partition plate

End cover plate	
End cover plate	dark beige, Wemid
	blue, Wemid
Partition plate	
Partition plate	dark beige, Wemid
	blue, Wemid

End bracket

End bracket	dark beige
-------------	------------

Testing / Checking

Socket	STB 8.5/D4/2.3/M2.5 AKZ	50	0215700000
Test plug	PS 2.3 RT	20	0180400000

Labelling systems (see selection in chapter M)

Labelling tags	DEK 5
----------------	-------

Detailed information on other accessories and their use can be found in the "Accessories" section.

AKZ 1.5

1.5 mm²

Modular feed-through terminal (V2)

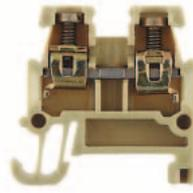

5.1 x 24.8 x 25
24 / 2.5
0.21 ... 2.5

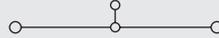

IEC 60947-7-1

EEx e II 2 G D

IEC	UL	CSA	EN 50019
250	150	300	175
17.5	15	10	10
1.5	AWG 22 ...14	AWG 24...16	1.5
		4 / 3	
		A1 / V2	



SIRA 02ATEX3001 U

Rated connection

0.5...2.5 / 1.5...1.5
0.5...1.5 / 0.5...1.5
0.4...0.6 (M 2.5)
7 / 3.0 x 0.5

AKZ 2.5

2.5 mm²

Modular feed-through terminal (V2)

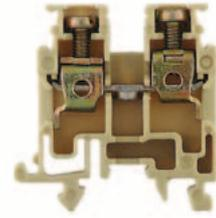

5.1 x 25.5 x 26.5
32 / 4
0.13 ... 4

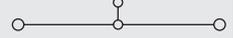

IEC 60947-7-1

EEx e II 2 G D

IEC	UL	CSA	EN 50019
250	300	300	175
24	10	10	15
2.5	AWG 22 ...12	AWG 26...12	2.5
		4 / 3	
		A3 / V2	



SIRA 02ATEX3001 U

Rated connection

0.5...4 / 1.5...2.5
0.5...2.5 / 0.5...2.5
0.4...0.6 (M 2.5)
7 / 3.0 x 0.5

0.5...1.5
0.5...1.5 / 0.5...1.5

0.5...1.5
0.5...1.5 / 0.5...1.5

Type	Qty	Order No.
AKZ 2.5	100	0697160000
AKZ 2.5 BL	100	0697180000

Type	Current [A]	Qty	Order No.
Q 2 AKZ1.5	24	50	0368200000
Q 3 AKZ1.5	24	50	0368300000
Q 4 AKZ1.5	24	50	0368400000
Q 10 AKZ1.5	24	50	0368500000

Type	Width [mm]	Qty	Order No.
AP AKZ2.5	2.5	50	0697360000
AP AKZ2.5 BL	2.5	50	0697380000
TW AKZ 2.5	0.5	20	0318560000
TW AKZ2.5 BL	0.5	20	0318580000

Type	Width [mm]	Qty	Order No.
EW 15	9.5	50	0382860000

STB 8.5/D4/2.3/M2.5 AKZ	50	0215700000
PS 2.3 RT	20	0180400000

DEK 5

Mini Modular Terminals

AKZ 4

4 mm²

Modular feed-through terminal (V2)

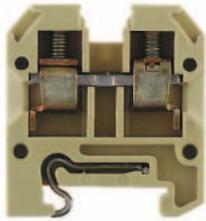

6.1 x 27 x 30.5

41 / 6

0.13 ... 6

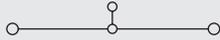

IEC 60947-7-1

EEx e II  II 2 G D

IEC	UL	CSA	EN 50019
400	300	300	275
32	27	10	21
4	AWG 22 ...12	AWG 24...12	4
6 / 3			
A3 / V2			



SIRA 02ATEX3001 U

Rated connection

0.5...6 / 1.5...4

0.5...4 / 0.5...4

0.6...0.8 (M 3)

8 / 3.5 x 0.6

0.5...1.5

0.5...1.5 / 0.5...1.5

Twin wire end ferrules ZH 0.5 - ZH 1.5

Type	Qty	Order No.
AKZ 4	100	0294360000
AKZ 4 BL	100	0294380000

Type	Current [A]	Qty	Order No.
Q 2 AKZ4	24	50	0336400000
Q 3 AKZ4	24	50	0336500000
Q 4 AKZ4	24	50	0336600000
Q 10 AKZ4	24	50	0368600000

Width [mm]			
AP AKZ4	1.5	20	0294460000
AP AKZ4 BL	1.5	20	0294480000
TW AKZ4	0.5	50	0348260000

Width [mm]			
EW 15	9.5	50	0382860000

STB 8.5/D4/2.3/M2.5 AKZ	50	0215700000
PS 2.3 RT	20	0180400000

DEK 6

SAKR

2.5 mm²

Modular disconnect test terminal



6.5 x 42 x 45

10 / 4

0.13 ... 4



IEC 60947-7-2

IEC	UL	CSA	EN 50019
400			
10			
4			
6 / 3			
A3 / V2			

Rated connection

0.5...4 / 1.5...4

0.5...4 / 0.5...4

0.5...1.0 (M 3)

7 / 3.0 x 0.5

0.5...1.5

0.5...1.5 / 0.5...1.5

QB 25, see chapter accessories.
Twin wire end ferrules ZH 0.5 - ZH 1.5

Type	Qty	Order No.
SAKR 15	100	0412760000
SAKR 15 2STB	100	0412860000

Type	Current [A]	Qty	Order No.
QB 2 insulated		50	0482700000
QB 3 insulated		50	0482800000
QB 4 insulated		50	0482900000
QB 25 uninsulated		20	0134000000

Width [mm]			
AP (1.5)		20	0211360000

Width [mm]			
EW 15	9.5	50	0382860000

PS 2.3	20	0180400000
--------	----	------------

DEK 6.5

Mini modular terminals

Modular PE terminals TS 15 / PA

When using ATEX certified components in hazardous area applications the installation instructions and the rated data for accessories in the technical appendix must be considered.

Width/Length/Height with TS 15	mm
Max. current / max. cond. cross-section	A/mm ²
Max. clamping range	mm ²

Technical data

Rated data	
Rated cross-section	mm ²
Rated voltage for adjacent terminal	V
Rated impulse voltage / Pollution severity	kV
Short-duration withstand current	A
Pollution severity	
Plug gauge IEC 60-947-1 / flammability class acc. UL 94	
Approvals	

Clampable conductors (H05V/H07V)	
Solid / stranded	mm ²
Flexible / flexible w. wire end ferrule	mm ²
Tightening torque range (clamping screw)	Nm
Tightening torque range (fixing screw)	Nm
Stripping length / blade size	mm / -

2 clampable conductors of equal cross-section	
Solid / stranded	mm ²
Flexible / flexible w. wire end ferrule	mm ²

Information

Order data

Version	
	green/yellow

Information

Accessories

Rail support	Type	Qty.	Order No.

Marking systems	Type	Qty.	Order No.
	DEK 5		

For detailed information on other accessories and applications see "Accessories"

AKE 2.5

2.5 mm²

Protective earth terminals

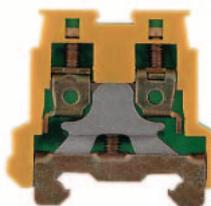

5.1 x 28 x 28	
/ 4	
0.13 ... 4	

IEC 60947-7-2 EEx e II II 2 G D

IEC	UL	CSA	EN 50019
2.5	AWG 22... 12	AWG 26... 12	2.5
250			
4			
	300 A (2.5 mm ²)		
	3		
	A3 / V2		

SIR A 02ATEX3001 U

Rated connection	Additional connection
0.5...4 / 1.5...2.5	
0.5...2.5 / 0.5...2.5	
0.4...0.6 (M 2.5)	
0.4...0.6 (M 2.5)	
7 / 3.0 x 0.5	

AKE 4 MS

4 mm²

PE terminal

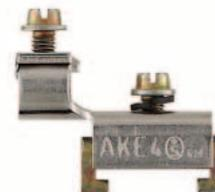

7 x 27.5 x 30	
/ 4	
0.5 ... 4	

IEC 60947-7-2

IEC	UL	CSA	EN 50019
4		AWG 22... 14	
	480 A (4 mm ²)		
	3		
	A3		

Rated connection	Additional connection
0.5...4 / 1.5...4	
0.5...4 / 0.5...4	
0.8...1.6 (M 3.5)	
0.8...1.6 (M 3.5)	
9 / 3.5 x 0.6	

Mini modular terminals

AKE 4

4 mm²

PE terminal



7 x 32 x 34.5

/ 4

0.13 ... 4

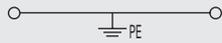

IEC 60947-7-2

EEx e II  II 2 G D

IEC	UL	CSA	EN 50019
4	AWG 22... 12	AWG 26... 12	4
500			
6			
	480 A (4 mm ²)		
	3		
	A3 / V2		



SIRA 02ATEX3001 U

Rated connection	Additional connection
0.5...4 / 1.5...4	
0.5...4 / 0.5...2.5	
0.5...1.0 (M 3)	
0.5...1.0 (M 3)	
9 / 3.5 x 0.6	

Type	Qty.	Order No.
AKE 4	100	0380260000

Type	Qty.	Order No.
DEK 6,5		

Mini modular terminals

With electronic components TS 15 / PA

AKZ 4 LD

4 mm²

DC voltage indicator

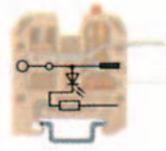

When using ATEX certified components in hazardous area applications the installation instructions and the rated data for accessories in the technical appendix must be considered.

Width/Length/Height with TS35x7.5	mm
Max. current / max. cond. cross-section	A/mm ²
Max. clamping range	mm ²

6 x 35.5 x 30
10 / 4
0.5 ... 4

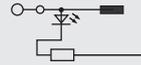

Technical data

Rated data	
Rated voltage	V
Rated current	A
Rated cross-section	mm ²
Rated impulse voltage / Pollution severity	kV/-
Plug gauge IEC 60-947-1 / flammability class acc. UL 94	
Approvals	

IEC	UL	CSA	EN 50019
24			
10			
4			
		1 / 3	
		A3 / V2	

Electronic built-in components

Diode current / diode voltage	V / A
voltage LED / current LED / polarity	V / mA / -
Resistance / Varistor	-/V

24 / 5

Clampable conductors (H05V/H07V)

Solid / stranded	mm ²
Flexible / flexible w. wire end ferrule	mm ²
Tightening torque range (clamping screw)	Nm
Stripping length / blade size	mm / -

Rated connection	Additional connection
0.5...4 / 0.5...4	
0.5...4 / 0.5...4	
0.5...0.8 (M 3)	
8 / 3.5 x 0.6	

Information

Conductor for solder connection max. 1.5 mm²

Order data

Version	
Terminal components	LED red
see circuit diagram above	LED green
	Neon lamp
	Neon lamp

Type	Spannung	Qty.	Order No.
AKZ 4 LD 24VDC	24 VDC	25	8022520000

Information

Accessories

Cross-connection, screwable	
	2-pole
	3-pole
	4-pole
(Q / QB)	10-pole

Type	Current [A]	Qty.	Order No.
Q 2 AKZ4	32	50	0336400000
Q 3 AKZ4	32	50	0336500000
Q 4 AKZ4	32	50	0336600000
Q 10 AKZ4	32	20	0368600000

External cross-connection	
	2-pole
	3-pole
	4-pole

Current [A]	

End plate	beige
------------------	-------

AP AKZ4	20	0294460000
---------	----	------------

Socket

STB 8.5/D4/2.3/M2.5 AKZ	50	0215700000
-------------------------	----	------------

Test plug

PS 2.3 RT	20	0180400000
-----------	----	------------

Connecting sleeve

VH 10/4/2.8 AKZ4	50	0446600000
------------------	----	------------

Cross-connection saddle

VL 2 AKZ4/DK4	50	0446700000
---------------	----	------------

Fixing screw / Partition disc	
Fixing screw	
Partition disc	

BFSC M2.5X14 SAKD2.5N	100	0266800000
-----------------------	-----	------------

Marking systems

DEK 6

For detailed information on other accessories and applications see "Accessories"

Mini modular terminals

Fuse terminals TS 15 / PA

ASK 1/15 **4 mm²**

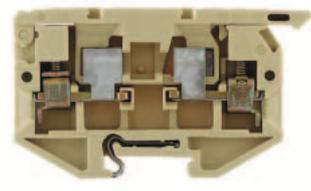

When using ATEX certified components in hazardous area applications the installation instructions and the rated data for accessories in the technical appendix must be considered.

Width/Length/Height with TS 15 mm
 Max. current / max. cond. cross-section A/mm²
 Max. clamping range mm²

8 x 58 x 34
6.3 / 4
0.13 ... 4



Technical data

Rated data	
Rated voltage for adjacent terminal	V
Rated current	A
Rated cross-section	mm ²
Rated impulse voltage / Pollution severity	kV/-
Plug gauge IEC 60-947-1 / flammability class acc. UL 94	
Approvals	

IEC	UL	CSA	EN 50019
500	300	300	
6.3	10	6.3	
4	AWG 22... 12	AWG 26... 12	
		6 / 3	
		A3 / V2	

Clamped conductor (H05V/H07V)	
Solid / stranded	mm ²
Flexible / flexible w. wire end ferrule	mm ²
Tightening torque range (clamping screw)	Nm
Stripping length / blade size	mm / -

Rated connection	Additional connection
0.5...4 / 1.5...4	
0.5...4 / 0.5...4	
0.5...1.0 (M 3)	
9 / 3.5 x 0.6	

2 clampable conductors of equal cross-section	
Solid / stranded	mm ²
Flexible / flexible w. wire end ferrule	mm ²

Information

Order data

Version	
	without LED

Type	Qty.	Order No.
ASK 1/15	100	0376860000

Information

Accessories

Cross-connection	
	2-pole
	3-pole
	4-pole
	10-pole
	Fuse cartridges
	Fixing screw

Type	Current [A]	Qty.	Order No.
QB 2 WI RA8 IS		50	0461100000
QB 3 WI RA8 IS		50	0461200000
QB 4 WI RA8 IS		50	0461300000

Screw cap	
	SK
	SK

Colour

Gauge pieces	

Colour

Fuse cartridges
Rated voltage 500V

Fuse cartridges
Rated voltage 400V

Marking systems
DEK 6,5

For detailed information on other accessories and applications see "Accessories"

Contact Sleeve order no. 0553300000;
 AP ASK 1 order no. 0380360000

Mini modular terminals

with push-on connection
TS 15 / PA

AKZ 4 SS SE 6.3/2.8

2.5 mm²

AKZ 4 SS WA 2x2.8

1 mm²

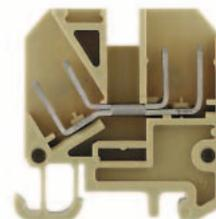

When using ATEX certified components in hazardous area applications the installation instructions and the rated data for accessories in the technical appendix must be considered.

Width/Length/Height with TS 15	mm
Max. current / max. cond. cross-section	A/mm ²
Max. clamping range	mm ²

6 x 28.45 x 30.5	
8 / 2.5	
0.2 ... 2.5	

6 x 28.5 x 30.5	
8 / 1	
0.2 ... 1	

Technical data

Rated data	
Rated voltage	V
Rated current	A
Rated cross-section	mm ²
Rated impulse voltage / Pollution severity	kV/-
Plug gauge IEC 60-947-1 / flammability class acc. UL 94	
Approvals	

IEC 60947-7-1 / IEC 61210			
IEC	UL	CSA	EN 50019
400	150	300	
8	10	10	
2.5	AWG 22... 12	AWG 24... 12	
		6 / 3	
		/ V2	

IEC 60947-7-1 / IEC 61210			
IEC	UL	CSA	EN 50019
400	150	300	
8	10	10	
1	AWG 22... 12	AWG 24... 12	
		6 / 3	
		/ V2	

Clampable conductors (H05V/H07V)	
Solid / stranded	mm ²
Flexible / flexible w. wire end ferrule	mm ²
Tightening torque range (clamping screw)	Nm
Stripping length / blade size	mm / -

Rated connection		Additional connection	

Rated connection		Additional connection	

2 clampable conductors of equal cross-section	
Solid / stranded	mm ²
Flexible / flexible w. wire end ferrule	mm ²

Information

Order data

Version	
	slotted
	Unslotted
	slotted blue
	Unslotted blue

Type	Qty.	Order No.
AKZ 4 SS SE 6.3/2.8	100	0324560000

Type	Qty.	Order No.
AKZ 4 SS WA 2X2.8	100	0362460000

Information

Accessories

Cross-connection	
	2-pole
	3-pole
	4-pole
	10-pole

Type	Current [A]	Qty.	Order No.
Q 2 AKZ4SS	20	50	0369000000
Q 3 AKZ4SS	20	50	0369100000
Q 4 AKZ4SS	20	50	0369200000
Q 10 AKZ4SS	20	20	0369300000

Type	Current [A]	Qty.	Order No.
Q 2 AKZ4SS	20	50	0369000000
Q 3 AKZ4SS	20	50	0369100000
Q 4 AKZ4SS	20	50	0369200000
Q 10 AKZ4SS	20	20	0369300000

Plug adapter	
	2-pole
	3-pole
	4-pole
	5-polig
	8-pole

Width [mm]			
AP AKZ4	1.5	20	0294460000
TW AKZ4	0.5	50	0348260000

Width [mm]			
AP AKZ4	1.5	20	0294460000
TW AKZ4	0.5	50	0348260000

Testing/Checking	
for testing	PS
wired terminal strips	StB

PS 2.3 RT	20	0180400000
STB 8.5/D4/2.3/M2.5 AKZ	50	0215700000

PS 2.3 RT	20	0180400000
STB 8.5/D4/2.3/M2.5 AKZ	50	0215700000

Insulating sleeve	
	2.8
	6.3

IH 2.8 DB	100	0386060000
IH 6.3 WEM GE	100	0386260000

IH 2.8 DB	100	0386060000
-----------	-----	------------

Marking systems

DEK 6

DEK 6

For detailed information on other accessories and applications see "Accessories"

Mini modular terminals

AKZ 4 S WA 2x2.8

4 mm²



6 x 27 x 30
8 / 4
0.2 ... 4

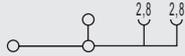

IEC 60947-7-1 / IEC 61210

IEC	UL	CSA	EN 50019
400	150	300	
8	20	10	
4	AWG 22... 12 AWG 24... 12		
	6 / 3		
	A3 / V2		



Rated connection	Additional connection
0.5...4 / 1.5...4	
0.5...4 / 0.5...2.5	
0.6...0.8 (M 3)	
8 / 3.5 x 0.6	

AKZ 4 SF SE 6.3/2.8

4 mm²

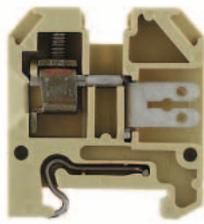

6 x 27 x 30
8 / 4
0.2 ... 4

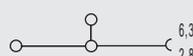

IEC 60947-7-1 / IEC 61210

IEC	UL	CSA	EN 50019
400		300	
8		10	
4	AWG 24... 12		
	6 / 3		
	A3 / V2		



Rated connection	Additional connection
0.5...4 / 1.5...4	
0.5...4 / 0.5...2.5	
0.6...0.8 (M 3)	
8 / 3.5 x 0.6	

Type	Qty.	Order No.
AKZ 4 S WA 2X2.8	100	0324460000

Type	Qty.	Order No.
AKZ 4 SF SE 6.3/2.8	100	0158760000

Type	Current [A]	Qty.	Order No.
Q 2 AKZ4	32	50	0336400000
Q 3 AKZ4	32	50	0336500000
Q 4 AKZ4	32	50	0336600000
Q 10 AKZ4	32	20	0368600000

Type	Current [A]	Qty.	Order No.
Q 2 AKZ4	32	50	0336400000
Q 3 AKZ4	32	50	0336500000
Q 4 AKZ4	32	50	0336600000
Q 10 AKZ4	32	20	0368600000

Width [mm]	Qty.	Order No.	
AP AKZ4	1.5	20	0294460000
TW AKZ4	0.5	50	0348260000

Width [mm]	Qty.	Order No.	
AP AKZ4	1.5	20	0294460000
TW AKZ4	0.5	50	0348260000

PS 2.3 RT	20	0180400000
STB 8.5/D4/2.3/M2.5 AKZ	50	0215700000

PS 2.3 RT	20	0180400000
STB 8.5/D4/2.3/M2.5 AKZ	50	0215700000

IH 2.8 DB	100	0386060000
-----------	-----	------------

IH 2.8 DB	100	0386060000
IH 6.3 WEM GE	100	0386260000

DEK 6

DEK 6

Mini modular terminals

with solder connection
TS 15 / PA

AKZ 1.5L VS

1.5 mm²

AKZ 4 L

4 mm²

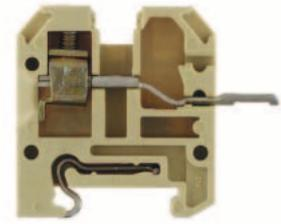

When using ATEX certified components in hazardous area applications the installation instructions and the rated data for accessories in the technical appendix must be considered.

Width/Length/Height with TS 15	mm
Max. current / max. cond. cross-section	A/mm ²
Max. clamping range	mm ²

5 x 34.5 x 25.5	
16 / 2.5	
0.2 ... 2.5	

6 x 35.5 x 30	
16 / 4	
0.2 ... 4	

Technical data

Rated data	
Rated voltage	V
Rated current	A
Rated cross-section	mm ²
Rated impulse voltage / Pollution severity	kV/-
Plug gauge IEC 60-947-1 / flammability class acc. UL 94	
Approvals	

IEC 60947-7-1 / IEC 60068-2-20

IEC	UL	CSA	EN 50019
250		150	
16		10	
1.5		AWG 24...16	
		4 / 3	
		A1 / V2	

IEC 60947-7-1 / IEC 60068-2-20

IEC	UL	CSA	EN 50019
250	300	300	
16	20	10	
4	AWG 22...12	AWG 24...12	
		4 / 3	
		A3 / V2	

Clampable conductors (H05V/H07V)	
Solid / stranded	mm ²
Flexible / flexible w. wire end ferrule	mm ²
Tightening torque range (clamping screw)	Nm
Stripping length / blade size	mm / -

Rated connection		Additional connection	
0.5...2.5...1.5			
0.5...1.5 / 0.5...1.5			
0.4...0.6 (M 2.5)			
7 / 3.0 x 0.5			

Rated connection		Additional connection	
0.5...4 / 1.5...4			
0.5...4 / 0.5...2.5			
0.6...0.8 (M 3)			
8 / 3.5 x 0.6			

2 clampable conductors of equal cross-section	
Solid / stranded	mm ²
Flexible / flexible w. wire end ferrule	mm ²

Information

Order data

Version
beige
blue

Type	Qty.	Order No.
AKZ 1.5L VS	100	0340160000

Type	Qty.	Order No.
AKZ 4L SL VS	100	0334860000
AKZ 4L SL VS BL	100	0334880000

Information

Accessories

Cross-connection, screwable	
	(Q)
2-pole	
3-pole	
4-pole	
10-pole	
Connecting sleeve	
Fixing screw	
Fuse cartridges	

Type	Current [A]	Qty.	Order No.
Q 2 AKZ1.5		50	0368200000
Q 3 AKZ1.5	24	50	0368300000
Q 4 AKZ1.5	24	50	0368400000
Q 10 AKZ1.5	24	20	0368500000

Type	Current [A]	Qty.	Order No.
Q 2 AKZ4	32	50	0336400000
Q 3 AKZ4	32	50	0336500000
Q 4 AKZ4	32	50	0336600000
Q 10 AKZ4	32	20	0368600000

Cross-connection saddle	
Cross-connection saddle	
Connecting sleeve	
Fixing screw	

Type	Current [A]	Qty.	Order No.
VL 2 AKZ4/DK4		50	0446700000
VH 10/4/2.8 AKZ4		50	0446600000
BFSC M2.5X14 SAKD2.5N		100	0266800000

Type	Current [A]	Qty.	Order No.
STB 8.5/D4/2.3/M2.5 AKZ		50	0215700000
PS 2.3 RT		20	0180400000

Socket / Test plug	
Socket	
Test plug	

Type	Current [A]	Qty.	Order No.
STB 8.5/D4/2.3/M2.5 AKZ		50	0215700000
PS 2.3 RT		20	0180400000

Type	Current [A]	Qty.	Order No.
AP AKZ4	1.5	20	0294460000

End plate	
beige	
blue	

Type	Current [A]	Qty.	Order No.
AP AKZ1.5W	1.5	20	0329660000

Type	Current [A]	Qty.	Order No.
AP AKZ4	1.5	20	0294460000

Partition / Partition disc	
beige	
blue	
Partition disc	

Type	Current [A]	Qty.	Order No.
TW AKZ4 HP/DBR/0.5	0.5	50	0166800000

Type	Current [A]	Qty.	Order No.
TW AKZ4	0.5	50	0348260000
TSCH 4 AKZ4	6	100	0363360000

Cover / fixing screw (plastic)	
Cover	
Fixing screw (plastic)	

Type	Current [A]	Qty.	Order No.
AD 4 AKZ4		50	0303400000
BFSC M2.5X18 PA/RT		100	0303300000

Type	Current [A]	Qty.	Order No.
AD 4 AKZ4		50	0303400000
BFSC M2.5X18 PA/RT		100	0303300000

Marking systems	
DEK 5	

Type	Current [A]	Qty.	Order No.
DEK 5			

Type	Current [A]	Qty.	Order No.
DEK 6			

Detailed information on all versions in chapter accessories.

Mini modular terminals

AKZ 4 LL VS

1.5 mm²

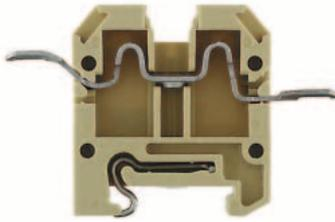

6 x 44 x 30
16 / 1.5
0.2 ... 1.5

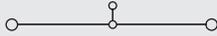

IEC 60947-7-1 / IEC 60068-2-20

IEC	UL	CSA	EN 50019
250	300	300	
16	20	10	
1.5	AWG 22...12	AWG 24...12	
	4 / 3		
	/ V2		



Rated connection	Additional connection
0.5...1.5 / 0.5...1.5	
0.5...1.5	

ADK 1

4 mm²

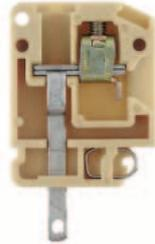

6 x 22 x 36.5
16 / 4
0.13 ... 4



IEC	UL	CSA	EN 50019
400	300	300	
16	10	15	
4	AWG 26...12	AWG 26...12	
	6 / 3		
	A3 / V2		

Rated connection	Additional connection
0.5...4 / 1.5...2.5	
0.5...4 / 0.5...2.5	
0.5...1.0 (M3)	
9 / 3.5 x 0.6	

Type	Qty.	Order No.
AKZ 4 LL VS	100	0346460000

Type	Qty.	Order No.
ADK 1/1.5	100	0303860000
ADK 1/1.5 BL	100	0303880000

Type	Current [A]	Qty.	Order No.
Q 2 AKZ4	32	50	0336400000
Q 3 AKZ4	32	50	0336500000
Q 4 AKZ4	32	50	0336600000
Q 10 AKZ4	32	20	0368600000

Type	Current [A]	Qty.	Order No.

VL 2 AKZ4/DK4	50	0446700000
VH 10/4/2.8 AKZ4	50	0446600000
BFSC M2.5X14 SAKD2.5N	100	0266800000

STB 8.5/D4/2.3/M2.5 AKZ	50	0215700000
PS 2.3 RT	20	0180400000

Width [mm]			
AP AKZ4	1.5	20	0294460000

Width [mm]			
TW AKZ4	0.5	50	0348260000

AD 4 AKZ4	50	0303400000
BFSC M2.5X18 PA/RT	100	0303300000

DEK 6		
-------	--	--

PS 2.3 RT	20	0180400000
-----------	----	------------

Width [mm]			
AP ADK1		50	0476260000

Width [mm]			
TW ADK1 HP/DBR/0.5	0.5	50	0442300000

DEK 6		
-------	--	--

Mini modular terminals

with solder connection
TS 15 / PA & KRG

AKZ 4 L KRG

4 mm²

AL 1

1 mm²

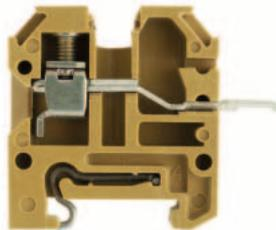

When using ATEX certified components in hazardous area applications the installation instructions and the rated data for accessories in the technical appendix must be considered.

Width/Length/Height with TS 15	mm
Max. current / max. cond. cross-section	A/mm ²
Max. clamping range	mm ²

6 x 35.5 x 30	
16 / 4	
0.2 ... 4	

6.5 x 32 x 21	
13.5 / 1	
0.5 ... 1	

Technical data

Rated data	
Rated voltage	V
Rated current	A
Rated cross-section	mm ²
Rated impulse voltage / Pollution severity	kV/-
Plug gauge IEC 60-947-1 / flammability class acc. UL 94	
Approvals	

IEC 60947-7-1 / IEC 60068-2-20			
IEC	UL	CSA	EN 50019
250	300	300	
16	20	10	
4	AWG 22...12	AWG 24...12	
		4 / 3	
		A3 / 5VA	

IEC 60947-7-1 / IEC 60068-2-20			
IEC	UL	CSA	EN 50019
400			
13.5			
1			
		6 / 3	
		/ 5VA	

Rated connection		Additional connection	
0.5...4	/ 1.5...4		
0.5...4	/ 0.5...2.5		
0.6...0.8	(M 3)		
8	/ 3.5 x 0.6		

Rated connection		Additional connection	
0.5...1			
0.5...1			

Clampable conductors (H05V/H07V)	
Solid / stranded	mm ²
Flexible / flexible w. wire end ferrule	mm ²
Tightening torque range (clamping screw)	Nm
Stripping length / blade size	mm / -

2 clampable conductors of equal cross-section	
Solid / stranded	mm ²
Flexible / flexible w. wire end ferrule	mm ²

Information

Order data

Version	
	beige
	blue

Information

Type	Qty.	Order No.
AKZ 4L SL VS KRG	100	0334820000

Type	Qty.	Order No.
AL 1	100	0137320000

Accessories

Cross-connection, screwable	
	2-pole
	3-pole
	4-pole
	10-pole
Connecting sleeve	
Fixing screw	
Fuse cartridges	

Type	Current [A]	Qty.	Order No.
Q 2 AKZ4	32	50	0336400000
Q 3 AKZ4	32	50	0336500000
Q 4 AKZ4	32	50	0336600000
Q 10 AKZ4	32	20	0368600000

Type	Current [A]	Qty.	Order No.

Cross-connection saddle			
Cross-connection saddle	VL 2 AKZ4/DK4	50	0446700000
Connecting sleeve	VH 10/4/2.8 AKZ4	50	0446600000
Fixing screw	BFSC M2.5X14 SAKD2.5N	100	0266800000

Socket / Test plug			
Socket	STB 8.5/D4/2.3/M2.5 AKZ	50	0215700000
Test plug	PS 2.3 RT	20	0180400000

End plate				
beige	AP AKZ4	1.5	20	0294460000
blue				

Width [mm]			
EP AL1 HP/DBR/1	1	100	0164100000

Partition / Partition disc				
beige	TW AKZ4	0.5	50	0348260000
blue				
Partition disc	TSCH 4 AKZ4	6	100	0363360000

Width [mm]			
TW AKZ4 HP/DBR/0.5	0.5	50	0166800000

Cover / fixing screw (plastic)			
Cover	AD 4 AKZ4	50	0303400000
Fixing screw (plastic)	BFSC M2.5X18 PA/RT	100	0303300000

Marking systems

Detailed information on all versions in chapter accessories.

DEK 6

DEK 6,5

Mini modular terminals

AKA 2.5

2.5 mm²



6 x 20 x 31
 20 / 2.5
 0.13 ... 2.5

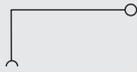

IEC	UL	CSA	EN 50019
400	300	300	
20	20	10	
2.5	AWG 20...12	AWG 24...12	
	6 / 3		
	A3 / V-0		



Rated connection	Additional connection
0.5...2.5 / 1.5...2.5	
0.5...2.5 / 0.5...1.5	
0.4 (M 2.5)	
9 / 3.5 x 0.6	

Type	Qty.	Order No.
AKA 2.5	100	0300720000
AKA 2.5 BL	100	0300770000

Type	Current [A]	Qty.	Order No.
Width [mm]			
AP AKA2.5		100	0162520000
AP AKA2.5 KRG/BL		50	0162570000
Width [mm]			

DEK 6



Mini modular terminals

with Termini-Point/Wire-Wrap connection
TS 15 / PA

AKZ 1.5 T

1.5 mm²

AKZ 4 T

4 mm²



When using ATEX certified components in hazardous area applications the installation instructions and the rated data for accessories in the technical appendix must be considered.

Width/Length/Height with TS 15	mm
Max. current / max. cond. cross-section	A/mm ²
Max. clamping range	mm ²

5 x 24.8 x 44.9	
8 / 2.5	
0.2 ... 2.5	

6 x 27	
10 / 4	
0.2 ... 4	

Technical data

Rated data	
Rated voltage	V
Rated current	A
Rated cross-section	mm ²
Rated impulse voltage / Pollution severity	kV/-
Plug gauge IEC 60-947-1 / flammability class acc. UL 94	
Approvals	

IEC 60947-7-1 / VDE 41611-4			
IEC	UL	CSA	EN 50019
125	300	300	
8	10	10	
1.5	AWG 26... 14	AWG 24... 16	
		3 / 3	
		A1 / V2	

IEC 60947-7-1 / VDE 41611-4			
IEC	UL	CSA	EN 50019
250	300	300	
10	10	10	
4	AWG 26... 14	AWG 24... 12	
		4 / 3	
		A3 / V2	

Clampable conductors (H05V/H07V)	
Solid / stranded	mm ²
Flexible / flexible w. wire end ferrule	mm ²
Tightening torque range (clamping screw)	Nm
Stripping length / blade size	mm / -

Rated connection		Additional connection	
0.5...2.5 / 1.5			
0.5...1.5 / 0.5...1.5			
0.4...0.6 (M 2.5)			
7 / 3.0 x 0.5			

Rated connection		Additional connection	
0.5...4 / 1.5...4			
0.5...4 / 0.5...2.5			
0.6...0.8 (M 3)			
8 / 3.5 x 0.6			

2 clampable conductors of equal cross-section	
Solid / stranded	mm ²
Flexible / flexible w. wire end ferrule	mm ²

Information

Order data

Version	
right	
horizontal right	
vertical right	
2 x vertical	
left	
vertical left	

Type	Qty.	Order No.
AKZ 1.5 SW 1X1	100	0357960000

Type	Qty.	Order No.
AKZ 4 SW 1X1	100	0445860000

Information

Accessories

Cross-connection output-side (screwable)	
	2-pole
	3-pole
	4-pole
	10-pole

Type	Current [A]	Qty.	Order No.
Q 2 AKZ1.5	24	50	0368200000
Q 3 AKZ1.5	24	50	0368300000
Q 4 AKZ1.5	24	50	0368400000
Q 10 AKZ1.5	24	20	0368500000

Type	Current [A]	Qty.	Order No.
Q 2 AKZ4	32	50	0336400000
Q 3 AKZ4	32	50	0336500000
Q 4 AKZ4	32	50	0336600000
Q 10 AKZ4	32	20	0368600000

End plate / partition	
End plate	
End plate blue	
Partition	
Partition	
Partition disc	

Type	Current [A]	Qty.	Order No.
AP AKZ1.5	1.5	50	0340560000

Type	Current [A]	Qty.	Order No.
AP AKZ4	1.5	20	0294460000

External cross-connection	
2-pole	
3-pole	
4-pole	

Width [mm]	

Width [mm]	

Cover	
Cover	
Plombierschraube	

Cover	

Cover	

Testing/Checking	
for testing	PS
wired terminal strips	StB

Type	Qty.	Order No.
PS 2.3 RT	20	0180400000
STB 8.5/D4/2.3/M2.5 AKZ	50	0215700000

Type	Qty.	Order No.
PS 2.3 RT	20	0180400000
STB 8.5/D4/2.3/M2.5 AKZ	50	0215700000

Marking systems	

Marking systems	
DEK 5	

Marking systems	
DEK 6	

For detailed information on other accessories and applications see "Accessories"

Mini modular terminals

AKZ 2.5K

2.5 mm²



5 x 29 x 46

8 / 5.3

0.13 ... 5.3

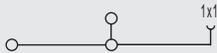

IEC	UL	CSA	EN 50019
250	300	300	
8	10	10	
2.5	AWG 22... 12	AWG 26... 10	
	4 / 3		
	A2 / V2		



Rated connection	Additional connection
0.5...2.5 / 1.5...2.5	
0.5...2.5 / 0.5...2.5	
0.4...0.6 (M 2.5)	
7 / 3.0 x 0.5	

Type	Qty.	Order No.
AKZ 2.5 K SW U/V 1X1	100	0108960000

Type	Current [A]	Qty.	Order No.
AP AKZ2.5K	3	50	0697260000
TW AKZ2.5	0.5	20	0318560000

Width [mm]		
PS 2.3 RT	20	0180400000
STB 8.5/D4/2.3/M2.5 AKZ	50	0215700000

DEK 5



Content

--

For direct mounting	
Screw connection	F.2 - F.5
Screw connection, ATEX approval	F.6 - F.7

For direct mounting

Screw connection

MK 2/12

2.5 mm²

MK 3/2 ... 12

2.5 mm²

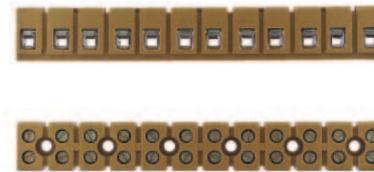
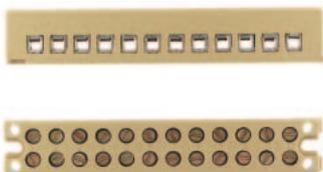

Width x height / ø fixing hole (length and mounting size: see order data)	mm
Max. clamping range	mm ²

15.0 x 15.0 / 3.20

0.21 ... 4.0

15.0 x 16.1 / 3.45

0.21 ... 4.0

Technical data

Rating data	
Rated voltage	V
Rated current	A
Rated cross-section	mm ²
Rated surge voltage / pollution severity	kV/-
Plug gauge acc. to IEC 60-947-1/ flammability class UL 94	
Approvals	

IEC-60-947-7-1

	IEC	UL	CSA
Rated voltage	125	300	300
Rated current	24	10	10
Rated cross-section	2.5	24..12 AWG	24..12 AWG
Rated surge voltage / pollution severity		2.5 / 3	
Plug gauge acc. to IEC 60-947-1/ flammability class UL 94		A2 / V2	



IEC-60-947-7-1

	IEC	UL	CSA
Rated voltage	400	300	300
Rated current	24	25	25
Rated cross-section	2.5	22..12 AWG	22..12 AWG
Rated surge voltage / pollution severity		6 / 3	
Plug gauge acc. to IEC 60-947-1/ flammability class UL 94		A2 / 5VA	



Clamping conductor H05V/H07V)

Solid / stranded	mm ²
Flexible / flexible with wire end ferrules	mm ²
Tightening torque range	Nm
Stripping length / clamping screw / blade size	mm

0.5...4 / 1.5...2.5
0.5...2.5 / 0.5...1.5
0.4...0.45
5 mm / M 2.5 / 3.5 x 0.6 mm

0.5...4 / 1.5...2.5
0.5...2.5 / 0.5...1.5
0.4...0.45
5 mm / M 2.5 / 3.5 x 0.6 mm

Notes

Order data

Version	Type	Length/mounting size mm	Qty	Order no.
2-pole				
3-pole				
4-pole				
5-pole				
6-pole				
7-pole				
8-pole				
9-pole				
10-pole				
12-pole	MK 2/12	86.00 / 80.0	50	0241260000
14-pole				
16-pole				

Type	Length/mounting size mm	Qty	Order no.
MK 3/2	17.40 / 18.5	100	0273820000
MK 3/3	26.50 / 18.5	50	0273920000
MK 3/4	35.75 / 18.5	50	0274020000
MK 3/5	45.00 / 18.5	50	0274120000
MK 3/6	54.25 / 37.0	50	0274220000
MK 3/7	63.50 / 37.0	50	0274320000
MK 3/8	72.75 / 55.5	25	0274420000
MK 3/9	82.00 / 55.5	25	0274520000
MK 3/10	91.25 / 74.0	20	0274620000
MK 3/12	110.00 / 92.5	20	0243520000

Type	Length/mounting size mm	Qty	Order no.
MK 3/2	17.40 / 18.5	100	0273820000
MK 3/3	26.50 / 18.5	50	0273920000
MK 3/4	35.75 / 18.5	50	0274020000
MK 3/5	45.00 / 18.5	50	0274120000
MK 3/6	54.25 / 37.0	50	0274220000
MK 3/7	63.50 / 37.0	50	0274320000
MK 3/8	72.75 / 55.5	25	0274420000
MK 3/9	82.00 / 55.5	25	0274520000
MK 3/10	91.25 / 74.0	20	0274620000
MK 3/12	110.00 / 92.5	20	0243520000

Notes

Accessories

Split rivet	Type	Qty	Order no.
	SN	500	0200100000
Solder bar	MF 2/12		0241760000
Tag strip	printed	BSTb 28/12 bottom	50 0245700000
		BSTb 28/12 top	50 0278500000
	not printed	BSTo 28/12	50 0245600000

Type	Qty	Order no.
BSTb 28/12	50	0245900000
BSTb 28/8	50	0290200000
BSTb 28/6	50	0290000000
BSTb 28/4	50	0289800000
BSTo 28/12	50	0245800000
BSTo 28/8	50	0284700000
BSTo 28/6	50	0289500000
BSTo 28/4	50	0289300000

Type	Qty	Order no.
BSTb 28/12	50	0245900000
BSTb 28/8	50	0290200000
BSTb 28/6	50	0290000000
BSTb 28/4	50	0289800000
BSTo 28/12	50	0245800000
BSTo 28/8	50	0284700000
BSTo 28/6	50	0289500000
BSTo 28/4	50	0289300000

For direct mounting

MK 4/16

2.5 mm²

MK 6/2 ... 6/6

6.0 mm²

MK 10/14

2.5 mm²

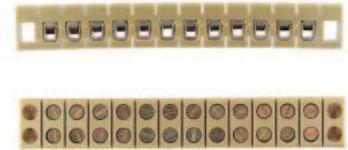

17.0 x 16.0 / 3.40

0.21 ... 4.0

IEC-60-947-7-1

IEC	UL	CSA
400	150	150
24	20	15
2.5	22...12 AWG	22...12 AWG
	6 / 3	
	A2 / 5VA	



0.5...4 / 1.5...2.5

0.5...2.5 / 0.5...1.5

0.4...0.45

8 mm / M 2.5 / 3.5 x 0.6 mm

23 x 22 / 3.4

0.33 ... 6.0

IEC-60-947-7-1

IEC	UL	CSA
690	300	300
41.0	30	40
6.0	22...10 AWG	22...10 AWG
	8 / 3	
	A3 / V2	



0.5...6 / 1.5...6

0.5...6 / 0.5...4

1.2...2.0

9 mm / M 4 / 4.0 x 0.8 mm

13.5 x 12 / 3.1

0.21 ... 4.0

IEC-60-947-7-1

IEC	UL	CSA
125	150	300
24	25	10
2.5	22...12 AWG	24...12 AWG
	2.5 / 3	
	A2 / V2	



0.5...4 / 1.5...2.5

0.5...2.5 / 0.5...1.5

0.4...0.45

6 mm / M 2.5 / 3.5 x 0.6 mm

Mounted by gluing or with M3x12 screws. Through the empty terminal point chamber

Type	Length/mounting size mm	Qty	Order no.
MK 4/16	103.00 / 85.5	20	0244220000

Type	Length/mounting size mm	Qty	Order no.
MK 6/2	23.5 / -	50	0620420000
MK 6/3	36.5 / 13.0	50	0620320000
MK 6/4	49.5 / 26.0	20	0620220000
MK 6/6	75.5 / 52.0	20	0620120000

Type	Length/mounting size mm	Qty	Order no.
MK 10/14	88.5 / -	20	0370160000

Other pole numbers available on request

Type	Qty	Order no.
BSTb 28/16 bottom	50	0262200000
BSTb 28/16 top	50	0278700000
BSTo 28/16	50	0262100000

Type	Qty	Order no.
BSTb 28/6	50	0304600000

Type	Qty	Order no.
------	-----	-----------

For direct mounting

Screw connection

MK 5/2 o. DE
2.5 mm²
KS 2 ... 10
2.5 mm²

Width x height / ϕ fixing hole mm
 (length and mounting size: see order data)
 Max. clamping range mm²

18.0 x 14.2 / 4.2
25.0 x 17.5 / 4.2
0.21 ... 4.0
0.21 ... 4.0

Technical data

Rating data

Rated voltage V
 Rated current A
 Rated cross-section mm²
 Rated surge voltage / pollution severity kV/-
 Plug gauge acc. to IEC 60-947-1/ flammability class UL 94 Approvals

	IEC	UL	CSA
Rated voltage	500		
Rated current	24		
Rated cross-section	2.5		
Rated surge voltage / pollution severity	6 / 3		
Plug gauge acc. to IEC 60-947-1/ flammability class UL 94	A2 / 5 VA		

	IEC	UL	CSA
Rated voltage	500	300	300
Rated current	24	20	25
Rated cross-section	2.5	22...12 AWG	24...12 AWG
Rated surge voltage / pollution severity		6 / 3	
Plug gauge acc. to IEC 60-947-1/ flammability class UL 94		A2 / 5VA	



Clamping conductor H05V/H07V)

Solid / stranded mm²
 Flexible / flexible with wire end ferrules mm²
 Tightening torque range Nm
 Stripping length / clamping screw / blade size mm

Solid / stranded	0.5...4 / 1.5...2.5
Flexible / flexible with wire end ferrules	0.5...2.5 / 0.5...1.5
Tightening torque range	0.4...0.45
Stripping length / clamping screw / blade size	5 mm / M 2.5 / 3.5 x 0.6 mm

Solid / stranded	0.5...4 / 1.5...2.5
Flexible / flexible with wire end ferrules	0.5...2.5 / 0.5...1.5
Tightening torque range	0.5...0.7
Stripping length / clamping screw / blade size	8 mm / M 3 / 4.0 x 0.8 mm

Notes

Order data

Version

2-pole
3-pole
4-pole
5-pole
6-pole
7-pole
8-pole
9-pole
10-pole
12-pole
14-pole
16-pole

Type	Length/mounting size mm	Qty	Order no.
MK 5/2	40 / 32	100	0243820000

Type	Length/mounting size mm	Qty	Order no.
KS 2	42 / 32	100	0134420000
KS 4	66 / 56	50	0140320000
KS 6	90 / 80	50	0140620000
KS 10	138 / 128	20	0141620000

Notes

Accessories

Split rivet

Type	Qty	Order no.
D2 MK 5/2		0244060000

Type	Qty	Order no.
D2 KS2 TP	100	0134500000
D4 KS4 TP	50	0140500000
D6 KS6 TP	50	0140800000
D10 KS 10 TP	20	0141800000

Cover



Tag strip

printed

not printed

ELsB 2	50	0143200000
ELsB 4	50	0143300000
ELsB 6	50	0143400000
ELsB 10	50	0143500000
ELsO 2	50	0142800000
ELsO 4	50	0142900000
ELsO 6	50	0143000000
ELsO 10	50	0143100000

For direct mounting

BK 2...12

4.0 mm²

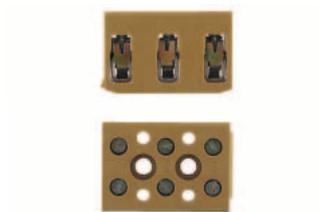

22 x 20 / 3.40

0.33 ... 4.0

IEC	UL	CSA
400	300	300
32.0	10	10
4.0	22..12 AWG	22..12 AWG
	6 / 3	
	A3 / 5VA	



0.5...4 / 1.5...4

0.5...4 / 0.5...4

0.5...0.7

8 mm / M 3 / 4.0 x 0.8 mm

Type	Length/mounting size mm	Qty	Order no.
BK 2CRN	20 / -	100	0624720000
BK 3CRN	31 / 11.0	100	0624920000
BK 4CRN	38 / 18.0	100	0625120000
BK 6CRN	52 / 32.0	50	0625220000
BK12 CRN	92 / 72.5	25	0625320000

Type	Qty	Order no.
SN	500	0200100000
BSTb 28/2	50	0203600000
BSTb 28/3	50	0203800000
BSTb 28/4	50	0197300000
BSTb 28/6	50	0197500000
BSTb 28/12	50	0198800000
BSTo 28/2	50	0203500000
BSTo 28/3	50	0203700000
BSTo 28/4	50	0197200000
BSTo 28/6	50	0197400000
BSTo 28/12	50	0198700000

For direct mounting

Screw connection

BK 2...12/E

4.0 mm²

MK 3/2...12/E

2.5 mm²

ATEX approval

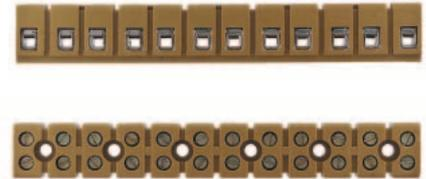
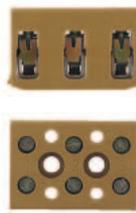

Width x height / ø fixing hole mm
(length and mounting size: see order data)
Max. clamping range mm²

22 x 20 / 3.40

15 x 16.1 x 3.45

0.33 ... 4.0

0.214

Technical data

Rating data

Rated voltage	V
Rated current	A
Rated cross-section	mm ²
Rated surge voltage / pollution severity	kV/-
Plug gauge acc. to IEC 60-947-1/ flammability class UL 94	
Approvals	

IEC	UL	CSA	EN 50019
400	300	300	275
32.0	10	10	21
4.0	22 ...2 AWG	22 ...12 AWG	4.0
6 / 3			
A3 / 5VA			
		SIRA 01ATEX3274U	

IEC	UL	CSA	EN 50019
400	300	300	275
24	25	25	15
2.5	22 ...12 AWG	22 ...12 AWG	2.5
6 / 3			
A2 / 5VA			
		SIRA 01ATEX3248U	

Clamping conductor H05V/H07V

Solid / stranded	mm ²
Flexible / flexible with wire end ferrules	mm ²
Tightening torque range	Nm
Stripping length / clamping screw / blade size	mm

0.5...4 / 1.5...4
0.5...4 / 0.5...4
0.5...0.7
8 mm / M 3 / 4.0 x 0.8 mm

0.5...4 / 1.5...2.5
0.5...2.5/ 0.5...1.5
0.4...0.6
5 mm / M 2.5/ 3.5x 0.6 mm

Notes

Order data

Version

Type	Length/mounting size mm	Qty	Order no.	
2-pole	BK 2/E	20 / -	100	7906040000
3-pole	BK 3/E	31 / 11.0	100	7906060000
4-pole	BK 4/E	38 / 18.0	100	7906080000
5-pole				
6-pole	BK 6/E	52 / 32.0	50	7906090000
7-pole				
8-pole				
9-pole				
10-pole				
11-pole				
12-pole	BK 12/E	92 / 72.5	25	7906100000

Type	Length/mounting size mm	Qty	Order no.
MK 3/2/E	17.40 / 18.50	100	7906110000
MK 3/3 E	26.50 / 18.50	100	7906120000
MK 3/4/E	35.75 / 18.50	50	7906130000
MK 3/5/E	45.00 / 18.50	50	7906140000
MK 3/6/E	54.25 / 37.00	50	7906150000
MK 3/7/E	63.50 / 37.00	25	7906160000
MK 3/8/E	72.75 / 55.50	25	7906170000
MK 3/9/E	82.00 / 55.50	25	7906180000
MK 3/10/E	91.25 / 74.00	25	7906190000
MK 3/11/E	100.50 / 74.00	25	7906200000
MK 3/12/E	110.00 / 92.50	25	7906210000

Notes

Accessories

Split rivet

Type	Qty	Order no.
SN	500	0200100000

Type	Qty	Order no.

Tag strip

Type	Qty	Order no.	
printed	BSTb 28/2	50	0203600000
	BSTb 28/3	50	0203800000
	BSTb 28/4	50	0197300000
	BSTb 28/6	50	0197500000
	BSTb 28/12	50	0198800000
not printed	BSTo 28/2	50	0203500000
	BSTo 28/3	50	0203700000
	BSTo 28/4	50	0197200000
	BSTo 28/6	50	0197400000
	BSTo 28/12	50	0198700000

For direct mounting

MK 6/2 ... 6/E

6.0 mm²



23 x 22 / 3.40

0.21 ... 6

IEC	UL	CSA	EN 50019
690	300	300	420
41.0	30	40	26
6.0	22..10 AWG	22..10 AWG	6.0
8 / 3			
A3 / V0			



SIRA 01ATEX3249U

0.5...6 / 1.5...6

0.5...6 / 0.5...4

1.2...2.0

9 mm / M 4 / 4.0 x 0.8 mm

Type	Length/mounting size mm	Qty	Order no.
MK 6/2/E	23.50 / -	50	7906220000
MK 6/3/E	36.50 / 13.00	50	7906230000
MK 6/4/E	49.50 / 26.00	20	7906240000
MK 6/5/E	62.50 / 26.00	20	7906250000
MK 6/6/E	75.50 / 52.00	20	7906260000

Type	Qty	Order no.
BSTb 28/6	50	0304600000

Content

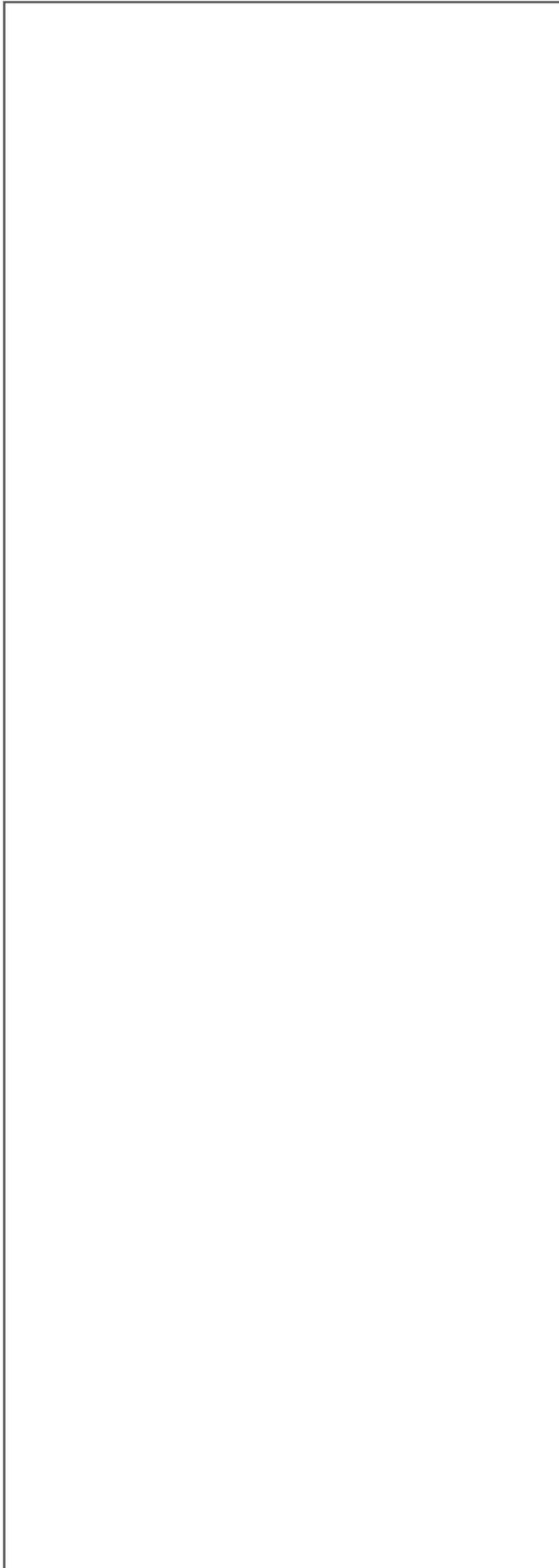

Overview	
	G.2 - G.3
For 10 x 3 mm busbars	
Clamping yoke	G.4 - G.5
Busbarholders	G.6 - G.7
Mounting directly on metal plate	
Clamping yoke	G.8
Busbar holder, Spacer	G.9
Mounting on TS 35	
FM 4-foot / Clamping yoke holder	G.10
For C-profiles	
Clamping yoke	G.11

The theoretical concept

Part 1 of the VDE 0133 standard specifies the required equipotential bonding for the electrical components of a machine. The aim is to prevent any undesirable consequences occurring as a result of electrostatic, electromagnetic and mains faults.

The following measures serve this purpose:

- Using filters and delay devices.
- Dividing reference potential into “dirty” and “clean”.
- Neutral earthing of all reference potential with large cross-section (> 6 mm²).
- Keeping all bonding leads as short as possible.
- Routing all connections parallel to the bonding surface.
- Using screened lines and, if possible, earthing the shield at both ends.
- Isolating and screening switchgear and components susceptible to interference.

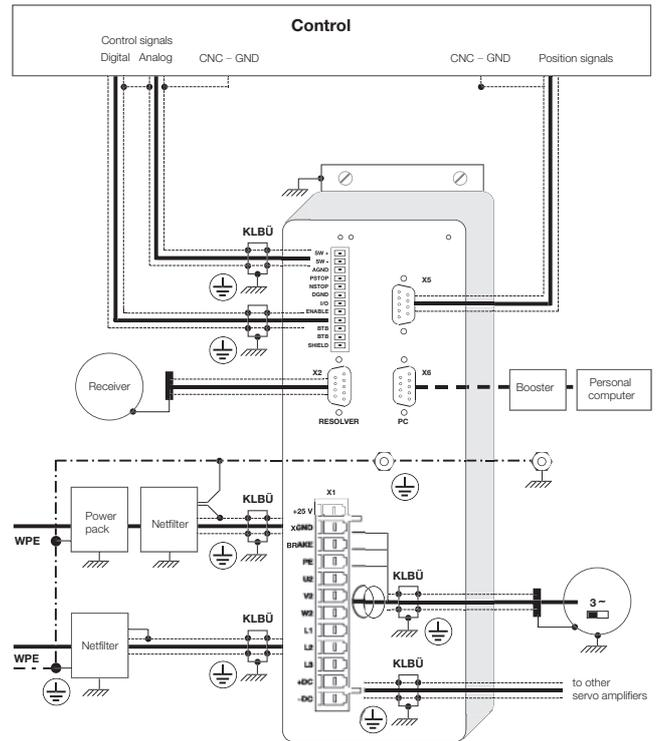

G

Overview of the available KLBÜs

For busbars
10 x 3

For direct mounting

For C-profiles

For TS 35
insulating/conducting

Clip-on for
10 x 3 busbar



In detail

Compression spring

To ensure both simple handling and proper connection, with permanent contact pressure as a result of the spring effect



No extra tools necessary

Simply **swivel onto the busbar by hand** – retrospectively if necessary

Full range

For conductors from 2 to 37 mm diameter

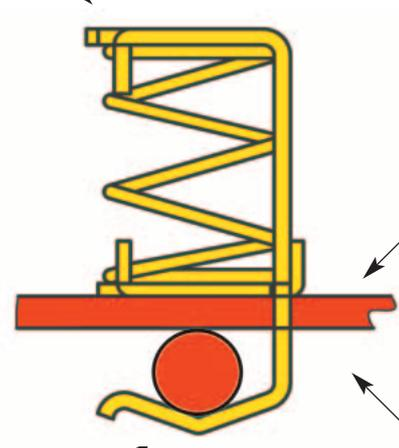

Reliable contact

Changes in diameter (flow) of the conductor compensated for by the elastic behaviour of the clamping yoke for flexible adjustment to the cable diameter

Many options available

Weidmüller offers a wide range of different fastenings for mounting shield connection terminals

For 10 x 3 mm busbars

Clamping yoke

Cable fastened against the busbar from below

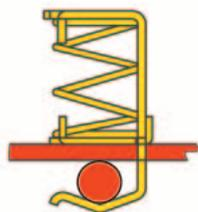

KLBÜ 2x2-6



KLBÜ 3-8



KLBÜ 4-13.5



KLBÜ 10-20



KLBÜ 15 - 32

G

KLBÜ

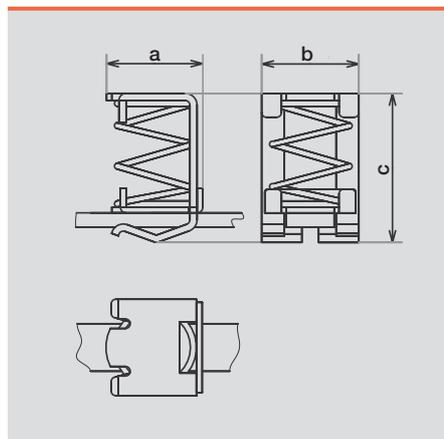

Order data

Type	for cable diameter	Dimensions (a x b x c) mm	Qty	Order no.
KLBÜ 2 x 2-6	2.0 ... 6.0 mm	15.0 x 18.0 x 24.0	10	1675350000
KLBÜ 3-8	3.0 ... 8.0 mm	13.0 x 18.0 x 26.0	10	1600480000
KLBÜ 4 x 13.5	4.0 ... 13.5 mm	20.0 x 20.5 x 31.5	10	1592810000
KLBÜ 10-20	10.0 ... 20.0 mm	25.0 x 26.0 x 40.0	10	1600490000
KLBÜ 15-32	15.0 ... 32.0 mm	36.0 x 32.0 x 63.9	10	1716300000

10 x 3 mm busbars	Length	Material	Qty	Order no.
SSch 10x3x1000 Cu, Sn, Pb	1000.0 mm	Cu, Sn, Pb	1	0348900000
SSch 10x3x1000 Fe, Zn, 8B	1000.0 mm	Fe, Zn, 8B	1	1746130000

Marking on the product: 

Marking EN 50019:  EEx e II

Marking EX-RL 94/9/EC: II 2 G D

EC type testing certificate: DMT 02 ATEX E 024 U

For 10 x 3 mm busbars

Clamping yoke

Cable fastened onto the busbar from above

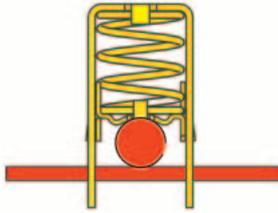

KLBÜ CO 1



KLBÜ CO 2



KLBÜ CO 3



KLBÜ CO 4



KLBÜ CO 5

KLBÜ CO

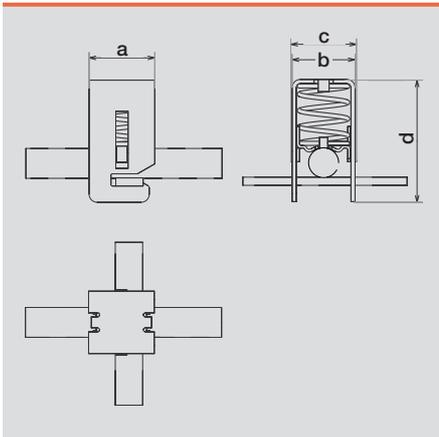

Order data

Type	for cable diameter	Dimensions (a x b x c x d) mm	Qty	Order no.
KLBÜ CO 1	3.0 ... 10.0 mm	18.0 x 12.0 x 13.2 x 32.0	10	1753311001
KLBÜ CO 2	4.0 ... 15.0 mm	18.0 x 20.0 x 21.1 x 41.6	10	1752131001
KLBÜ CO 3	10.0 ... 20.0 mm	25.0 x 23.0 x 24.0 x 45.0	10	1749151001
KLBÜ CO 4	15.0 ... 28.0 mm	25.0 x 31.0 x 32.0 x 56.0	10	1749161001
KLBÜ CO 5	20.0 ... 37.0 mm	32.0 x 40.0 x 42.7 x 64.5	10	1755081001

10 x 3 mm busbars	Length	Material	Qty	Order no.
SSch 10x3x1000 Cu, Sn, Pb	1000.0 mm	Cu, Sn, Pb	1	0348900000
SSch 10x3x1000 Fe, Zn, 8B	1000.0 mm	Fe, Zn, 8B	1	1746130000

Marking on the product: 

Marking EN 50019:  EEx e II

Marking EX-RL 94/9/EC: II 2 G D

EC type testing certificate: DMT 02 ATEX E 024 U

For 10 x 3 mm busbars

Busbar holders

Insulated mounting on TS 35

Type WSH 1

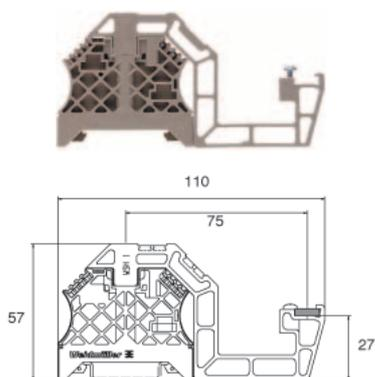

Horizontal mounting only

Type WSH 3/H/N

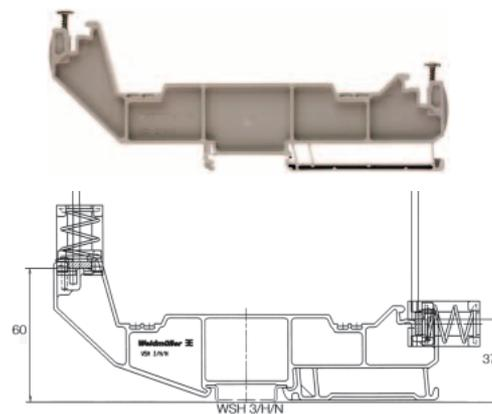

Type WSH 5

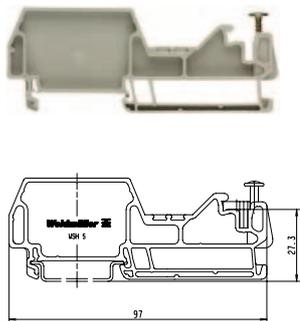

Typ WSH 6

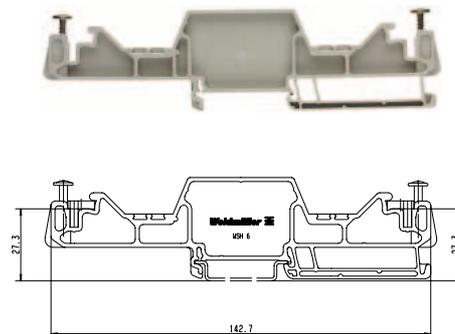

WSH

Order data

Type	Width	Qty	Order no.
WSH 1	8.0 mm	10	1068700000
WSH 3/H/N	8.0 mm	10	1715970000
WSH 5	8.0 mm	10	1080100000
WSH 6	8.0 mm	10	1080200000

EC type testing certificate: DMT 02 ATEX E 024 U

10 x 3 mm busbars	Length	Material	Qty	Order no.
SSch 10x3x1000 Cu, Sn, Pb	1000.0 mm	Cu, Sn, Pb	1	0348900000

For 10 x 3 mm busbars

Busbar holders

Conductive mounting on TS 35



TS 35 Clip
BS 35/WSH 2



Busbar connector
BFEH 1/WSH



Angled rail
SMSE WSH U1MT

Installation example 1

- One busbar
- 2 x WSH 19 MT busbar holder set

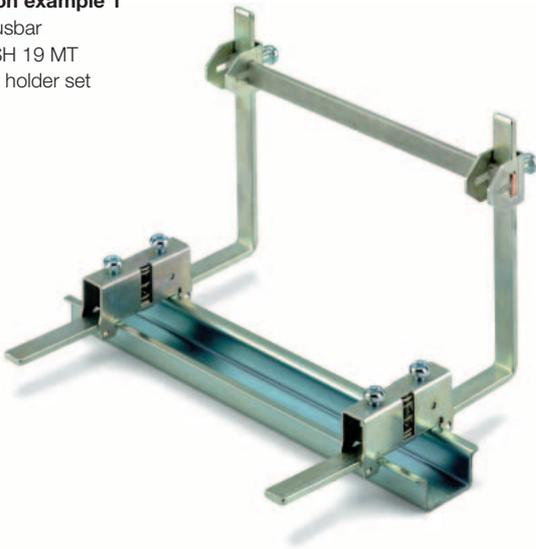

Installation example 2

- Two busbars
- 2 x WSH 18 MT busbar holder set

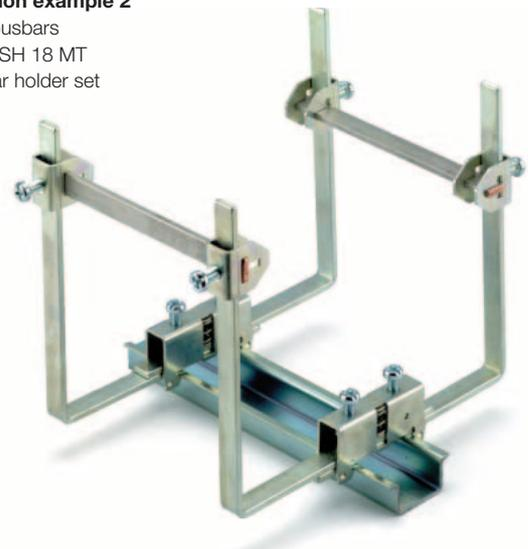

WSH

EC type testing certificate: DMT 02 ATEX E 024 U

Order data

TS 35 clip		Dimensions (l x w x h) mm	Qty	Order no.	
BS 35/WSH 2		52.0 x 37.0 x 13.0	10	1760720000	
Busbar connector		Dimensions (l x w x h) mm	Qty	Order no.	
BFEH 1/WSH		20.0 x 31.0 x 13.5	10	1082400000	
Angle rail		Dimensions (l x w x h) mm	Qty	Order no.	
SMSE WSH U1MT		134.0 x 13.0 x 134.0	10	1083900000	
Busbar holder sets		Contents (parts loose in plastic bag)			
	BS 35/WSH 2	BFEH 1/WSH	SMSE WSH U1MT	Qty	Order no.
WSH 18 MT	1 ea.	2 ea.	2 ea.	10	1083100000
WSH 19 MT	1 ea.	1 ea.	1 ea.	10	1083200000
WSH 20 MT	1 ea.	1 ea.	1 ea. (straight)	10	1752950000
10 x 3 mm busbars		Length	Material	Qty	Order no.
SSch 10x3x1000 Cu, Sn, Pb		1000.0 mm	Cu, Sn, Pb	1	0348900000
SSch 10x3x1000 Fe, Zn, 8B		1000.0 mm	Fe, Zn, 8B	1	1746130000

Mounting directly on metal plate

Clamping yoke



KLBÜ 3 - 8 SC



KLBÜ 4 - 13,5 SC



KLBÜ 10 - 20 SC



KLBÜ 15 - 32 SC

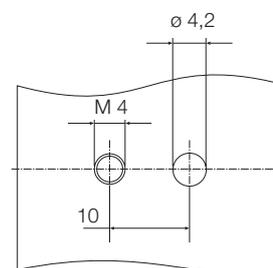

Drilling template KLBÜ 15 - 32 SC

G

KLBÜ SC

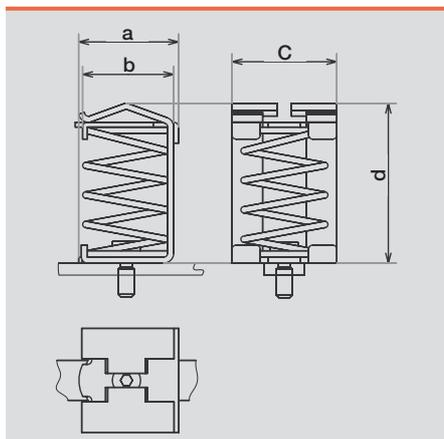

Marking on the product:



Marking EN 50019:

EEx e II

Marking EX-RL 94/9/EC:

II 2 G D

EC type testing certificate: DMT 02 ATEX E 024 U

Order data

Type	For cable diameter	Thread length	Dimensions (a x b x c x d) mm	Qty	Order no.
KLBÜ 3 - 8 SC	3,0 ... 8,0 mm	5,65 mm	13,5 x 11,5 x 18,0 x 26,0	10	1692261001
KLBÜ 4 - 13,5 SC	4,0 ... 13,5 mm	5,30 mm	20,0 x 17,8 x 20,3 x 31,4	10	1712311001
KLBÜ 10 - 20 SC	10,0 ... 20,0 mm	5,30 mm	24,8 x 23,0 x 26,0 x 40,0	10	1712321001
KLBÜ 15 - 32 SC	15,0 ... 32,0 mm	4,80 mm	36,0 x 33,3 x 32,0 x 64,0	10	1718341001

Operating tool

BTWZ KLBÜ

Qty

1

Order no.

1742630000



Mounting directly on metal plate

Busbar holder / Spacer

Busbar holder

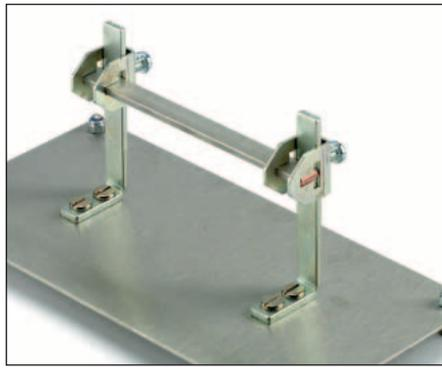

Set (WSH 4 MT) consisting of:
 - 1 busbar holder
 - 1 busbar connector (BFEH 1/WSH)

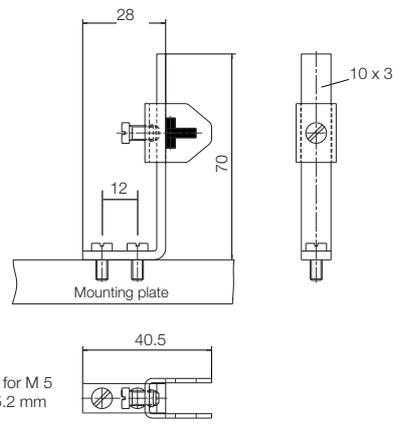

Spacer

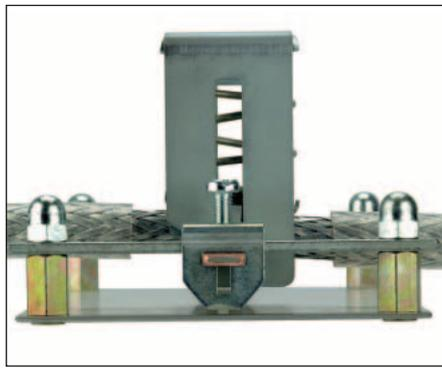

M6 outer and inner thread
 (15 mm, 20 mm and 30 mm long)



WSH 4 MT / SP

Order data

Busbar holder	Qty	Order no.
WSH 4 MT	10	1079900000

Type	Length	Qty	Order no.
SP 15 set of 2	15 mm	1	3896100000
SP 20 set of 2	20 mm	1	3896200000
SP 30 set of 2	30 mm	1	3896300000

EC type testing certificate: DMT 02 ATEX E 024 U



Mounting on TS 35

FM 4-foot / Clamping yoke holder

FM 4-foot



The KLBÜ SC clamping yokes (see page F.8) are screwed onto the **FM 4** foot.



Clamping yoke holder

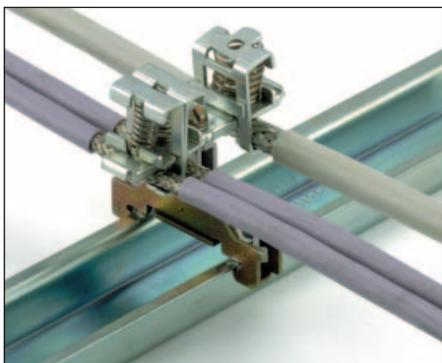

BS 35 II (without KLBÜ)



BS 35 II / KLBÜ 3 - 8

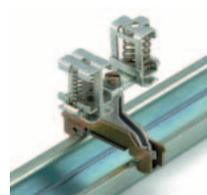

BS 35 II / KLBÜ 3-8 / 2x2-6

FM 4 / BS 35 II

Order data

FM 4-foot	Qty	Order no.
FM 4	40	0687900000

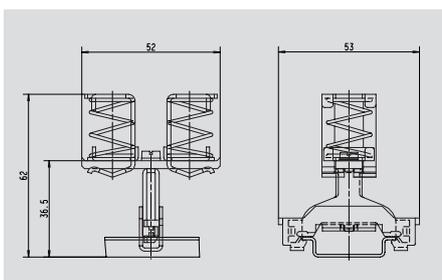

Clamping yoke	For cable diameter	Qty	Order no.
BS 35 II	without KLBÜ	10	1723800000
BS 35 II / KLBÜ 3-8	3.0 ... 8.0 mm	10	1723810000
BS 35 II / KLBÜ 4-13.5	4.0 ... 13.5 mm	10	1723820000
BS 35 II / KLBÜ 3-8/2x2-6	3.0 ... 8.0 mm / 2.0 ... 6.0 mm	10	1749430000
BS 35 II / KLBÜ 2x3-8/2x2-6	3.0 ... 8.0 mm / 2.0 ... 6.0 mm	10	1768020000

Marking on the product: 

Marking EN 50019:  EEx e II

Marking EX-RL 94/9/EC: II 2 G D

EC type testing certificate: DMT 02 ATEX E 024 U

For C-profiles

Clamping yoke



KLBÜ 3 - 8 CPF



KLBÜ 4 - 13.5 CPF



KLBÜ 10 - 20 CPF



KLBÜ 15 - 32 CPF

KLBÜ CPF

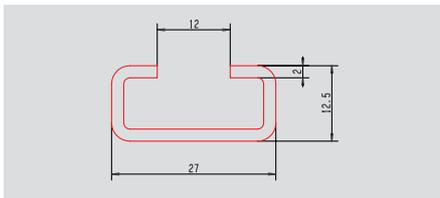
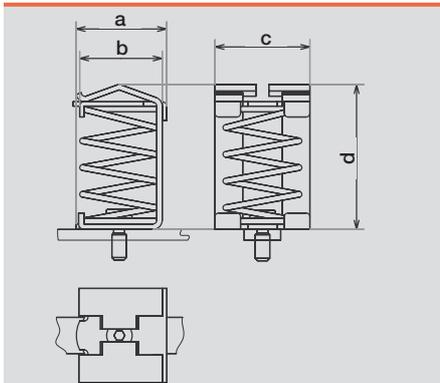

Order data

Type	For cable diameter	Dimensions (a x b x c x d) mm	Qty	Order no.
KLBÜ 3 - 8 CPF	3.0 ... 8.0 mm	13.5 x 11.5 x 18.0 x 26.0	10	1752681001
KLBÜ 4 - 13.5 CPF	4.0 ... 13.5 mm	20.0 x 17.8 x 20.3 x 31.4	10	1752691001
KLBÜ 10 - 20 CPF	10.0 ... 20.0 mm	24.8 x 23.0 x 26.0 x 40.0	10	1752701001
KLBÜ 15 - 32 CPF	15.0 ... 32.0 mm	36.0 x 33.3 x 32.0 x 64.0	10	1752711001

C-rail	Qty	Order no.
TS 27 x 12.5M / ST / FZN	10 m	1802690000

Marking on the product: 

Marking EN 50019:  EEx e II

Marking EX-RL 94/9/EC: II 2 G D

EC type testing certificate: DMT 02 ATEX E 024 U

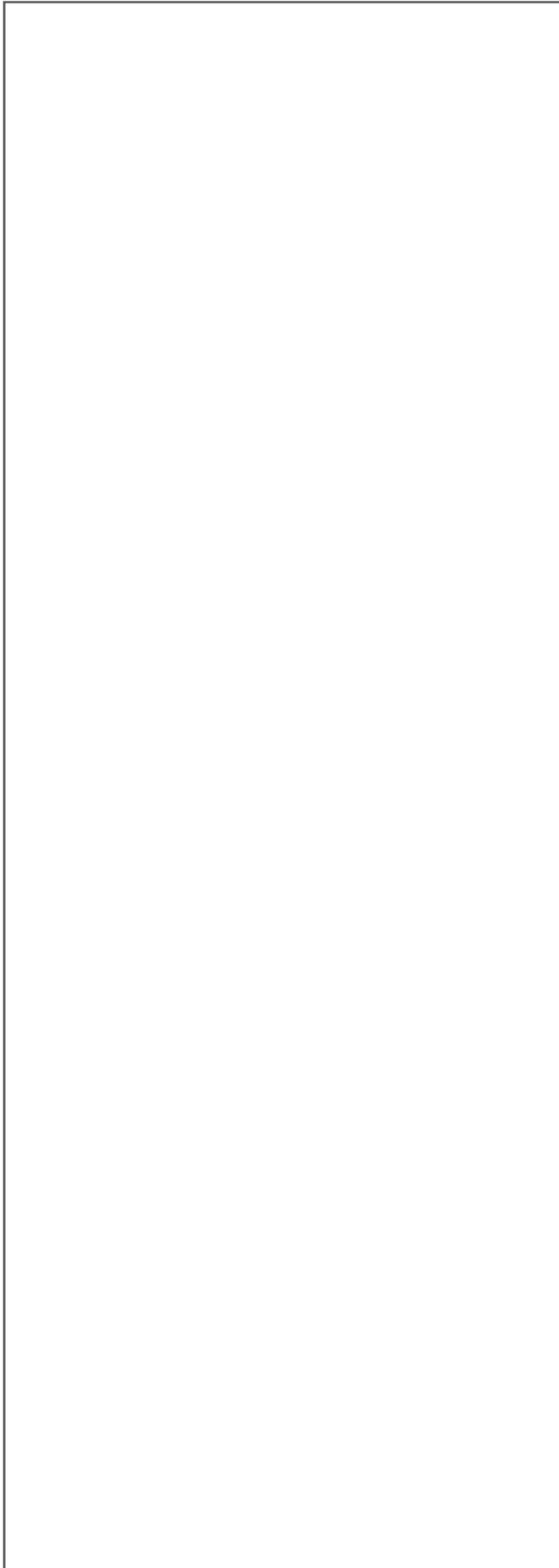

Busbar systems		
Busbars, Busbar holders	H.2	- H.3
Tension clip, uninsulated / insulated	H.4	- H.5
Mounting rail system		
Overview	H.6	- H.7
Mounting rails TS15, TS 32, TS 35	H.8	- H.9
End holders	H.10	
Mounting rail supports, Mounting feet	H.11	

Busbar systems

Busbars

In switchgears and controls, it may be necessary to bring the neutral conductor and the protective conductor together at a central point. Busbars are available for this purpose and can be used for connecting a large number of conductors in a confined space (up to 70 conductors on a 1 m busbar). The conductors are connected by means of a pressure piece or tension clamp; the former does not entail bending the eyelets. A guide lug on the pressure piece engages in the busbar and holds the pressure piece firmly so that it cannot twist. The tension clamps can be pushed on the busbar and adjusted to the entire wiring in the system. The busbars can be used unperforated in any lengths. They are fixed using the SH busbar holder which can, for longer busbars, also be positioned between the tension clamps.

Tension clamps

(see page F.24 – F.25)

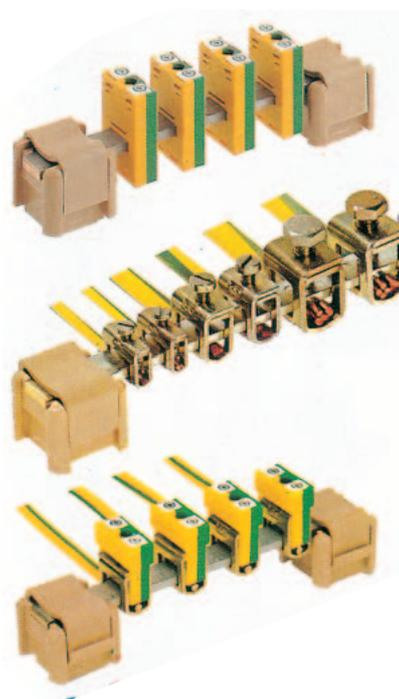

In order to bring together neutral conductors and protective conductors at a central point, it is advantageous to use ZB tension clamps together with 10 x 3 or 6 x 6 busbars. The tension clamps can be pushed onto the busbar and adjusted to the entire wiring in the system.

The tension clamp serves as the protective conductor connection and can be supplied with green/yellow insulating caps. These caps indicate the protective function and marking tags allow clear identification of each conductor.

If the tension clamps are used to connect neutral conductors, they can be marked with a blue insulating cap.

ZBE6 can also be swivelled onto the busbar retrospectively.

Busbars, unperforated



SSch

Type	Material	Cross-section	Length	Current carrying capacity	Qty	Order no.
SSch 10x3	Copper, tin-plated	10 x 3 mm	1 m	140 A	1	0348900000
SSch 10x3	Steel, galvanised	10 x 3 mm	1 m		1	0438000000
SSch 10x3	Brass, bright	10 x 3 mm	1 m	100 A	1	0259800000
SSch 6x6	Copper, tin-plated	6 x 6 mm	1 m	140 A	1	0571300000
SSch 6x6	Brass, bright	6 x 6 mm	1 m	100 A	1	0571200000
SSch 15x6	Copper, tin-plated	15 x 6 mm	1 m	265 A	1	0357400000

Busbars, perforated

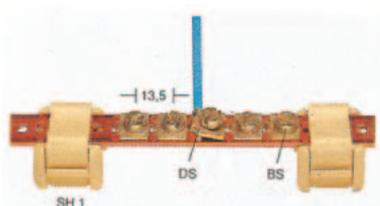

NSch / ESch

Type	Material	Cross-section	Length	Power Rating	Qty	Order no.
NSch 15x2	Copper, bright	15 x 2 mm	1 m	80 A	1	0280200000
ESch 12x2	Steel, galvanised	12 x 2 mm	1 m		1	0280300000

Pressure piece	Qty	Order no.
DKSUE	100	0280100000
Clamping screw	Qty	Order no.
BFSC M5x8	100	0296700000

Connection data NSch/ESch

Screw connection solid	0.5 ... 2.5 mm ²
Stripping length	9 mm
Cable lug connection	max. 16 mm ²
Max. current per connection	27 A

Busbar systems

Busbar holders

With clip and base

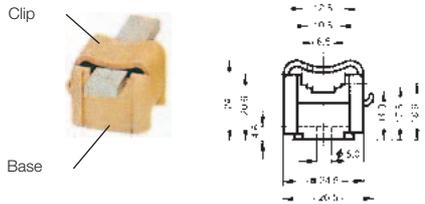

SH

Type	For busbar cross-section	Qty.	Order no.
SH 1 TS 15 complete	10x3, 6x6, 15x2, 12x2	20	0299860000

Individual parts SH1

SH 1 base		20	0401460000
SH 1 clip		500	0635960000

Fixing screw for SH1

BFSC M4x9	for 1 SH1	100	0103300000
BFSC M4x30	for 2 SH1 stacked	50	0267100000

With metal bridge

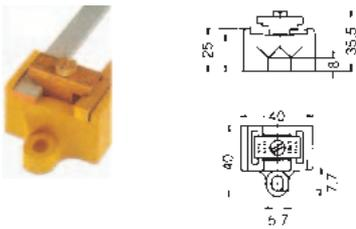

Type	For busbar cross-section	Qty.	Order no.
SH 2S	10x3, 6x6, 15x6, 10x5	10	0641720000

With metal bridge

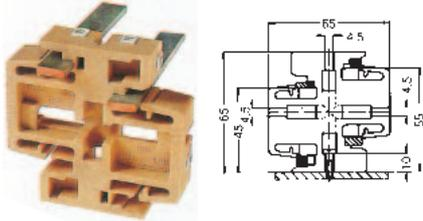

Type	For busbar cross-section	Qty.	Order no.
SH 3	10x3, 6x6, 10x5	10	0556660000

Busbar holders

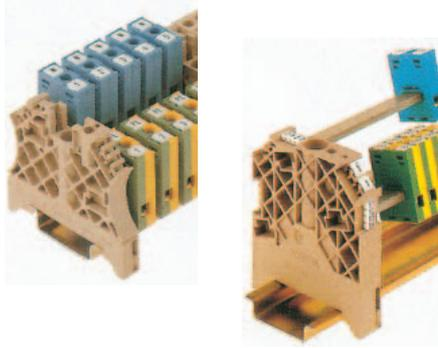

WEW

Type	For busbar cross-section	Qty.	Order no.
WEW 35/1	10x3, 6x6	50	1059000000
WEW 35/2	10x3, 6x6	100	1061200000

WEW 35/1 and WEW35/2 as busbar holder together with the ZB 4 G tension clamp

Connection element

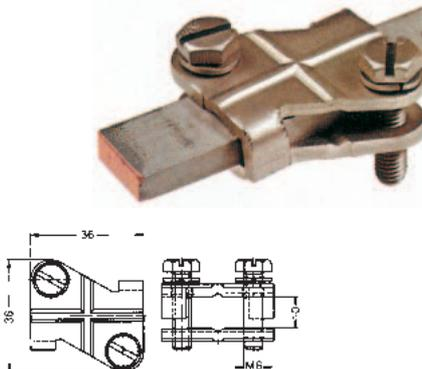

AK 95

Type	For busbar cross-section	Qty.	Order no.
AK 95	15 x 6 mm	10	0364200000

The AK95 connection element is used as a tension clamp for 15 x 6 busbars
 Connection cross-sections
 $e = 6 \dots 16 \text{ mm}^2$
 $f = 6 \dots 50 \text{ mm}^2$
 $m = 16 \dots 50 \text{ mm}^2$

Busbar systems

Clamping yoke, insulated

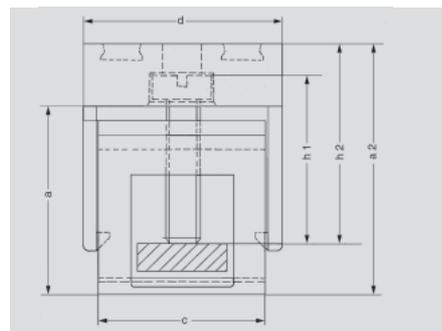

For 10 x 3 mm busbars



Connection cross-section:
 Solid 0.5 ... 6.0 mm²
 Flexible 0.5 ... 4.0 mm²
 Stranded -
 Clamping screw M 3
 Stripping length 16 mm

For swivelling on retrospectively



Connection cross-section:
 Solid 1.0 ... 10 mm²
 Flexible 1.5 ... 10 mm²
 Stranded -
 Clamping screw M 4
 Stripping length 19 mm

Also for busbar 10 x 5 mm available



Connection cross-section:
 Solid 1.5 ... 10 mm²
 Flexible 2.5 ... 10 mm²
 Stranded -
 Clamping screw M 4
 Stripping length 19 mm



Connection cross-section:
 Solid 2.5 ... 16 mm²
 Flexible 2.5 ... 16 mm²
 Stranded 16 ... 25 mm²
 Clamping screw M 4
 Stripping length 16 mm



Connection cross-section:
 Solid -
 Flexible 16 ... 35 mm²
 Stranded 16 ... 50 mm²
 Clamping screw M 6
 Stripping length 19 mm

For 6 x 6 mm busbars



Connection cross-section:
 Solid 0.5 ... 6.0 mm²
 flexible 0.5 ... 4.0 mm²
 Stranded -
 Clamping screw M 3
 Stripping length 16 mm



Connection cross-section:
 Solid 2.5 ... 16 mm²
 Flexible 2.5 ... 16 mm²
 Stranded 16 ... 25 mm²
 Clamping screw M 4
 Stripping length 12 mm

ZB / ZBE

Type	Colour	Dimensions [mm]			Qty	Order no.
		a	width	c		
ZB 4, bright	-	11.7	5.6	16.0	50	0316500000
Insulating cap	Blue				50	0475480000
Insulating cap	Green/yellow				50	0475460000
ZBE 6, bright	-	19.5	8.2	19.5	50	0459500000
Insulating cap	Blue				50	0526080000
Insulating cap	Green/yellow				50	0526060000
ZB 10, bright	-	19.5	8.2	19.5	50	1261300000
ZB 16, bright	-	17.0	10.0	16.0	50	0316600000
Insulating cap	Blue				50	0502980000
Insulating cap	Green/yellow				50	0502960000
ZB 35, bright	-	21.0	14.4	18.4	20	0266500000
Insulating cap	Blue				50	0502780000
Insulating cap	Green/yellow				50	0502760000

ZB

Type	Colour	Dimensions [mm]			Qty	Order no.
		a	width	c		
ZB 4/6, bright	-	14.7	5.6	12.5	50	0556700000
Insulating cap	Blue				50	0565380000
ZB 16/6, bright	-	19.0	10.0	12.5	50	0556800000
Insulating cap	Blue				50	0565580000
Insulating cap	Green/yellow				50	0565560000

Busbar systems

Clamping yoke, insulated

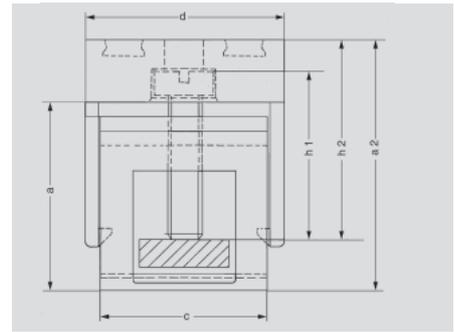

For busbars 10 x 3 mm



Connection cross-section:
 Solid 0.5 ... 6.0 mm²
 Flexible 0.5 ... 4.0 mm²
 Stranded -
 Clamping screw M 3
 Stripping length 16 mm

For swivelling on retrospectively



Connection cross-section:
 Solid 1.0 ... 10 mm²
 Flexible 1.5 ... 10 mm²
 Stranded -
 Clamping screw M 4
 Stripping length 19 mm



Connection cross-section:
 Solid 2.5 ... 16 mm²
 Flexible 2.5 ... 16 mm²
 Stranded 16 ... 25 mm²
 Clamping screw M 4
 Stripping length 16 mm

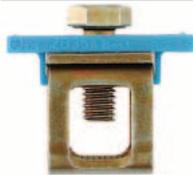

Connection cross-section:
 Solid -
 Flexible 16 ... 35 mm²
 Stranded 16 ... 50 mm²
 Clamping screw M 6
 Stripping length 19 mm

Tension spring connection



Connection cross-section:
 Solid 0.5 ... 4.0 mm²
 Flexible 0.5 ... 2.5 mm²
 Stranded -
 Stripping length 10 mm

ZB / ZBE / ZF

Type	Colour	Dimensions [mm]				Qty	Order no.
		a2	width	d	h2		
ZB 4 G GN/GE	Green/yellow	27.0	7.6	19.7	15.5	50	0322160000
ZB 4 G BL	Blue	27.0	7.6	19.7	15.5	50	0322180000
ZB 4 G SW	Black	27.0	7.6	19.7	15.5	50	0322110000
ZB 4K GN/GE	Green/yellow	18.5	6.0	19.0	13.0	50	0475360000
ZB 4K BL	Blue	18.5	6.0	19.0	13.0	50	0475380000
ZBE 6K GN/GE	Green/yellow	27.0	8.0	22.5	23.0	50	0525960000
ZBE 6K BL	Blue	27.0	8.0	22.5	23.0	50	0525980000
ZBE 6K SW	Black	27.0	8.0	22.5	23.0	50	0525910000
ZB 16K GN/GE	Green/yellow	24.0	10.0	19.2	20.0	50	0502860000
ZB 16K BL	Blue	24.0	10.0	19.2	20.0	50	0502880000
ZB 16K SW	Black	24.0	10.0	19.2	20.0	50	0502810000
ZB 35K GN/GE	Green/yellow	25.0	14.4	32.0	20.5	20	0502660000
ZB 35K BL	Blue	25.0	14.4	32.0	20.5	20	0502680000
ZB 35K SW	Black	25.0	14.4	32.0	20.5	20	0502610000
ZF 4 S	Beige	22.0	6.1	24.5	-	50	1814680000
ZF 4 S BL	Blue	22.0	6.1	24.5	-	50	1814660000
ZF 4 S GN/GE	Green/yellow	22.0	6.1	24.5	-	50	1814670000

For 6 x 6 mm busbar



Connection cross-section:
 Solid 0.5 ... 6.0 mm²
 Flexible 0.5 ... 4.0 mm²
 Stranded -
 Clamping screw M 3
 Stripping length 16 mm



Connection cross-section:
 Solid 2.5 ... 16 mm²
 Flexible 2.5 ... 16 mm²
 Stranded 16 ... 25 mm²
 Clamping screw M 4
 Stripping length 12 mm

ZB

Type	Colour	Dimensions [mm]				Qty	Order no.
		a2	width	d	h2		
ZB 4/6K GN/GE	Green/yellow	21.2	6.0	25.0	14.0	50	0565460000
ZB 4/6K BL	Blue	21.2	6.0	25.0	14.0	50	0565480000
ZB 16/6K GN/GE	Green/yellow	26.0	9.7	25.0	20.0	50	0569660000
ZB 16/6K BL	Blue	26.0	9.7	25.0	20.0	50	0569680000

Mounting rails, profile rails, end holders

Both active and passive components and intelligent modules are mounted on mounting rails – a method which has proven its worth over the years. But it is only after the use of certain consumables – which are frequently not taken into consideration – that electrical installation is finally completed. In this chapter, users will find a range of mounting rails and profile rails for component installation together with end holders for holding and isolating the components. This guarantees firm installation and isolation. Weidmüller supplies components which show perfect functional compatibility.

Mounting rails are made of either steel, stainless steel, aluminium or copper, depending on the area of application.

Stainless steel

Stainless steel is a collective noun for all kinds of steel (alloys) which are smelted in a special process and have a high degree of purity. Stainless steel has much-enhanced resistance to corrosion. Weidmüller's stainless steel mounting rails have the following composition: X5 CrNi 18-10 stainless steel (i.e. ~ 18% chromium, ~ 10% nickel).

Aluminium

Aluminium is second only to copper in its electrical conductivity. One advantage is its light weight. Aluminium oxidises quickly in air; thus passivated, it offers excellent corrosion protection.

Copper

Copper, a heavy metal, has the best electrical conductivity of all metals used. As it is a soft metal, Weidmüller's mounting rails are 2.3 mm thick.

Steel

All steel versions are galvanised and also passivated with a chromate layer, differentiated into yellow (chromium VI) and blue chromate (chromium III). Blue chromating has been introduced because of future restrictions on chromium (VI) compounds.

All mounting rails are produced in 1 m and 2 m lengths.

A mounting rail can also be used as a protective conductor busbar. Weidmüller PE / earth terminals in the W series, Z series, I series, SAK and AKZ series comply with requirements stipulated in IEC 60 947-7-2. According to VDE 0100 part 540, for conductors with cross-sectional areas exceeding 10 mm², both protective and neutral conductors may be grouped together as a single category of conductors designated PEN.

If a mounting rail is used as a PEN busbar, the following criteria must be observed:

- Only E-Cu or aluminium profiles are allowed
- Short-circuit currents and thermal rated currents must be taken into account
- The mounting rails are to be insulated as a contribution to protective insulation

All unperforated mounting rails can be provided with fixing holes (state dimensions b and l2).

Possible diameters are 3.5 / 5.6 / 5.5 / 7 mm.

All unperforated steel rails can also be supplied with welded on steel studs (state dimension a and required studs).

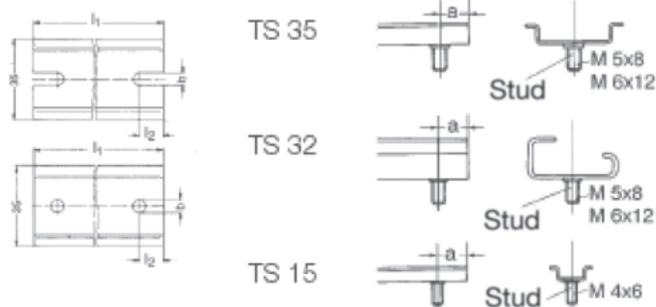

Mounting rails

TS 15 

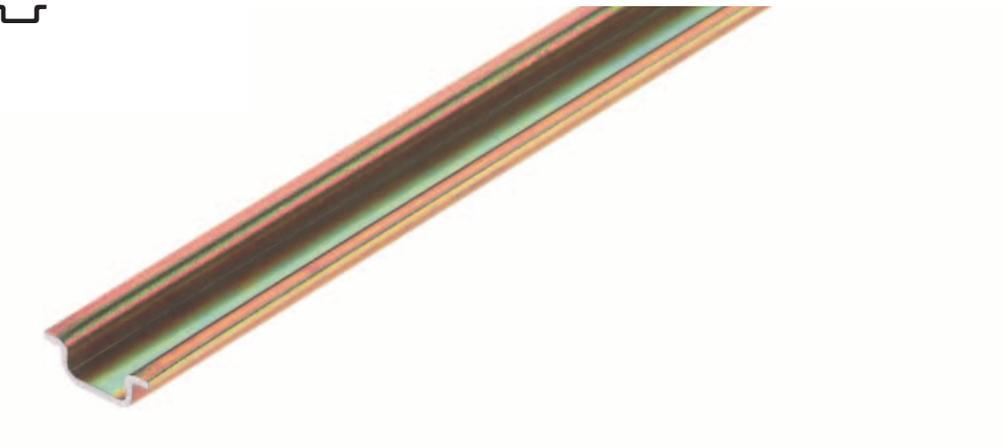

TS 32 

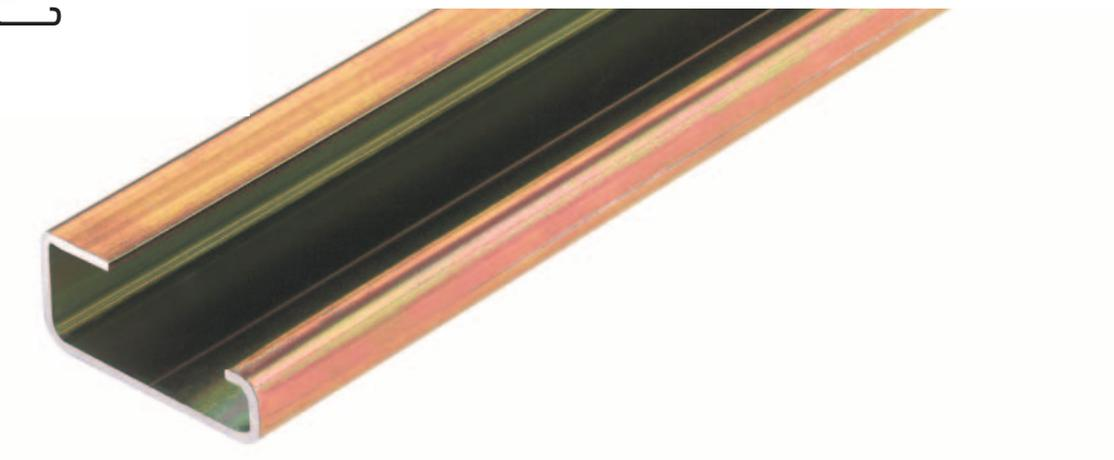

TS 35 

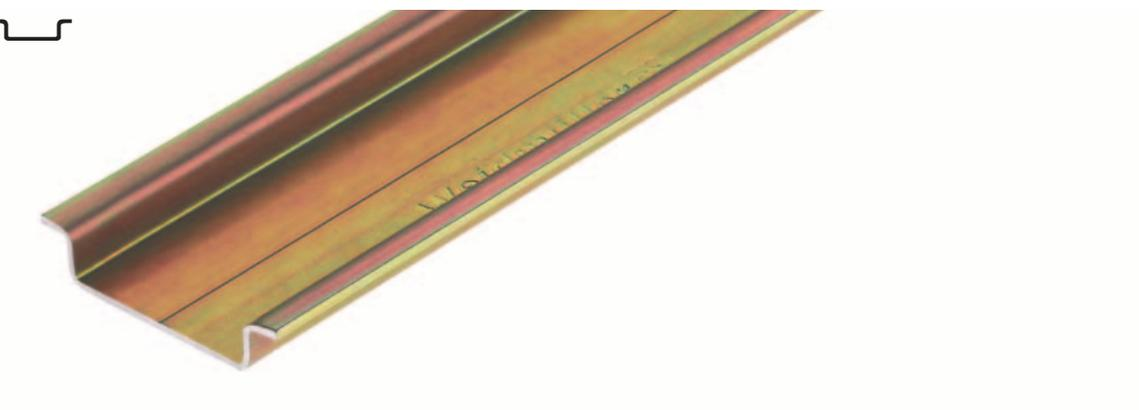

Mounting rail systems

TS15 mounting rail

Unperforated

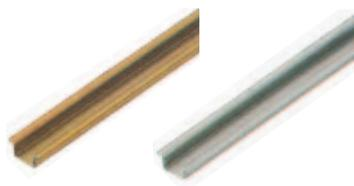

TS 15 x 5

Aluminium, bright	Short-circuit strength	Material thickness	Length	Qty	Order no.
TS 15x5 2M/AL/BK (max. tolerable rated current for PEN function = 76 A)	16 mm ²	1 mm	2 m	10 m	0134700000
Steel, galvanised / yellow passivated					
TS 15x5 2M/ST/ZN	10 mm ²	1 mm	2 m	2 m	0514200000
TS 15x5 1M/ST/ZN	10 mm ²	1 mm	1 m	10 m	0514210000

With slotted hole

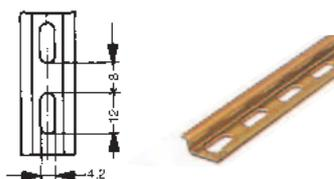

Aluminium, bright	Short-circuit strength	Material thickness	Length	Qty	Order no.
TS 15x5/LL 2M/AL/BK (max. tolerable rated current for PEN function = 76 A)	16 mm ²	1 mm	2 m	2 m	0217900000
Steel, galvanised / yellow passivated					
TS 15x5/LL 2M/ST/ZN	10 mm ²	1 mm	2 m	2 m	0117500000
TS 15x5/LL 1M/ST/ZN	10 mm ²	1 mm	1 m	10 m	0117510000

TS 32 mounting rail

Unperforated

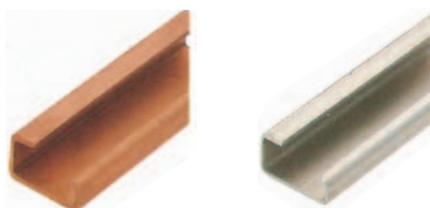

TS 32 x 15

Aluminium, bright	Short-circuit strength	Material thickness	Length	Qty	Order no.
TS 32X15 2M/AL/BK (max. tolerable rated current for PEN function = 192 A)	70 mm ²	1,5 mm	2 m	2 m	0169300000
Steel, galvanised / yellow passivated					
TS 32X15 2M/ST/ZN	35 mm ²	1,5 mm	2 m	2 m	0122800000
TS 32X15 1M/ST/ZN	35 mm ²	1,5 mm	1 m	10 m	0122810000

Copper, bright

TS 32X16.2 2M/CU/BK (max. tolerable rated current for PEN function = 269 A)	120 mm ²	2,1 mm	2 m	2 m	0364300000
--	---------------------	--------	-----	-----	------------

Stainless steel, bright

TS 32X15 2M/CRN	35 mm ²	1,5 mm	2 m	2 m	0293220000
-----------------	--------------------	--------	-----	-----	------------

With slotted hole

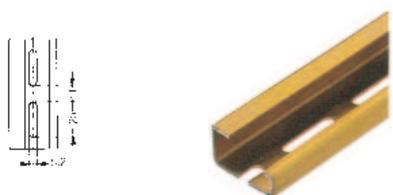

Steel, galvanised / yellow passivated	Short-circuit strength	Material thickness	Length	Qty	Order no.
TS 32X15/LL 2M/ST/ZN	35 mm ²	1,5 mm	2 m	2 m	0514400000
TS 32X15/LL 1M/ST/ZN	35 mm ²	1,5 mm	1 m	10 m	0514410000

Mounting rail systems

TS 35 mounting rail

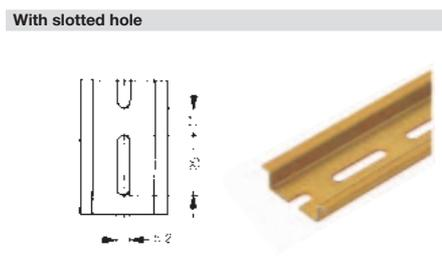

TS 35 x 7,5

Material	Short-circuit strength	Material thickness	Length	Qty	Order no.
Aluminium, bright					
TS 35X7.5 2M/AL/BK	35 mm ²	1 mm	2 m	2 m	0330800000
(max. tolerable rated current for PEN function = 125 A)					
Steel, galvanised / yellow passivated					
TS 35X7.5 2M/ST/ZN	16 mm ²	1 mm	2 m	2 m	0383400000
TS 35X7.5 1M/ST/ZN	16 mm ²	1 mm	1 m	10 m	0383410000
Stainless steel, bright					
TS 35X7.5 2M/CRN	16 mm ²	1 mm	2 m	2 m	1747350000
Steel, galvanised / yellow passivated					
TS 35X7.5/LL 2M/ST/ZN	16 mm ²	1 mm	2 m	2 m	0514500000
TS 35X7.5/LL 1M/ST/ZN	16 mm ²	1 mm	1 m	10 m	0514510000
Steel, galvanised / blue passivated					
TS 35X7.5/LL 2M/ST/ZN /WS/BL	16 mm ²	1 mm	2 m	2 m	0514580000

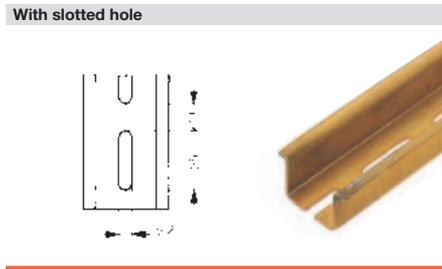
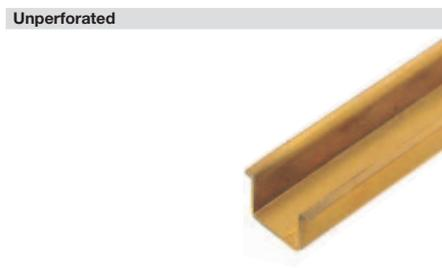

TS 35 x 15

Material	Short-circuit strength	Material thickness	Length	Qty	Order no.
Copper, bright					
TS 35X15/2.3 2M/CU/BK	150 mm ²	2.3 mm	2 m	2 m	0270100000
(max. tolerable rated current for PEN function = 309 A)					
Steel, galvanised / yellow passivated					
TS 35X15/2.3 2M/ST/ZN	50 mm ²	2.3 mm	2 m	2 m	0498000000
Aluminium, bright					
TS 35X15/2.3 2M/AL/BK	70 mm ²	2.3 mm	2 m	2 m	1848290000
(max. tolerable rated current for PEN function = 192 A)					
Steel, galvanised / yellow passivated					
TS 35X15 2M/ST/ZN	25 mm ²	1.5 mm	2 m	2 m	0236400000
TS 35X15 1M/ST/ZN	25 mm ²	1.5 mm	1 m	10 m	0236410000
Steel, galvanised / yellow passivated					
TS 35X15/LL 2M/ST/ZN	25 mm ²	1.5 mm	2 m	2 m	0236500000
TS 35X15/LL 1M/ST/ZN	25 mm ²	1.5 mm	1 m	10 m	0236510000



TSK 35 x 15

Material	Length	Qty	Order no.
PVC RAL 7035			
TSK 35X15 2M PVC/GR	2 m	2 m	0514300000

Mounting rail systems

End holders

For TS 15 mounting rail

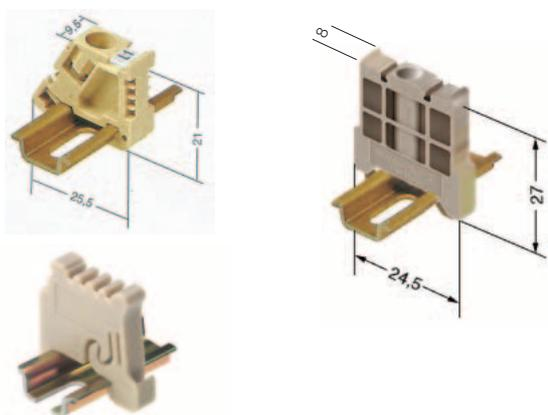

Polyamide 66, screwable	Colour	Torque	Qty	Order no.
EWK AKA 2.5	Beige	0.4 Nm	50	0348660000
EW 15	Beige	0.4 Nm	50	0382860000

Polyamide with fibreglass, screwable	Colour	Torque	Qty	Order no.
EW 15/2	Dark beige	0.4 Nm	50	1071900000

Polyamide 66, screwless	Colour	Torque	Qty	Order no.
ZEW 15	Beige	-	20	7920340000

For mounting rail TS 32

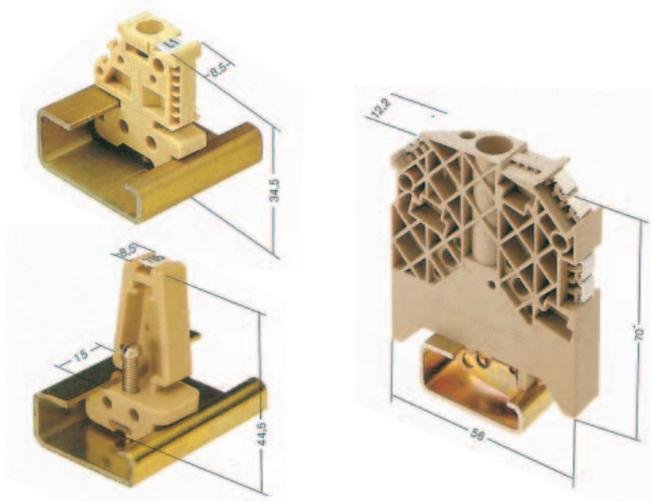

Polyamide 66, screwable	Colour	Torque	Qty	Order no.
EWK 2	Beige	1.2 Nm	50	0199360000
EWK 1 TS 32 M4X18	Beige	1.2 Nm	50	0206160000
EWK 1 ALT	Beige	0.6 Nm	50	0495160000

Polyamide with fibreglass, screwable	Colour	Torque	Qty	Order no.
WEW 32/1	Dark beige	0.9 Nm	50	1067600000

For mounting rail TS 35

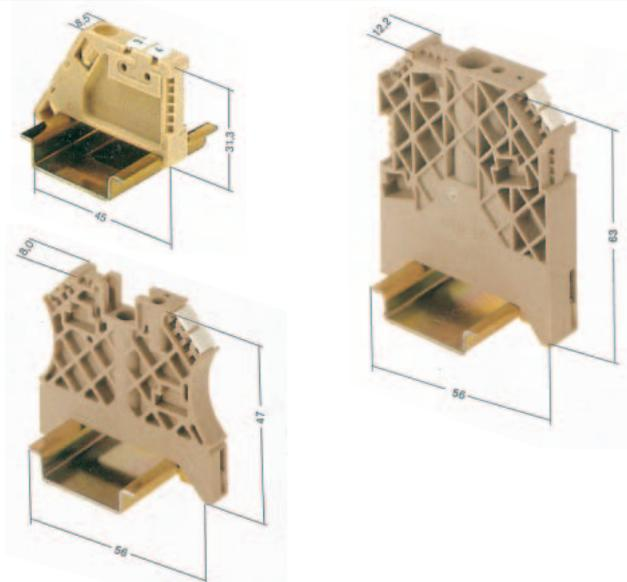

Polyamide 66, screwable	Colour	Torque	Qty	Order no.
EW 35 GR	Grey	0.5 Nm	50	0383530000
EW 35	Beige	0.5 Nm	50	0383560000

Polyamide with fibreglass, screwable	Colour	Torque	Qty	Order no.
WEW 35/1	Dark beige	1.2 Nm	50	1059000000
WEW-35/2	Dark beige	0.5 Nm	100	1061200000

Polyamide 66, screwless	Colour	Torque	Qty	Order no.
ZEW	Beige	-	20	9540000000
ZEW 35/2	Beige	-	20	8630740000

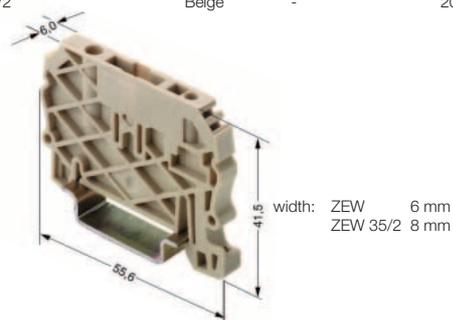

Mounting rail systems

Mounting rail supports / Mounting feet

Mounting rail supports

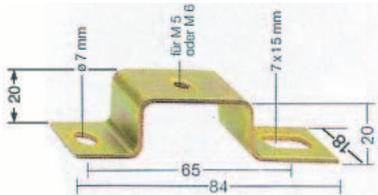
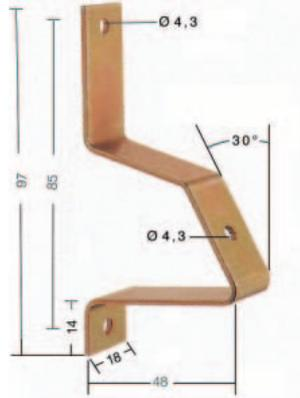
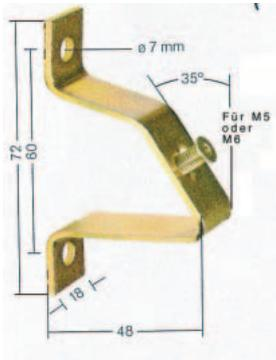

	Thread	Qty	Order no.
TSTW 5/M5	M5	10	0178100000
TSTW 5/M5 verzinkt	M5	10	1779100000
TSTW 6/M6	M6	10	0164000000
TSTW D 4.3	Hole \varnothing 4,3 mm	10	1610110000

Mounting rail supports of type **TSTW** are used for angled fixing of mounting rails at an angle of 35°.

TST 2/M5	M5	10	1286600000
TST 2/M6	M6	10	0101700000

The **TST** mounting rail support is used for assembly of mounting rails in a frame or over a cut-out

Fixing screws

FKSC M5x8 \varnothing 9	50	0295900000
FKSC M6x8 \varnothing 9	50	0642600000
FKSC M6x12 \varnothing 9	50	0353500000

Weidmüller supplies fixing screws with hexagonal sockets and a very low head for the mounting rail supports so that the terminals can also be fitted over the screw.

Mounting feet

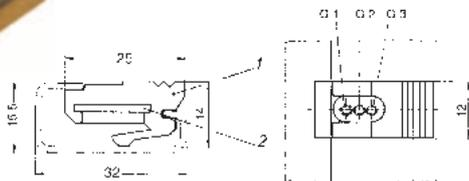
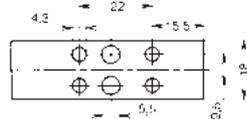
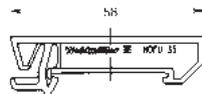
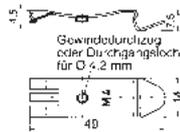
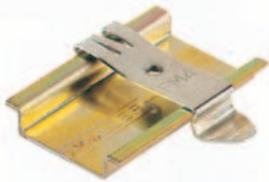

Clip-on foot, steel for TS 35	Thread	Qty	Order no.
FM 4	M4	40	0687900000
FM 5	M5	40	0636800000
FM 6	M6	40	0636900000
FM 4.2	Hole \varnothing 4,2 mm	40	1724580000

Assembly foot, PA orange for TS 35

MOFU 35/LO/1	With holes	20	0646260000
MOFU 35		20	0495660000

Sliding nut for TS 34

		Colour	
MB M3/M5	M3 and M5	Cream	20 0503500000
MB M5/M3	M5 and M3	Black	20 0553400000
MB M6/M4	M6 and M4	Grey	20 0334900000

The sliding nut for the RS 32 mounting rail has two threaded holes for screws M3 + M5 / M6 + M4 / M5 + M3. It is used to fasten components which cannot be slotted directly onto the TS 32, in particular the smaller TS 15 top hat rail.

This enables, for example, mini-terminals to be snapped onto the TS 15 first, and this rail is then fastened together with the terminals to the TS 32 using the sliding nut.

Accessories

Overview	I.2	- I.3
Visual separation – side covers	I.4	- I.5
Colour coding options	I.6	- I.7
Potential distribution	I.8	- I.13
Testing/Checking	I.14	- I.15
Protective covers	I.16	- I.18
Accessories for modular disconnect test terminals	I.20	- I.21

Overview

The extra functions

Weidmüller can supply an extensive range of accessories for users of the SAK series of modular terminals. These help to provide the right solution for all manner of tasks, even those outside the scope of standard functions.

And of course, the accessories have to satisfy the same high standards of quality as the modular terminals themselves.

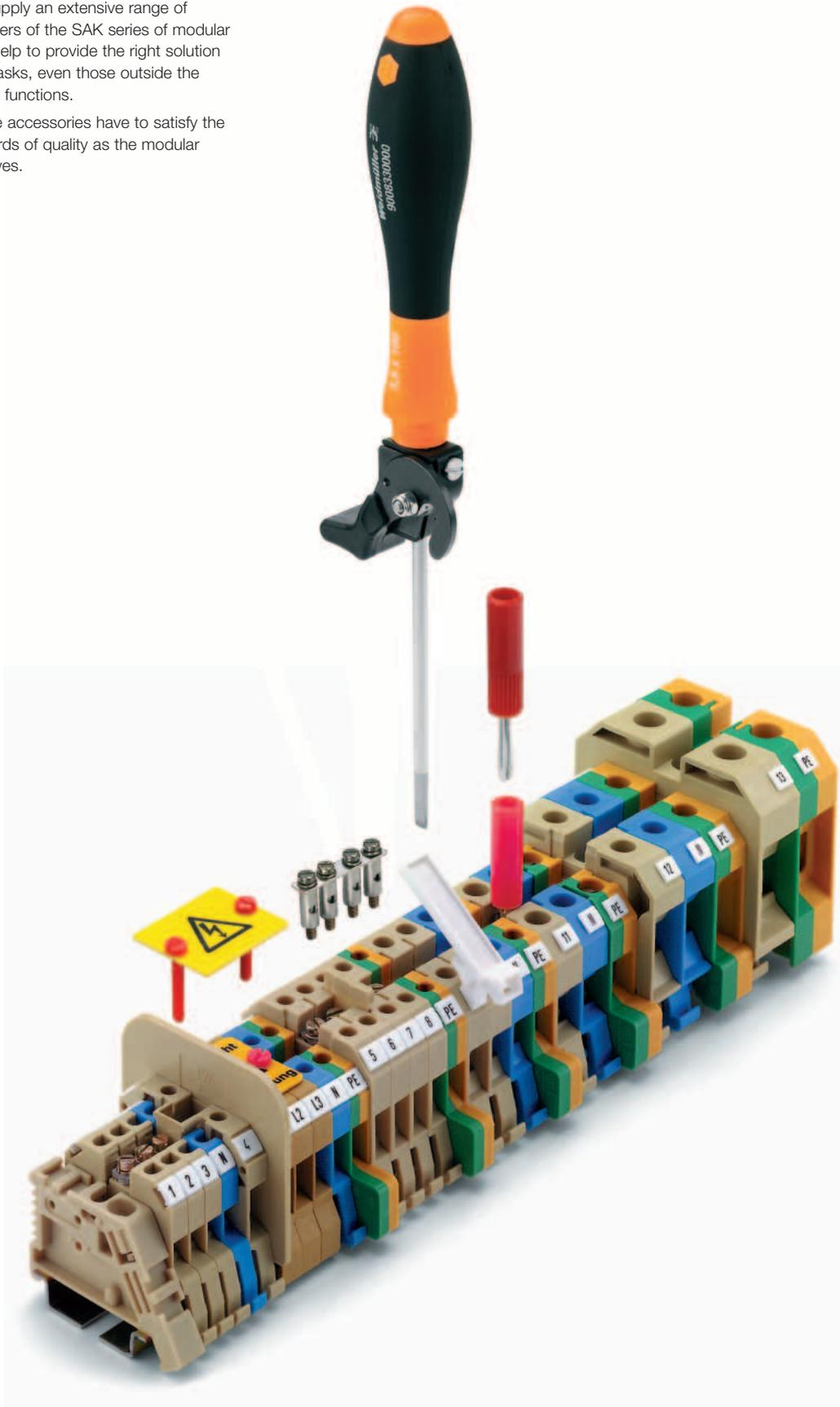

Overview

Visual separation – side covers

page 1.4



To guarantee protection against fingers coming into contact with live parts when working with modular terminals, open sides are blocked off with end cover plates and partition plates.

But in addition, end cover plates and partition plates are available in various colours and so can be used to create a visual distinction between different circuits.

Colour coding options

page 1.6



Another helpful feature of the accessories for modular terminals with screw connections are the different colours available.

Potential distribution

page 1.8

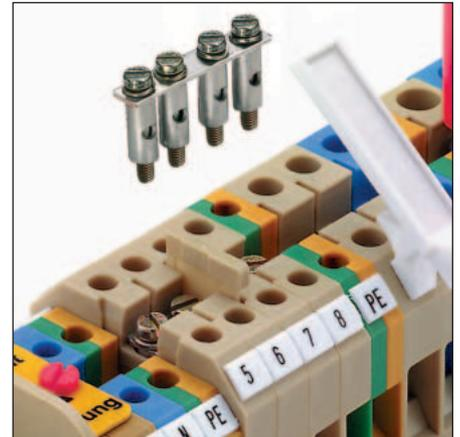

Some 60% of all modular terminals are cross-connected. Weidmüller can supply a wide range of solutions.

Testing / Checking

page 1.14

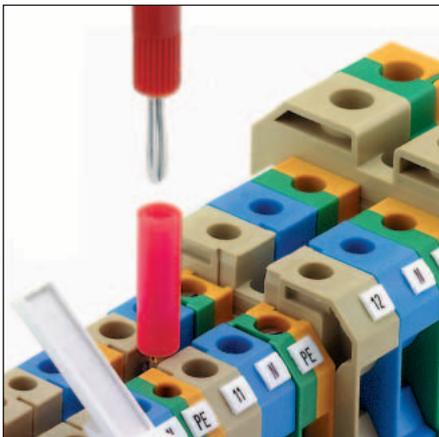

Weidmüller test plugs and sockets guarantee that the necessary tests can be carried out on the installation.

Protective covers

page 1.16

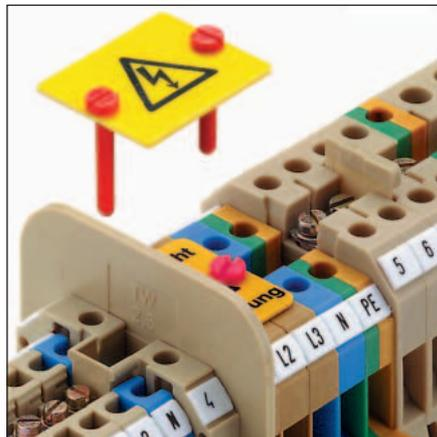

Electrical installations must be safe at all times. Therefore, Weidmüller can supply a large range of protective cover strips and plates, plus labelling systems.

Accessories for modular disconnect test terminals

page 1.20

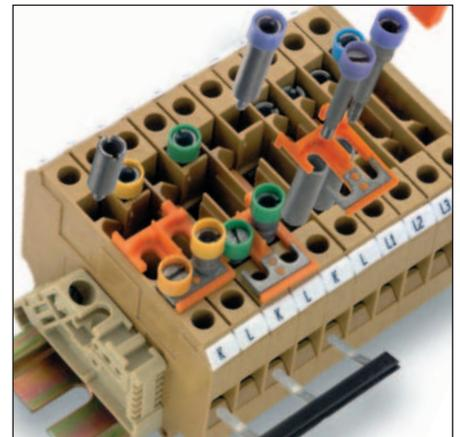

Special applications call for special solutions.

Visual separation – side covers

End clamp plates

End clamp plate with mounting bracket EP ... /32

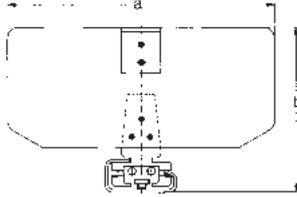

End clamp plate with mounting bracket EP ... /35

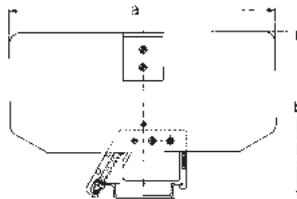

Strain relief clip

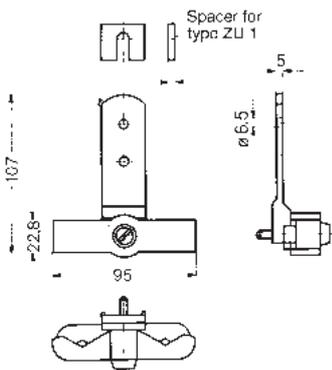

Strain relief clip for gripping cables up to 30 mm dia. Attach the strain relief clip between TS and mounting surface using the TS fixing screw. Fit the spacer to suit with the second fixing screw.

EP end clamp plates

Type	a	b	Order No.	for terminal type:
EP 1	120	75.5	0271800000	SAKG 28 and SAKG 70
EP 2	160	90.5	0271900000	SAKG 32, 40, 46 and 54
EP 1/35	120	76.5	1381600000	SAKG 32 and SAKG 70
EP 2/35	160	91.5	0182000000	SAKG 32, 40, 46 and 54

ZU 1

Material	Qty	Order No.
ZU 1	2	0240600000

Colour coding options

End cover plates



Protection against contact with live parts

Apart from a few exceptions, the last terminal of a terminal strip must be covered with an AP end cover plate. And end cover plates are also required within a terminal strip containing terminals of different sizes.

This guarantees protection against contact with live parts. The modular terminals are finger-touch safe (to DIN VDE 0106-100).

Visual separation

Coloured end cover plates are frequently used to create a visual distinction between different circuits.

Guaranteeing the operating voltage

End cover plates can also be used to maintain the necessary clearance and creepage values and thus guarantee the operating voltage for the application. For example, if cross-connection sets are positioned directly adjacent one another.

Matching profiles

The overall dimensions of the end cover plates match the sizes of the associated terminals.

Installation

Spigots on the end cover plate enable it to be simply clipped into the corresponding modular terminal. The matching holes in the modular terminal ensure that the end cover plate is positioned exactly to match the profile of the terminal.

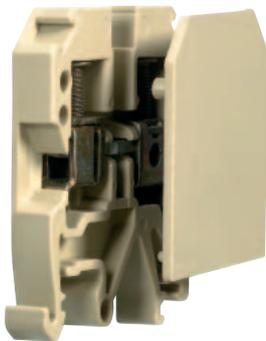

Visual separation – side covers

Type	Colour	Qty	Order No.
AP SAK4-10 DB	dark beige	20	0105100000
AP SAK4-10 OR	orange	20	0105160000
AP ASK1 OR	orange	20	0105360000
AP DKT4 PA	beige	20	0687560000
AP AKZ2.5K	beige	50	0697260000
AP AKZ2.5	beige	50	0697360000
AP DKIT4	beige	20	0635060000
AP SAK4-10 RT	red	20	0117900000
AP SAK4-10 KRG/BL	blue	20	0117970000
AP SAK4-10 BL	blue	20	0117980000
AP SAKH 4EX	black	20	0408730000
AP SAKH6-10 EP/SW	black	20	0131700000
AP DUSA4/35	beige	20	0401360000
AP SAKB/C/T BE	beige	20	0146760000
AP SAKD2.5N BL	blue	20	0150980000
AP AKA2.5 KRG/BL	blue	50	0162570000
AP SAK4-10 KRG/DB	dark beige	20	0177600000
AP SAKS1+3 KRG/DB	dark beige	20	0191300000
AP SAKR BE	beige	20	0211360000
AP 70 SAK70 KRG	dark beige	10	0340920000
AP SAKR BL	blue	20	0211380000
AP AKZ1.5	beige	50	0340560000
AP SAK70/35	beige	10	0340960000
AP AST1+5 DB	dark beige	20	0266400000
AP ASK1	beige	20	0380360000
AP SAK16 BL	blue	20	0271180000
AP DK4	beige	20	0359260000
AP SAK2.5 GE	yellow	20	0279500000
AP SAK2.5 OR	orange	20	0279540000
AP SAK2.5 KRG BL	blue	20	0279570000
AP SAK2.5 BL	blue	20	0279580000
AP AKZ4 BL	blue	20	0294480000
AP SAK95 KRG	blue	10	0550920000
AP DSK1.5	beige	20	0532960000
AP SAK35 KRG/BL	blue	10	0303670000
AP DK4S	beige	20	0631360000
AP SAK35/TW SAK16 BL	blue	10	0303680000
AP SAK2.5L KRG BL	blue	20	0309270000
AP ADK1	beige	50	0476260000
AP AKZ1.5 BL	blue	50	0340580000
AP SAK2.5/35 + AST3+4	beige	20	0460560000
AP TOP4SF-FF	beige	20	0483460000
AP DK4 BL	blue	20	0359280000
AP ASK1 RT	red	20	0380350000
AP ASK1 BL	blue	20	0380380000
AP DLD2.5/PE	beige	20	1595960000
AP VLI1.5/PE	beige	20	1633320000
AP VLI1.5	beige	20	1633260000
AP MAK2.5	beige	20	1615280000
AP DK4Q	beige	20	1397160000
AP DLI2.5	beige	20	1313260000
AP DLD2.5	beige	20	1317660000
AP ST5 PPO/SW	black	10	0447240000
AP ST5 PA/BE	beige	10	0447260000
AP SAK2.5/35 DB	dark beige	20	0460490000
AP TW/SS.../35	beige	10	1333200000
AP SAK2.5/35 BL	blue	20	0460580000
AP SAKS1+3 KRG	dark beige	20	0191320000
AP SAKD2.5N	beige	20	0150960000
AP SAKR KRG	dark beige	20	0211320000
AP TAL	beige	20	0212260000
AP SAKA KRG	dark beige	20	0134220000
AP SAK95 KRG/BL	blue	10	0550970000
AP SAKH6-10 KRG	dark beige	20	0131720000
AP SAKB/C/T KRG	dark beige	20	0146720000
AP AKA2.5	beige	100	0162520000
AP DK4Q DB	dark beige	20	0631300000
AP DK4S BL	blue	20	0631380000
AP AKZ4	blue	20	0294460000
AP AKZ4 KRG	dark beige	20	0294420000
AP SAK35/TW SAK16	beige	10	0303660000

Type	Colour	Qty	Order No.
AP SAK35 KRG	dark beige	10	0303620000
AP AKZ2.5 BL	blue	50	0697380000
AP RSF2 KRG	dark beige	10	0301420000
AP SAK2.5	beige	20	0279560000
AP SAK2.5 KRG	dark beige	20	0279520000
AP DLD2.5 BL	blue	20	1317680000
AP AKZ1.5W	beige	20	0329660000
AP SAKT2 KRG	dark beige	20	0329120000
AP AST3+4 KRG	dark beige	20	0298120000
AP DK4Q BL	blue	20	1397180000
AP SAK2.5L KRG	dark beige	20	0309220000
AP RSF3	beige	10	0270460000
AP RSF1 KRG	dark beige	10	0270420000
AP AST1+5 KRG	dark beige	20	0266420000
AP AST1+5	beige	20	0266460000
AP SAK16 KRG	dark beige	20	0271120000
AP SAKT4 KRG	dark beige	20	0244920000
AP SAK16	beige	20	0271160000
AP SAK4-10	beige	20	0117960000
AP SAK4-10 KRG	dark beige	20	0117920000
AP SAK4-10 I	beige	20	0117910000
AP ASK1 DB	dark beige	20	1753320000
AP 100 GR	grey	20	1773410000
AP DLI2.5 DB	dark beige	20	1783550000
AP DLD2.5/PE DB	dark beige	20	1783800000
AP VLI1.5 DB	dark beige	20	1784150000
AP VLI1.5/PE DB	dark beige	20	1784160000
AP DLD2.5 DB	dark beige	20	1784210000
AP 110 GR	grey	10	1790080000
AP SAKR BE RS-SET	beige	5	1820200000
AP SAK4-10 GR 7042	grey	20	1853970000
AP 2 DSG1.5T	beige	1	2119490000
AP PPT/35	black	10	3835120000
AP RV	beige	1	4145220000
AP OSC 10/16	beige	10	9154850000
AP OSC 4	beige	10	9154860000
AP STA2.5 0.5MM	beige	1	2012770000
AP KDKS1 1.5	beige	20	9503330000
AP KDKS1 EN	beige	20	9503340000
AP KSKM	beige	20	9509630000
AP SAK4-10 GE	yellow	1	2076890000
AP SAK16 GE	yellow	1	2076900000
AP SAK35/TW SAK16 GE	yellow	1	2076910000
AP AST3+4/35 GE	yellow	1	2077060000
AP AKZ4 GE	yellow	50	2077070000
AP SAK2.5/35	beige	1	2144900000
AP ATA1	beige	1	2093550000
AP SAK4 KRG M.FU	dark beige	20	0460020000
AP DK4/380 Q	beige	20	0438560000
AP SAKB/C/T BE	beige	1	4140450000
AP SAKB/C/T1 DB	dark beige	1	4173520000
AP MAK2.5 DB	dark beige	20	7917000000
AP SAKK4/10 KER/WS	white	10	9502630000
AP KDKS1 1.5 DB	dark beige	20	9532470000

Colour coding options

Colour coding options



The colours listed here are available as standard. Other types of terminals in custom colours can be supplied on request, provided a minimum quantity is ordered.

Type	Colour	Qty	Order No.
SAK 2.5 AL BLUE (E)	blue	100	6253140000
SAK 2.5 BL	blue	100	0279680000
SAK 2.5 BL RS-SET	blue	10	1817860000
SAK 2.5 KRG/BL	blue	100	0279670000
SAK 2.5 OR	orange	100	1326360000
SAK 2.5 SW 1X1	black	100	0108560000
SAK 2.5 SW 1X1/KRG	black	100	0108520000
SAK 2.5/35 BL	blue	100	0380480000
SAK 2.5/35 DBL	blue	100	1799920000
SAK 2.5/35 GE	yellow	100	1821480000
SAK 2.5/35 KRG/BL	blue	100	0380470000
SAK 2.5/35 OR	orange	100	0380440000
SAK 2.5/35 RT	red	100	1799910000
SAK 2.5/35 SW	black	100	1799900000
SAK 2.5/35 SW 1X1	black	100	0514060000
SAK 2.5/EN BL	blue	100	0218680000
SAK 2.5/EN BR	brown	100	1858450000
SAK 2.5/EN SW	black	100	1858440000
SAK 2.5/EN WS	white	100	1858460000
SAK 2.5/TC AL BL	blue	100	0107180000
SAK 2.5/TC CH BL	blue	100	0107280000
SAK 35/35 BL	blue	20	0380780000
SAK 35/EN BL	blue	20	1784400000
SAK 4 BL	blue	100	0128380000
SAK 4 BL RS-SET	blue	10	1817780000
SAK 4 EP/SW	black	100	0128300000
SAK 4 KRG BL	blue	100	0128370000
SAK 4 OR	orange	100	0105060000
SAK 4 SS/35 6.3 GR	grey	100	0646930000
SAK 4/35 BL	blue	100	0443680000
SAK 4/35 KRG/BL	blue	100	0443670000
SAK 4/35 OR	orange	100	1323660000
SAK 4/35/AP GG	grn/yell	100	0443650000
SAK 4/EN BL	blue	100	0467480000
SAK 4/EN BR	brown	100	9130990000
SAK 4/EN GE	yellow	100	9129930000
SAK 4/EN GN	green	100	9129950000
SAK 4/EN GR	grey	100	9129960000
SAK 4/EN GR 7042	grey	100	1853950000
SAK 4/EN OR	orange	100	0467400000
SAK 4/EN RT	red	100	9129920000
SAK 4/EN SW	black	100	9130980000
SAK 4/EN WS	white	100	1773340000
SAK 6/35 BL	blue	100	0380580000
SAK 6/35 GN/GE	yellow	100	1866850000
SAK 6/35 KRG/BL	blue	100	0380570000
SAK 6/EN BL	blue	100	0212880000
SAK 6/EN GE	yellow	100	1772820000
SAK 6/EN OR	orange	100	1772810000
SAK 6/EN RT	red	100	0212840000
SAK 6/EN SW	black	100	0212810000
SAK 6/EN WS	white	100	1773350000
SAK 6N BL	blue	100	0193280000
SAK 10 BL	blue	100	0110080000
SAK 10 KRG/BL	blue	100	0110070000
SAK 10 OR	orange	100	0110040000
SAK 10/35 BL	blue	100	0443780000
SAK 10/35 KRG/BL	blue	100	0443770000
SAK 10/EN BL	blue	100	1784410000
SAK 10/EN GR RAL 7042	grey	100	1853960000
SAK 10/EN OR	orange	100	1772830000
SAK 10/EN SW	black	100	1773900000
SAK 16 BL	blue	50	0271080000
SAK 16/35 BL	blue	50	0380680000
SAK 16/EN BL	blue	50	1784390000
SAK 70 KRG/BL	blue	10	0340870000
SAK 95/35 KRG/BL	blue	10	0662270000
SAKC 4/2STB7 BL	blue	100	0340670000
SAKD 2.5/35 BL	blue	100	0268880000
SAKD 2.5N BL	blue	100	0215580000
SAKH 6 EP/SW	black	50	0126600000

Type	Colour	Qty	Order No.
SAKH 10 EP/SW	black	50	0126700000
SAKH 35 EP/SW	black	20	1596240000
SAKR 2STB BL	blue	100	0412280000
SAKR BL	blue	100	0412180000
SAKR OR	orange	100	1461960000
SAKR/35 2STB BL	blue	100	0183380000
SAKR/35 BL	blue	100	0172180000
SAKR/35 WS	white	100	0172190000

Potential distribution

Cross-connection systems

Cross-connections across more than 10 modular terminals

The SAKD 2.5 N, SAK 2.5, SAK 4 and SAK 6 N terminals include the option of setting up a cross-connection with more than 10 poles, e.g. 20-pole: 2 No. Q 10 + 1 No. QL 2.

The end fixing screws are removed from the Q 10 links by unscrewing them from the VH sleeves. The QL 2 is positioned between these and the two fixing screws screwed into their VH sleeves again. This arrangement allows 20 poles to be cross-connected.

Q pre-assembled cross-connectors

The pre-assembled cross-connector has the appropriate number of cross-connection links, cross-connection sleeves and fixing screws to match the number of poles required already installed in a captive arrangement. Such pre-assembled cross-connectors merely have to be inserted into the appropriate terminals during installation. These cross-connectors can be supplied in 2-, 3-, 4- and 10-pole versions.

QL cross-connection links

Cross-connection links are used to provide cross-connections with equal potential across several modular terminals. The cross-connection links are made from copper or brass with an electroplated tin coating, and can be supplied in lengths to suit 2, 3, 4 and 10 poles, to match the respective terminal width. The electrical connection between the cross-connection link and the busbar of the modular terminal is by way of a connecting sleeve.

BS fixing screws

A steel fixing screw is used to connect the cross-connection link to the connecting sleeve on the busbar under a modular terminal. It is the purpose of the steel screw to provide a secure mechanical fixing between the cross-connection and the busbar. Two types of screw are used: form A has a full-length thread, and form B has a plain shaft below the head with a captive washer.

VH connecting sleeves

The length of the connecting sleeve is matched to the size of the terminal. The sleeves are made from tin-coated copper or brass. One connecting sleeve must be used for every terminal to be cross-connected.

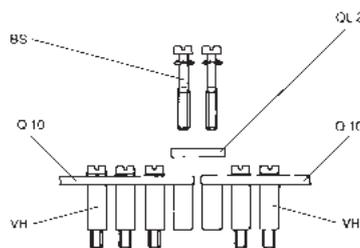
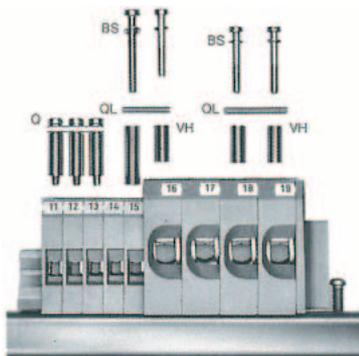

Potential distribution

Cross-connection systems

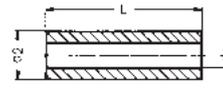
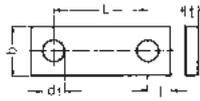

Type	Rated current of modular terminals	Pre-assembled cross-connection		Cross-connection links						Continuous current rating of cross-connection	Connecting sleeves without thread			Fixing screws					
		Type Poles	Order No.	Type Poles	Order No.	Dimensions					Type Length	Order No.	L	d2	d1	Order No.	Size Form	M	
SAK 2.5	24 A	Q 2	037000000	QL 2	015590000	6	0.6	6	3.4	2.4	32 A	VH 8	026670000	8	4.9	3.2	035900000	B	3 x15
		Q 3	371000000	QL 3	015600000						32 A								
		Q 4	372000000	QL 4	015610000						32 A								
		Q 10	036870000	QL 10	033810000						32 A								
SAK 4	32 A	Q 2	033670000	QL 2	013060000	6	0.6	6.5	3.4	2.5	41 A	VH 13.5	024850000	13.5	5	3.2	030300000	B	3x20
		Q 3	033680000	QL 3	013070000						41 A								
		Q 4	033690000	QL 4	013080000						41 A								
		Q 10	036880000	QL 10	033820000						36 A								
SAK 6 N	41 A	Q 2	045670000	QL 2	019430000	6	1	8	3.4	3	41 A	VH 12	024900000	12	5	3.2	030300000	B	3x20
		Q 3	045680000	QL 3	019440000						41 A								
		Q 4	045690000	QL 4	019450000						41 A								
		Q 10	045700000	QL 10	033830000						41 A								
SAK 10	57 A	Q 2	045710000	QL 2	047030000	6	2	10	3.4	3.5	57 A	VH 12	024900000	12	5	3.2	030300000	B	3x20
		Q 3	045720000	QL 3	047040000						57 A								
		Q 4	045730000	QL 4	047050000						57 A								
		Q 10	045740000	QL 10	047060000						57 A								
SAK 16	76 A	Q 2	045750000	QL 2	047070000	6	2	12	3.4	4	76 A	VH 12	024900000	12	5	3.2	030300000	B	3x20
		Q 3	045760000	QL 3	047080000						76 A								
		Q 4	045770000	QL 4	047090000						76 A								
		Q 10	045780000	QL 10	047100000						76 A								
SAK 35 N	125 A			QL 2	056490000	8	3	16	4.5	5	99 A	VH 17	026700000	17	8	5	026710000	A	4x30
				QL 3	056500000						99 A								
				QL 4	056510000						99 A								
				QL 10	056520000						99 A								
SAK 35	125 A			QL 2	012360000	8	3	18	4.5	5	99 A	VH 17	026700000	17	8	5	026710000	A	4x30
				QL 3	012370000						99 A								
				QL 4	012380000						99 A								
				QL 10	033860000						99 A								
SAK 70	192 A			QL 2	034530000	14	4	22	5.5	7	180 A	VH 30.5	034550000	30.5	11	5.5	034560000	A	5x45
				QL 3	016700000						180 A								
SAK 95	232 A			QL 2	055120000	14	4	28	6	7	180 A	VH 35	055110000	35	11	5.5	063020000	B	5x50
				QL 3	040760000						180 A								
				QL 4	040770000						180 A								
SAKS 1	6,3 A			QL 2	019140000	6	2	12.9	3.4	3	47 A					346200000	B	3 x 6	
SAKS 3	10 A			QL 3	019150000														
SAKS 6	10 A			QL 4	019160000														
SAKS 7	10 A			QL 10	033880000														
SAKS 4	16 A			QL 2	032800000	10	4	24	4.8	5	47 A						019970000	A	3 x 7
				QL 3	032810000						47 A						010330000	A	4 x 9
				QL 4	032820000						47 A								
				QL 10	033900000						36 A								
SAKS 2	10 A			QL 2	020780000	10	4	27.6	4.8	6.5	47 A					010330000	A	4 x 9	
SAKS 5	63 A			QL 3	020790000						47 A								
				QL 4	020800000						47 A								
				QL 10	033890000						36 A								
DK 4 Q	41 A	Q 2	033640000	QL 2	029720000	4	0.8	6.1	2.8	2.5	32 A	VH 5	029680000	5	4	2.7	040010000	B	2.5x11
DKB 4 Q/10	41 A	Q 3	033650000	QL 3	029730000														

Potential distribution

Cross-connection systems

Cross-connections between terminals of different sizes to increase the cross-section

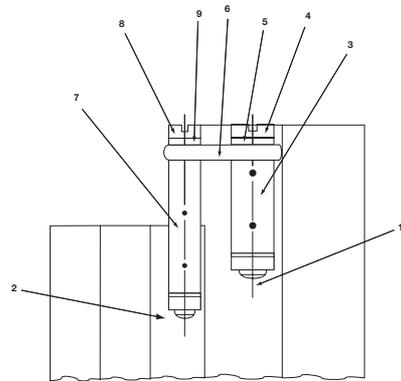
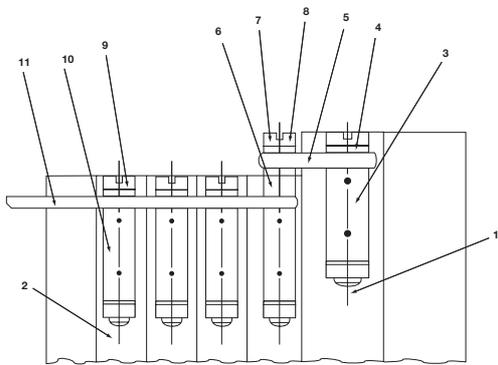

Terminal	Position	Type	Order No.	Current
from SAK 16	1	-	-	-
	3	VH 12	0249000000	-
	4	BS M 3 x 20	0303000000	-
to SAK 6 N	2	-	-	-
	5	QL 2	0470300000	-
	6	VH 4,5	0303200000	-
	7	BS M 3 x 25	0292500000	-
	8	SS M 3	0164400000	-
	9	BS M 3 x 20	0303000000	-
	10	VH 12	0249000000	-
	11	QL 2	0194300000	47 A
	11	QL 3	0194400000	47 A
	11	QL 4	0194500000	47 A
	11	QL 10	0338300000	36 A
to SAK 2.5	2	-	-	-
	5	QL 2	0470300000	-
	6	VH 12	0249000000	-
	7	BS M 3 x 30	0296200000	-
	8	SS M 3	0164400000	-
	9	BS M 3 x 15	0359000000	-
	3	VH 12.5	0308000000	-
	3	VH 8	0266700000	-
	11	QL 2	0155900000	27 A
	11	QL 3	0156000000	27 A
	11	QL 4	0156100000	27 A
	11	QL 10	0338100000	27 A
from SAK 10	1	-	-	-
	4	BS M 3 x 20	0303000000	-
to SAK 4	2	-	-	-
	3	VH 13.5	0248500000	-
	5	QL 2	1443000000	-
	7	BS M 3 x 20	0303000000	-
	9	BS M 3 x 20	0303000000	-
	10	VH 13.5	0248500000	-
	11	QL 2	0130600000	36 A
	11	QL 3	0130070000	36 A
	11	QL 4	0130800000	36 A
	11	QL 10	0338200000	36 A
to SAK 2.5	2	-	-	-
	5	QL 2	0193400000	36 A
	1	VH 13	0304000000	-
	4 + 7	BS M 3 x 20	0303000000	-
	9	BS M 3 x 15	0359000000	-
	10	VH 8	0266700000	-
	11	QL 2	0155900000	27 A
	11	QL 3	0156000000	27 A
	11	QL 4	0156100000	27 A
	11	QL 10	0338100000	27 A
	3	VH 13	0304000000	-
	3	VH 6.5	0286400000	-

Terminal	Position	Type	Order No.	Current
from SAK 35	1	-	-	-
	3	VH 17	0267000000	-
	4	BS M 4 x 30	0267100000	-
	5	SS M 4	0136400000	-
to SAK 10 N	2	-	-	-
	5	QL 2	0207400000	47 A
	6	VH 4,5	0303200000	-
	8	BS M 3 x 35	0309800000	-
	9	SS M 3	0164400000	-
to SAK 6 N	2	-	-	-
	6	QL 2	0207400000	47 A
	7	VH 27	0309400000	-
	8	BS M 3 x 35	0309800000	-
	9	SS M 3	0164400000	-
from SAK 35 N	1	-	-	-
	3	VH 17	0267000000	-
	4	BS M 4 x 30	0267100000	-
	5	SS M 4	0136400000	-
to SAK 10	2	-	-	-
	6	QL 2	0207400000	47 A
	7	VH 27	0309400000	-
	8	BS M 3 x 35	0309800000	-
	9	SS M 3	0164400000	-
to SAK 6 N	2	-	-	-
	6	QL 2	0135500000	47 A
	7	VH 27	0309400000	-
	8	BS M 3 x 35	0309800000	-
	9	SS M 3	0164400000	-
from SAK 10	1	-	-	-
	3	VH 12.5	0300800000	-
	4	BS M 3 x 20	0303000000	-
	5	SS M 3	included	-
to SAK 35 N	1	-	-	-
	3	VH 13	0304000000	-
	4	BS M 3 x 20	0303000000	-
	5	SS M 3	included	-
to SAK 2.5	2	-	-	-
	6	QL 2	0130600000	27 A
	7	VH 16	0309700000	-
	8	BS M 3 x 20	0303000000	-
	9	SS M 3	included	-

Potential distribution

Screw-in cross-connectors (Q)

In this type of cross-connection the cross-connection link, connecting sleeves and fixing screws are pre-assembled in a captive arrangement. However, all the individual parts are also available separately on request. During installation, these pre-assembled cross-connectors are simply inserted into the cross-connection slot in the middle of the terminal and screwed tight. Any number of poles can be achieved by linking two cross-connections. For example, a 20-pole cross-connection by joining together two 10-pole cross-connections with the cross-connection link of a 2-pole cross-connection (see figure below).

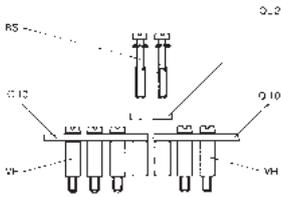

Technical specification

continuous current, 2-pole/multi-pole	A
thread size	
tightening torque	Nm

Ordering data

2-pole	
3-pole	
4-pole	
10-pole	
24-pole	

Q ... AKZ 4SS



Technical specification

32 / 32	
M 2.5	
0.4 ... 0.6	

Ordering data

Type	Qty	Order No.
Q...2 AKZ 4SS		0369000000
Q...3 AKZ 4SS		0369100000
Q...4 AKZ 4SS		0369200000
Q...10 AKZ 4SS		0369300000

for terminal

AKZ 4SS

Q ... DLI 2.5



Technical specification

24 / 24	
M 2.5	
0.4 ... 0.6	

Ordering data

Type	Qty	Order No.
Q...2 DLI 2.5		1312500000
Q...3 DLI 2.5		1312600000
Q...4 DLI 2.5		1312700000
Q...10 DLI 2.5		1313100000

for terminal

DLI 2.5
DLA 2.5
DLD 2.5

Q ... AKZ 1.5



Technical specification

continuous current, 2-pole/multi-pole	A
thread size	
tightening torque	Nm

Ordering data

2-pole	
3-pole	
4-pole	
10-pole	
24-pole	

Technical specification

24 / 24	
M 2.5	
0.4 ... 0.6	

Ordering data

Type	Qty	Order No.
Q...2 AKZ 1.5	50	0368200000
Q...3 AKZ 1.5	50	0368300000
Q...4 AKZ 1.5	50	0368400000
Q...10 AKZ 1.5	20	0368500000

for terminal

AKZ 1.5
AKZ 2.5

Q ... AKZ 4



Technical specification

32 / 32	
M 2.5	
0.4 ... 0.6	

Ordering data

Type	Qty	Order No.
Q...2 AKZ 4	50	0336400000
Q...3 AKZ 4	50	0336500000
Q...4 AKZ 4	50	0336600000
Q...10 AKZ 4	20	0338600000

for terminal

AKZ 4

Potential distribution

Removable cross-connection links

Removable cross-connection links are intended for 2-pole, easily disconnected cross-connections. They are fitted together with a VH connecting sleeve and a BS fixing screw.

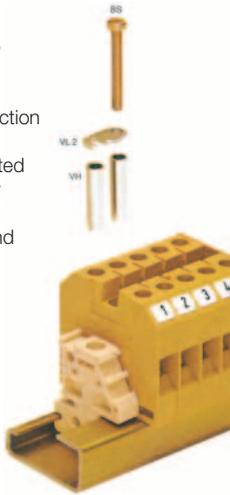

VL 2

Removable cross-connection links



for terminal
SAK 4
SAK 6 N
SAK 10
SAK 16
SAK 35

Type	Qty	Order No.
VL 2	50	0197000000
VL 2	50	0194700000
VL 2	50	0135900000
VL 2	50	0135800000
VL 2	50	0124000000

VH

Connecting sleeves



Type	Qty	Order No.
VH 19	50	0285100000
VH 19	50	0285100000
VH 19	50	0285100000
VH 19	50	0285100000
VH 24,5	50	0298700000

BS

Fixing screws



Type	Qty	Order No.
BS M3x25	100	0292500000
BS M3x25	100	0292500000
BS M3x25	100	0292500000
BS M3x25	100	0292500000
BS M4x35	50	0298900000

Spacer pillars

The DS spacer pillars are made from a tempered insulating material and are used so that individual current paths can be disconnected by removing the fixing screw. The current in the cross-connection is fed via the fixing screw in this arrangement. Therefore, we prescribe the use of screws made from CuNi 60 (a copper-nickel alloy). The use of an end bracket with a screw holder avoids losing fixing screws that have been removed.

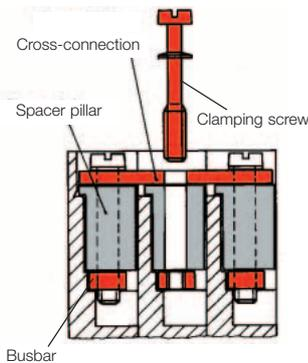

Spacer pillars type DS

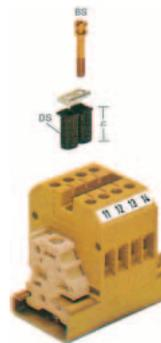

for terminal
SAK 2.5
SAK 4
SAK 6 N
SAK 10 and SAK 16

Type	Qty	Order No.
DS 9*	100	0330930000
BS M3x15 CuNi	100	0377200000
DS 14*	100	0207530000
BS M3x20 CuNi	100	0377100000
DS 12.5*	100	0207730000
BS M3x20 CuNi	100	0377100000
DS 12.5*	100	0207630000
BS M3x20 CuNi	100	0377100000
* Height in mm		

EW 35

End bracket for TS 35 with screw holder for fixing screws that have been removed.



Type	Qty	Order No.
EW35/TS 35 20 with screw holder	100	0258660000

EWK 2

End bracket for TS 32 with screw holder for fixing screws that have been removed.



Type	Qty	Order No.
EWK 2/TS 32 20 with screw holder	100	0258760000

Rail holder

For an insulated terminal rail arrangement in fully insulated installations.



for terminal
EK 2.5 N, EK 2.5/35, EK 4, EK 4/35, EK 6/35, EK 10, EK 10/35, EK 16, EK 16/35, EK 35, EK 35/35

Type	Qty	Order No.
SH2	10	0494920000

Potential distribution

Cross-connection combs

Cross-connection combs are fitted externally and enable current splitting at modular terminals that do not have a cross-connection slot in the middle of the terminal or that those where two potentials have to be fed in parallel. Types QB 2, 3 and 4 are insulated cross-connection combs. Types QB 58 and 75 are supplied in 58- and 75-pole versions respectively.

The poles are easily broken out/off manually. Push-on insulation for subsequent shock protection is available for both pitches. When using such external cross-connectors, the rated cross-section is reduced to the next smaller conductor size.

QB 2-, 3- and 4-pole

angled

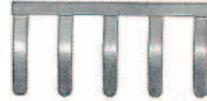
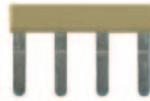

Cross-connection comb

insulated	
pitch (mm)	pitch (mm)
8.0	6.0 und 6.5

QB 58, QB 75

Cross-connection comb

uninsulated (available with insulation as shock protection on request)	
pitch (mm)	pitch (mm)
8.0	6.0
e.g. SAK 6	e.g. SAK 2.5
QB 58	QB 75

Qty	Order No.	Qty	Order No.
10	0545400000 ⁽²⁾		
10	0545300000 ⁽²⁾		
		10	0535200000 ⁽²⁾
		10	0526400000 ⁽²⁾
10	0546000000	10	0526700000
10	0546080000	10	0526780000
10	0546040000	10	0526760000

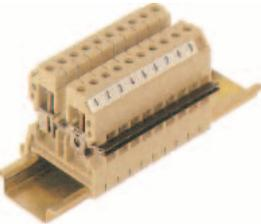

QB 2, 2-pole
 QB 3, 3-pole
 QB 4, 4-pole
 QB 58-pole, straight
 QB 58-pole, angled
 QB 75-pole, straight
 QB 75-pole, angled

black insulation
 blue insulation
 red insulation

Qty	Order No.	Qty	Order No.
50	0461100000 ⁽¹⁾	50	0482700000 ⁽¹⁾
50	0461200000 ⁽¹⁾	50	0482800000 ⁽¹⁾
50	0461300000 ⁽¹⁾	50	0482900000 ⁽¹⁾

⁽¹⁾ Current-carrying capacity 27 A

⁽²⁾ The mounting tolerances of the terminals must be taken into account.

Plug-in cross-connectors type QS and DQS

QS and DQS plug-in cross-connectors are used in conjunction with sockets to create easily disconnected cross-connections between modular terminals.

DQS 2

for 2.3 mm dia. sockets

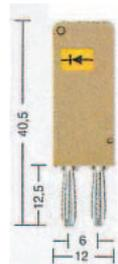

QS 2

for 2.3 mm dia. sockets

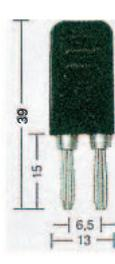

QS 2

for 4 mm dia. sockets, for up to 44 A

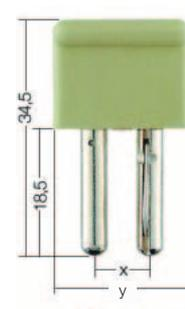

Type	Qty	Order No.
for 6 mm terminal width (e.g. SAK 2.5) with jumper/as test plug with diode 1 N 4007	20	0471560000
without diode	20	0471460000
for 6,5 mm terminal width (e.g. SAK 4)	20	0471660000
for 8 mm terminal width (e.g. SAK 6 N)	20	0212700000
for 10 mm terminal width (e.g. SAK 10)		
for 12 mm terminal width (e.g. SAK 16)		

Type	Qty	Order No.
DQS 2 (2-pole) for up to 20 A	20	0471560000
DQS 2 (2-pole) max. 1 A	20	0471460000
DQS 2 (2-pole) installation space 9 x 9 x 4.5	20	0471660000
QS 2 (2-pole) for up to 20 A	20	0212700000

Type	Qty	Order No.
QS2 (2-pole) dim. x = 8 mm, y = 16 mm	20	0270960000
QS 2 (2-pole) dim. x = 10 mm, y = 20 mm	20	0270860000
QS 2 (2-pole) dim. x = 12 mm, y = 20 mm	20	0270760000

Testing/Checking

Test plugs/Sockets

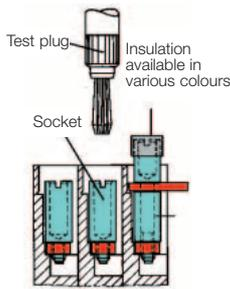

Test plugs (PS) are used for measurement purposes or for the final checking of a finished terminal strip installation. Test plugs for sockets are available with 2.3 and 4 mm I.D.

The difference between these and a test adapter is that the test plug does not automatically clip into the terminal. This means that a secure connection to modular feed-through terminals up to 35 mm² is only possible in conjunction with a socket.

The **sockets (StB)** enable the PS test plug and the QS plug-in cross-connectors to be plugged in. The sockets are screwed into the busbar in the cross-connection slot in the middle of the terminal or screwed into the modular terminal instead of the clamping screw.

If a cross-connection has to provide a test option as well, then an StB 28.5 or 30.5, which has an insulating sleeve and can accommodate the PS 4 test plug, is screwed in instead of the fixing screw.

PS



Type	Qty	Ordner No.
2.3 mm dia./rated current 17.5 A PS 2.3	20	0180400000
4.0 mm dia./rated current 24 A PS 4	20	0299600000

PS 2 / PS 2 MC



Type	Qty	Ordner No.
PS 2 for 2 mm dia. sockets for soldered conductor cross-section 1.5 mm ²	20	0293800000
PS 2 MC for soldered conductor cross-section 0.75 mm ² , can also be plugged directly into threaded hole in busbar for terminal types AKZ 4, AKB 4, AKZ 2.5, AKZ 1.5	20	0310000000

ZS 2.3/4



Type	Qty	Ordner No.
ZS 2.3/4 Adapter plug for connecting sockets with 2.3 and 4 mm I.D. Can also be plugged directly into threaded hole in busbar for terminal types SAK 2.5 and SAK 4.	20	0249600000

FZS 2/4 / FK 4



Type	Qty	Ordner No.
FZS 2/4 Flexible adapter plug for connecting sockets with 2.3 and 4 mm I.D.	20	1276300000
FK 4 Flexible coupling for connecting test plug to test adapter. The unconnected end of the conductor is protected against fraying by a wire end ferrule.	20	1678650000

TA 1



Type	Qty	Ordner No.
TA 1 The conductor is soldered on, or crimped on with the HTG 58 crimping pliers.	20	0535860000
HTG 58 conductor: max. 0.75 mm ² remove shoulder stripping length: 14 mm	1	9012000000

Testing/Checking

The SAKR modular disconnect terminals are available already fitted with sockets (see "Modular disconnect terminals"). These sockets are provided with a slot for actuating with a screwdriver. Weidmüller can supply special screwdrivers with a shoulder for this purpose (chapter J).

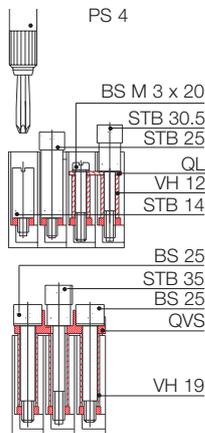

StB for SAKT

The type StB 25 socket accepts test plug PS 4 in type SAKT 1 and SAKT 2 disconnect terminals, or the QS plug-in cross connector.

The type StB 35 socket is used when simultaneous testing is necessary with a QVS cross-connection slider.

Complete with insulating sleeve to prevent contact with live parts and colour-coded test plug and plug-in cross-connection, 4 mm dia.

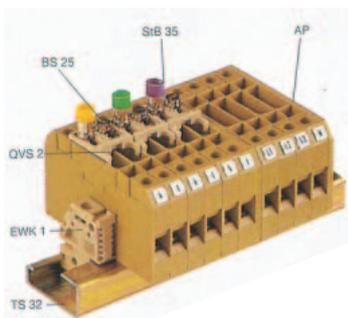

StB 5.5...17

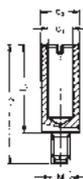

Type	for terminal type	L1	L2	d1	d2	M	Qty	Order No.
StB 5.5	SAKL 4/20 ¹⁾	5.5	11	2.3	3.7	3	100	0122700000
StB 6	AKZ 4, DK 4, SAKR ¹⁾	6	11.5	2.3	3.9	3	100	0379400000
StB 6	SAK 2.5 ¹⁾	6	13	2.3	3.9	2.5	50	0130200000
StB 7	SAKC4, SAK4 ¹⁾	7	14.5	2.3	4	3	100	0358500000
StB 7.5	SAK 10, SAKB 10 ¹⁾	7.5	17	4	6	4	50	0130000000
StB 8.5	AKZ 4 / DK 4 / SAKD 2.5 N	8.5	11.5	2.3	4	2.5	50	0215700000
StB 8.5	SAK 2.5	8.5	12	2.3	5	3	50	0280600000
StB 8.5	SAKT 4	8.5	12	2	4.5	3	50	0244600000
StB 13.5	SAKA 10 / SAKC 10	13.5	18.5	4	6	4	50	0135200000
StB 14	SAK 4	14	17.5	2.3	5	3	50	0168600000
StB 14	SAK6N, 10, 16 / SAKT 1, SAKT 2	14	19	4	6	3	50	0169900000
StB 16	SAK70, SAK 95	16	28	4	7	5	50	0385400000
StB 16	SAK 35, SAKB 10	16	23	4	7	4	50	0140200000
StB 17	SAKC 10	17	22	4	6	4	50	0147100000

StB 28.5 / 30.5

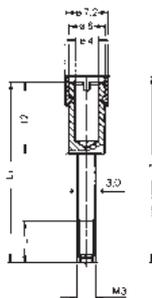

Type	Colour	terminal type	L1	L2	L	Qty	Order No.
StB 30.5	black	SAK 4, SAK 6 N	30.5	31.7	7	50	0341000000
StB 30.5	grey	SAK 10, SAK 16	-	-	-	50	0341100000
StB 30.5	blue	-	-	-	-	50	0341200000
StB 30.5	red	-	-	-	-	50	0341300000
StB 30.5	green	-	-	-	-	50	0341400000
StB 30.5	yellow	-	-	-	-	50	0341500000
StB 30.5	violet	-	-	-	-	50	0341600000
StB 28.5	black	SAK 2.5	28.5	29.7	9	50	0133400000

StB 25



Type	Colour	for terminal type	Qty	Order No.
StB 25	yellow	SAKT 1 and SAKT 2	50	0267200000
	green		50	0271200000
	violet		50	0271300000
	black		50	0271500000
	grey		50	0271400000
	blue		50	0343400000
	red		50	0343300000

StB 35

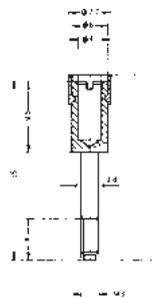

Type	Colour	for terminal type	Qty	Order No.
StB 35	yellow	SAKT 1 and SAKT 2	50	0389000000
	green		50	0388900000
	violet		50	0389100000
	black		50	0388500000
	grey		50	0388600000
	blue		50	0388700000
	red		50	0388800000

¹⁾ used instead of the clamping screw

Protective covers

Protective covers

Several safety regulations, e.g. the German accident prevention code covering electrical systems and equipment (VBG 4) or the standard VDE 0106 part 100 (March 1983), call for live parts of electrical systems to be protected against direct contact by any part of the body.

In the case of modular terminals this protection must always be provided in the form of additional covers when cross-connectors or test sockets are fitted. Therefore, Weidmüller can supply cover strips with associated retaining plates which can be used with the more common sizes of terminal. The retaining plates can be fitted at the ends or within the terminal strip, and can be fitted to TS 32, TS 35 or TS 15 terminal rails.

Spacing of retaining plates:

The length of the ADP 1, 2 and 3 between retaining plates should not exceed about 500 mm. The cover strip is clipped into tabs on the side. Additional security is provided by a spigot on the retaining plate, which can also be sealed with lead. On terminal type SAK 95 the ADP 3 cover strip can be clipped directly onto the terminal. Transparent cover strips enable the terminals with their accessories and labelling to remain visible at all times. Additional labelling, e.g. for groups, can be added.

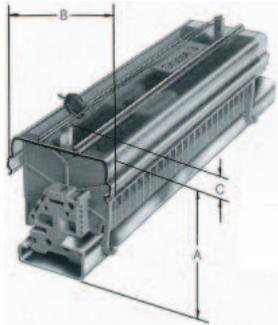

ADP

Cover strips

Unplasticised PVC, supplied in 1 m pieces, max. temperature 70°C

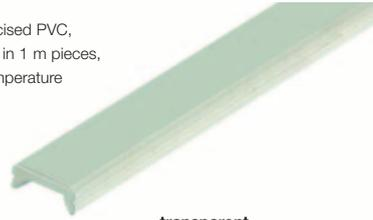

transparent	
Type	Order No.
ADP 1	0485200000
ADP 2	0485300000
ADP 3	0485400000

grey	
Type	Order No.
ADP 4 (1000 mm)	1430760000
ADP 4 (300 mm)	1378160000
TSK 31.5	0347960000

HP

Retaining plates

PA 66, 2 mm thick



For fitting to TS 35 and TS 32, with spigot for lead seal	
Type	Order No.
HP 1	0485560000
HP 2	0485660000
HP 3	0485760000
HP 4	0485860000

For fitting to TS 15	
Type	Order No.
HP 7	0258260000
HP 8	0258360000

Overall dimensions	A	A	A	A	B	C
for mounting on terminal rail	TS 32	TS 35 x 7.5	TS 35 x 15	TS 15		
ADP 1, HP 1	61	56	63		49	6
ADP 2, HP 2	77	72	79		62.5	6
ADP 3, HP 3	94	89	86		92	6
ADP 3, HP 4	73.5	68.5	75.5		92	6
ADP 1, HP 8				45	49	6
TSK 31.5, HP 7				35	31	6

Labelling material	Qty	Order No.
"Lightning flash" symbol, self-adhesive, 20 labels per card	5	0566700000

* only for PA 66 versions

Allocation to some terminal types	ADP cover strips			HP retaining plates		
	Type	Qty	Order No.	Type	Qty	Order No.
SAKD 2.5 N, EK 2.5 N, SAK 2.5, SAK 2.5/35	ADP 1	36	0485200000	HP 1	20	0485560000
SAK 4, EK 4, SAK 4/35, EK 2.5/35, EK 4/35	ADP 2	36	0485300000	HP 2	20	0485660000
SAK 6 N, EK 10, SAK 10, EK 6/35, SAK 6/35, EK 10/35						
SAKR, SAKR-D, DK 4						
SAK 16, EK 16, EK 35, SAK 35, SAKC 4, SAK 16/35	ADP 3	20	0485400000	HP 3	20	0485760000
SAKC 10, SAK 70, SAKS 1, SAKS 2, Sak 35/35, SAK 70/35						
SAKS 3, SAKS 4, SAKS 5						
SAK 95	ADP 3	1	0485400000	not applicable		
ASK 1, SAKA 10, SAKT 1, SAKB 10, SAKT 2,	ADP 3	1	0485400000	HP 4	20	0485860000
AST*, SAK 2.5, SAK 4	ADP 4	1	1430760000	not applicable		
	ADP 1	1	0485200000	HP 8	20	0258360000
1000 mm long	ADP 4	1	1430760000	not applicable		
300 mm long	ADP 4	10	1378160000			
	TSK 31.5	1	0347960000	HP 7	20	0258260000

Protective covers

Several German VDE standards, e.g. VDE 0106 part 100 (March 1983), specify that mains terminals must be covered. Weidmüller can supply a range of such covers printed with a warning "lightning flash" and the international warning symbol. The other side features a "lightning flash" symbol with the warning "Danger! Electricity". Plastic screws are used to fix the cover plates to the terminal strips. The cover plates are intended for 3- or 4-pole terminals.

Type BSK plastic screws are used to fix the plates.
BSK = PA 66

AD/WAD covers



AD 3 (3-pole)

Terminal type	Terminal width (mm)	Qty	Order No.	Screw	Qty	Order No.
SAK 2.5	6	50	0297900000	M 3 x 22	100	0128900000
AKZ 4	6	50	0297900000	M 2.5 x 18	100	0303300000
DK 4 Q	6	50	0297900000	M 2.5 x 18	100	0303300000
SAK 4	6.5	50	0297600000	M 3 x 22	100	0128900000
SAK 6 N	8	50	0297700000	M 3 x 22	100	0128900000
SAK 10	10	50	0178500000	M 3 x 22	100	0128900000
SAK 16	12	50	0297800000	M 3 x 22	100	0128900000
SAK 35 N	18	50	0273400000	M 4 x 32	100	0129100000
SAK 70	22	10	0344300000	M 5 x 45	50	0344400000
Screw for lead seal				M 3 x 20	100	0451300000

AD 3 (4-pole)

SAK 2.5	6	50	0303400000	M 3 x 22	100	0128900000
AKZ 4	6	50	0303400000	M 2.5 x 18	100	0303300000
DK 4 Q	6	50	0303400000	M 2.5 x 18	100	0303300000
SAK 4	6.5	50	0285300000	M 3 x 22	100	0128900000
SAK 6 N	8	50	0196600000	M 3 x 22	100	0128900000
SAK 10	10	50	0178600000	M 3 x 22	100	0128900000
SAK 16	12	50	0518200000	M 3 x 22	100	0128900000
SAK 35	18	50	0178700000	M 4 x 32	100	0129100000
SAK 35 N	16	50	0576700000	M 4 x 32	100	0129100000
Screw for lead seal				M 3 x 20	100	0451300000

TBS 2 / BST 2

for the SAK series

Protective covers

Details

Details

- For covering uninsulated cross-connections on SAK 2.5...SAK 16 terminals.
- Identification of functional groups.
- Easily fitted by inserting the insulating plate into the existing insulating plate slot in the terminal.
- Labelling strips are clipped into the insulating plates.
- Labelling of stable labelling strip with felt-tip pen for permanent labelling or pencil for temporary labelling.



	Order No.
Materials	
Type	
TBS 2, polyamide	
BST 2, unplasticised PVC	
Ordering data	
Type	
TBS insulating plate	1287860000
BST 2 labelling strip (300 mm long)	1287700000

AD

for SAKG

Cover plates

These can be assembled either with two end clamp plates or with one end clamp plate and one partition plate plus mounting bracket.

Cover plates with self-adhesive label

Dimensions of cover plates

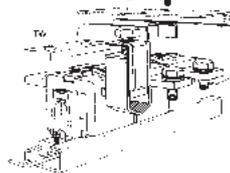

2 mm thick

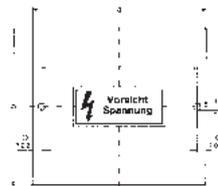

	Type	a	b	c	Order No.
for SAKG 28	AD 3	89	120	74	-
for SAKG 28	AD 4	116	120	102	0263100000
for SAKG 32 and 70	AD 4	132	120	118	0283100000
for SAKG 40	AD 3	124	160	110	-
for SAKG 40	AD 4	164	160	150	0263200000
for SAKG 46	AD 4	188	160	174	0263300000
for SAKG 54	AD 3	166	160	152	0264900000
for SAKG 54	AD 4	220	160	206	0261100000

AH

for SAKG

Shrouding covers

For open-type terminals like type SAKG. Shrouding covers are used – instead of other cover types – to provide the necessary protection against contact (required by German standard VBG 4). Shrouding covers are simply placed over the terminals.

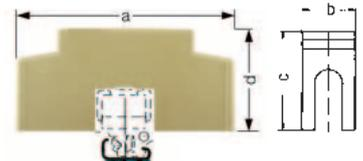
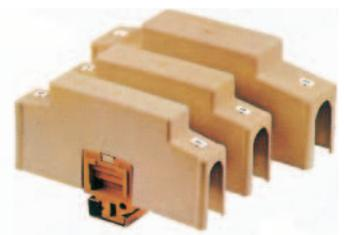

	Type	a	b	c	d	Order No.
dimensions in mm						
for SAKG 28	AH 28	156	26	74	94	0326660000
for SAKG 32/70	AH 32	156	30	74	94	0326760000
for SAKG 40	AH 40	186	38	78	94	0326860000
for SAKG 46	AH 46	196	46	78	94	0326960000

Protective covers

Cover strips for terminal strips

To protect against contact, dust and moisture, Weidmüller can supply cover strips which, for example, are useful in signal or lighting mast distribution boards.

Weidmüller can supply fully assembled and labelled terminal strips to meet your specification.

ADL

The ADL cover can be clipped to a TS 32 terminal rail.

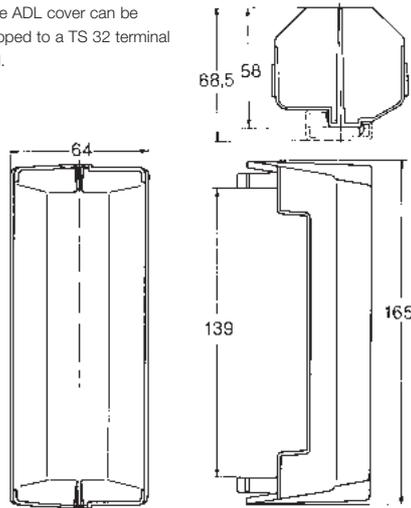

A selection of terminal types that can be fitted below this cover strip:

TS 32

- SAKD 2.5 N ... SAK 10
- EK 2.5 N ... EK 10
- SAKR, ASK 1, SAKT 1, SAKT 4, SAKB 10
- SAKS 1, SAKS 3

Type	Qty	Ordner No.
ADL	2	0210800000

AD 250

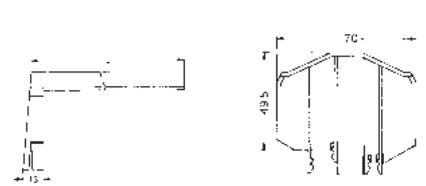

HP

retaining plate
suitable for TS 32 and
TS 35 x 7.5
height for TS 32: 64.5 mm
height for TS 35 x 7.5: 63 mm

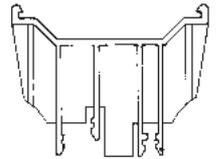

A selection of terminal types that can be fitted below this cover strip:

TS 32

- SAKD 2.5 N ... SAK 10
- EK 2.5 ... EK 10
- SAKR, ASK 1, SAKT 1, SAKB 10
- SAKS 1, SAKS 3

TS 35

- WDU 2.5 bis WDU 10
- WPE 2.5 bis WPE 10
- WNT 2.5 bis WNT 10
- ASK 1,
- SAKS 1/35, SAKS 3/35

Type	Qty	Ordner No.
AD 250 L = 250 mm	1	0634100000
HP EK1 32/2 AD 250	1	0634300000

Accessories for modular disconnect test terminals



QVS... cross-connection sliders

VH 19 connecting sleeves and BS 25 fixing screws (or StB 35 sockets) are required for fixing the QVS cross-connections to the individual terminals.

The fixing screws include an insulating sleeve for colour coding purposes and a guide for the screwdriver. The cross-connection sliders are designed so that the test plug sockets in the terminals remain accessible in every position.

The type QVS 2S 2-pole version is designed so that it can be slid even when a test plug has been inserted. If a test option is required when a QVS has been fitted, the fixing is best achieved with the StB 35 socket.

The clearance and creepage values required for the rated voltage of the terminal change when accessories are fitted.

StB sockets are screwed into the busbar for the modular terminals. They are used to accommodate PS 4 test plugs or QS 2 plug-in cross-connectors.

QVSK 2 (167036)

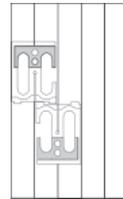

SAKT2, SAKT1

QVS 2 (030730)

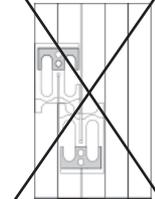

SAKT1

Note:

QVS 2 units cannot be switched when installed like this.

Rated voltages

for adjacent	rated voltage	for adjacent	rated voltage
QVS	63 V	StB 25	63 V
QL	250 V	StB 35	63 V

QVS 1

Cross-connection sliders



QVS QVS QVSK 2 QVS 2S

STB

Sockets



TW partition plates or TSch insulating plates must be used to maintain the rated voltage.

The **SSP 3** and **SSP 4** prevent the unintended making or breaking of circuits. They lock the disconnection slider in its respective position. The lockout device can be easily pressed from above into the terminal and is then only removable with a tool.

Type	Qty	Order No.
SSP 3	100	0531760000
SSP 4	20	1319360000

Type	No. of poles	Qty	Order No.
QVS 2	2 poles	20	0307300000
QVSK 2	2 poles	20	1670360000
QVS 3	3 poles	20	0329300000
QVS 4	4 poles	20	0307400000
QVS 2S	2 poles	20	0358460000

Type	Colour	Qty	Order No.
STB 14		50	0169900000
STB 25			
STB 25	yellow	50	0267200000
STB 25	green	50	0271200000
STB 25	violet	50	0271300000
STB 25	black	50	0271500000
STB 25	grey	50	0271400000
STB 25	blue	50	0343400000
STB 25	red	50	0343300000
STB 30.5			
STB 30.5	yellow	50	0341500000
STB 30.5	green	50	0341400000
STB 30.5	violet	50	0341600000
STB 30.5	black	50	0341000000
STB 30.5	grey	50	0341100000
STB 30.5	blue	50	0341200000
STB 30.5	red	50	0341300000
STB 35			
STB 35	yellow	50	0389000000
STB 35	green	50	0388900000
STB 35	violet	50	0389100000
STB 35	black	50	0388500000
STB 35	grey	50	0388600000
STB 35	blue	50	0388700000
STB 35	red	50	0388800000

Accessories for modular disconnect test terminals

BS fixing screws

VH connecting sleeves

QL cross-connections

The QL cross-connections enable connections between adjacent modular terminals.

QL cross-connection links

QL cross-connection links are used as permanent, i.e. non-switchable, cross-connections on SAKT disconnect terminals. VH 12 connecting sleeves and BS M3 x 20 fixing screws (or StB 30.5 sockets) are required for fixing these in position. The clearance and creepage values required for the rated voltage of the terminal can change when accessories are fitted. This is especially true with cross-connections between neighbouring terminals with different potentials.

QB cross-connection comb

The QB can be inserted from above on the SAKT1/QT1 cross-connect/disconnect terminal. The connection or disconnection is then achieved by means of the integral disconnection slider.

QS 2 plug-in cross-connection

For 4 mm dia. sockets, for up to 44 A.

BS / VH

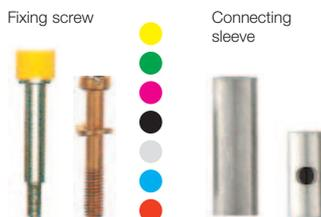

Type	Colour	Qty	Order No.
Fixing screws			
BS 25	yellow	50	0335700000
BS 25	green	50	0335600000
BS 25	violet	50	0335800000
BS 25	black	50	0335200000
BS 25	grey	50	0335300000
BS 25	blue	50	0335400000
BS 25	red	50	0335500000
BS 25	uninsulated	50	0334700000
BS M 3 x 20 CuNi 60 (copper alloy)		100	0377100000
Connecting sleeves			
VH 12 E-Cu 57 (copper alloy)		100	0249000000
VH 19 CuZn 39 (brass alloy)		50	0318000000

QL / Q

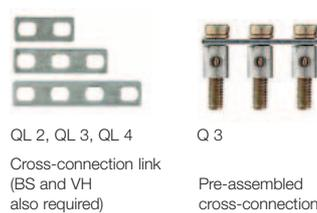

Type	No. of poles	Qty	Order No.
Cross-connection link (BS and VH also required)			
QL 2, QL 3, QL 4			
QL 2	2 poles	50	0194300000
QL 3	3 poles	50	0194400000
QL 4	4 poles	50	0194500000
QL 5	5 poles	50	0220500000
QL 6	6 poles	50	0220600000
QL 10	10 poles	20	0338300000
QL 15	15 poles	10	0221200000
Pre-assembled cross-connection			
E-Cu 57 (copper alloy)			
Q2	2 poles	50	0456700000
Q3	3 poles	50	0456800000
Q4	4 poles	50	0456900000
Q10	10 poles	20	0457000000

QB

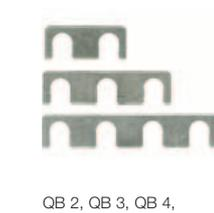

Type	No. of poles	Qty	Order No.
QB 2, QB 3, QB 4,			
QB 2	2 poles	50	0205700000
QB 3	3 poles	50	0205800000
QB 4	4 poles	50	0205900000
QB 10	10 poles	20	0343800000

QS 2

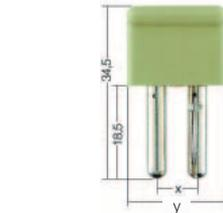

Type	No. of poles	Qty	Order No.
WQV			
QS 2	2 poles	20	0270960000
x = 8 mm, y = 16 mm			
QS 2	2 poles	20	0270860000
x = 10 mm, y = 20 mm			
QS 2	2 poles	20	0270760000
x = 12 mm, y = 20 mm			

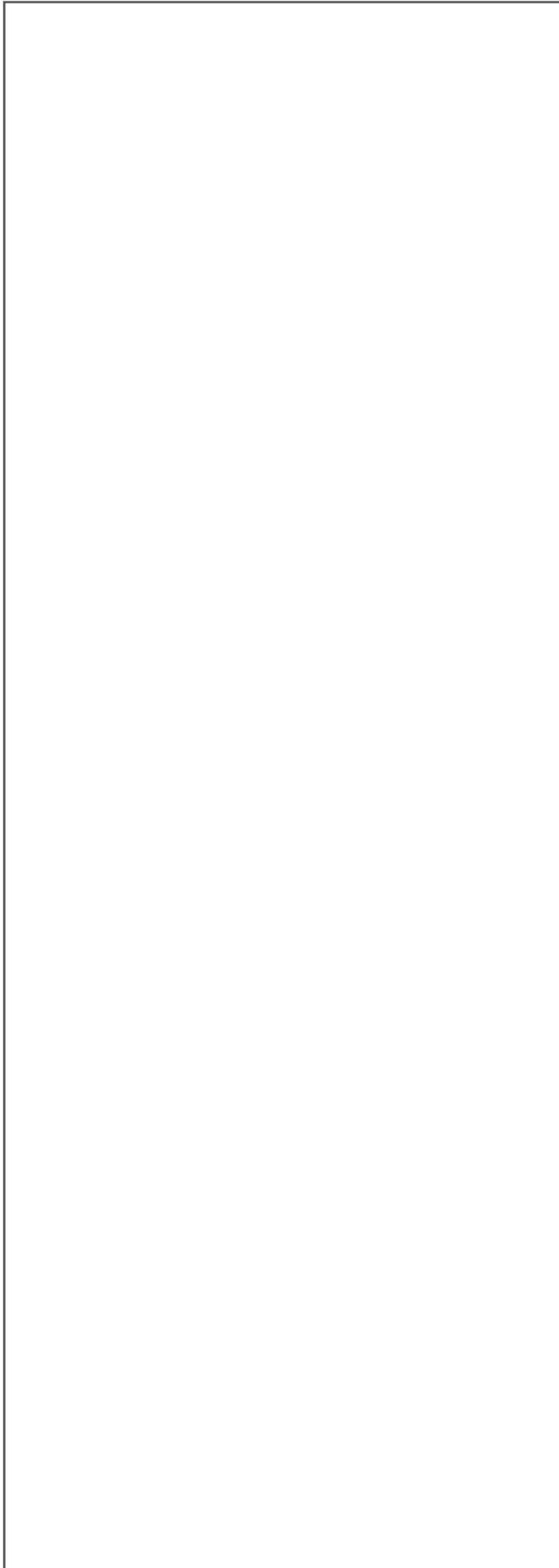

Tools	
Cutting tools	J.2
Cutting tools - Accessories	J.3
Stripping tools	J.4
Crimping tools	J.5 - J.6
Accessories	J.7 - J.12
Screwdrivers	J.13 - J.20
DMS manual / DMSI manual	J.21
Screwdrivers	J.22 - J.24

Cutting Tools

Cutting tools

- Cutting formation for different cable sizes increases the quality of the cuts for smaller cross-sections.

KT 8



Cutting tool that does not damage the conductor; for cutting copper and aluminium cables with a diameter of up to 8 mm

- Not suitable for steel wires, steel-armoured cables, aluminium alloys and hard-drawn copper conductors!

KT 12



Cutting tool that does not damage the conductor; for cutting copper and aluminium cables with a diameter of up to 12 mm

- Not suitable for steel wires, steel-armoured cables, aluminium alloys and hard-drawn copper conductors!

Technical data

Max. cutting performance copper cable	
Solid (max. conductor cross-section)	mm ² / AWG
Stranded (max. conductor cross-section)	mm ² / AWG
Flexible (max. conductor cross-section)	mm ² / AWG
Flexible, Stranded (max. diameter)	mm
Sector line	
Max. cutting performance aluminium cable	
Stranded (max. conductor cross-section)	mm ² / AWG
Stranded (max. diameter)	mm
Solid	mm ²
Data-/ telephone-/ control cable	
O.D. max.	mm
Tool data	
Length / width / height	mm
Weight	g
Information	
(tool closed)	

KT8		
		16 / 6
		16 / 6
		16 / 6
		8
		16 / 6
		8
		16
		8
		165 / 65 / 25
		180
		(tool closed)

KT12		
		16 / 6
		25 / 3
		35 / 2
		12
		25 / 6
		8
		25
		12
		215 / 66 / 28
		300
		(tool closed)

Order data

Version
Information

Type	Qty.	Order No.
KT 8	1	9002650000
Information		

Type	Qty.	Order No.
KT 12	1	9002660000
Information		

Accessories

Type	Qty.	Order No.
Information		

Type	Qty.	Order No.
Information		

Type	Qty.	Order No.
Information		

Stripping tools

Stripping- and cutting tools

- For flexible and massive conductors with PVC-insulation
- Stripping length adjustable with shoulder
- automatic opening of the clamping jaws after stripping
- no splicing of the single conductor
- adjustable to different insulation thickness
- cable with double insulation in two processing steps without special adjustment
- Blade-device free from float and self-adjustable
- long durability
- optimised ergonomically design

Stripax® 16



Stripax®



Stripping and cutting tool for flexible and massive conductors with PVC-insulation of 6...16 mm² (~AWG 10... 6)

- Cutting of flexible and massive conductors up to 6 mm² (AWG 10)
- No damaging of the conductor due to special blade forms

Stripping and cutting tool for flexible conductors with PVC-insulation of 0.08...6mm² (~AWG 28...10)

- No damaging of the conductor due to special, self-adjustable stripping blades
- Processing of multi-conductors, with thin flat ribbon cables even multiple conductors in one operation

Technical data

Max. stripping performance copper cable	
Cable model	
Conductor cross-section	mm ²
Conductor diameter	mm
Max. stripping length	mm
Adjustable depth of cut	mm
Cutting performance	
Max. cutting performance	mm ²
Tool data	
Length	mm
Weight	g
Information	

Stripax® 16	
flexible & solid PVC conductors	
6 ... 16	
20	
6	
190	
155	
Information	

Stripax®	
flexible & solid PVC conductors	
0.08 ... 6	
20	
6	
190	
155	
Information	

Order data

Version
Information

Type	Qty.	Order No.
stripax® 16	1	9055610000
Information		

Type	Qty.	Order No.
stripax®	1	9005000000
Information		

Accessories

Information	

Type	Qty.	Order No.
Spare stripping blades	1	9054080000
Cleaning brush	5	9005450000
Information		

Type	Qty.	Order No.
Cleaning brush	5	9005450000
Spare stripping blades	1	9054030000
Information		

Crimping tools

Crimping tool for wire and ferrules

- Positive blocking guarantees good-quality crimping.
- Release option in case of incorrect operation

PZ 6/5

Crimping tool for wire end ferrules from 0.25...6mm²



Crimping tool for wire end ferrules (according to DIN 46228 T. 1 and 4) with and without plastic collar of 0.25...6 mm² (~ AWG 24...10) and twin wire end ferrules of 0.5...4.0mm²

- Crimp according to Euro-Norm EN 60947-1
- Five crimping stations corresponding to the conductor cross-section
- Approval according to VG 95211 (military designation VG 95 236 T 14 B 002)

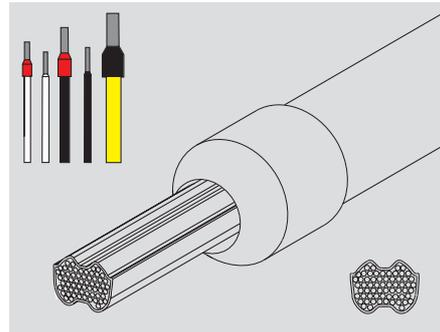

PZ 6roto

Crimping tool for wire end ferrules from 0.14...6mm²



Crimping tool for wire end ferrules of 0,14...6 mm² with and without plastic collar according to DIN 46228 T 1 and 4 (~ AWG 26...10) and twin-wire end ferrules of 0,5...4 mm²

- Only one die for the whole cross-section
- Pivoted die for wire end ferrule-insertion
- Wire end ferrule insertion from the front or from the side

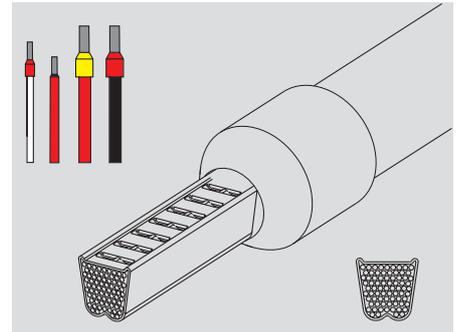

Technical data

Description of contact	
Type of contact	
Crimping range	mm ²
Crimping range 1 (with multiple crimping positions)	mm ²
Crimping range 2 (with multiple crimping positions)	mm ²
Crimping range 3 (with multiple crimping positions)	mm ²
Plug width	mm

PZ 6/5	
ferrules with/without plastic collar	
Crimping range	0.25 ... 6
Crimping range 1 (with multiple crimping positions)	0.25 ... 0.5
Crimping range 2 (with multiple crimping positions)	0.75 ... 1.5
Crimping range 3 (with multiple crimping positions)	2.5

PZ 6 roto	
ferrules with/without plastic collar	
Crimping range	0.14 ... 6

Tool data	
Length	mm
Weight	g

Length	mm	200
Weight	g	423

Length	mm	200
Weight	g	428

Order data

Version

Type	Qty.	Order No.
PZ 6/5	1	9011460000

Type	Qty.	Order No.
PZ 6 roto	1	9014350000

Accessories

Information

Information and ordering data for wire end ferrules see chapter tools wire end ferrules

Information and ordering data for wire end ferrules see chapter tools wire end ferrules

Crimpen

Crimping tool for wire and ferrules

- Positive blocking guarantees good-quality crimping
- Release option in case of incorrect operation
- Wire end ferrule insertion from the side

PZ 16

Crimping tool for wire end ferrules from 6...16mm²



Crimping tool for wire end ferrules (acc. to DIN 46228 part 1 and 4) with and without plastic collar from 6...16 mm² (~ AWG 10...6)

- Three crimping stations corresponding to the conductor cross-sections
- Crimp according to Euro-Norm EN 60947-1
- Approval according to VG 95211 (military designation VG 95 236 T 14 B 002)

PZ 50

Crimping tool for wire end ferrules with 25, 35 and 50mm²



Crimping tool for wire end ferrules of 25, 35 and 50 mm² with and without plastic collar acc. to DIN 46228 part 1 and 4 (~ AWG 3...1)

- Three crimping stations corresponding to the conductor cross-sections
- Crimp according to Euro-Norm EN 60947-1
- Approval according to VG 95211 (military designation VG 95 236 T 14 B 002)

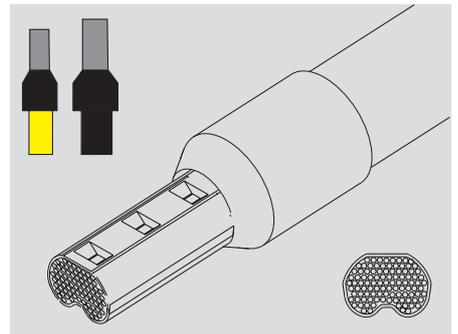
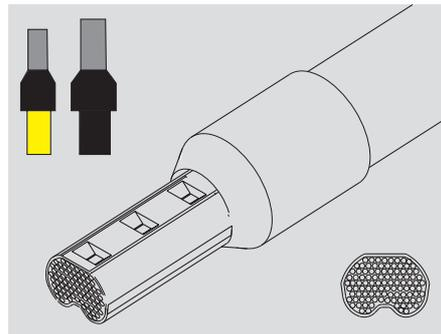

Technical data

Description of contact	
Type of contact	
Crimping range	mm ²
Crimping range 1 (with multiple crimping positions)	mm ²
Crimping range 2 (with multiple crimping positions)	mm ²
Crimping range 3 (with multiple crimping positions)	mm ²
Plug width	mm

PZ 16	
ferrules with/without plastic collar	
Crimping range	6 ... 16
Crimping range 1 (with multiple crimping positions)	6
Crimping range 2 (with multiple crimping positions)	10
Crimping range 3 (with multiple crimping positions)	16

PZ 50	
ferrules with/without plastic collar	
Crimping range	25 ... 50
Crimping range 1 (with multiple crimping positions)	25
Crimping range 2 (with multiple crimping positions)	35
Crimping range 3 (with multiple crimping positions)	50

Tool data	
Length	mm
Weight	g

Length	200
Weight	418

Length	260
Weight	700

Information

Information

Information

Order data

Version

Type	Qty.	Order No.
PZ 16	1	9012600000

Type	Qty.	Order No.
PZ 50	1	9006450000

Information

Information

Information

Accessories

Information

Information and ordering data for wire end ferrules see chapter tools wire end ferrules

Information and ordering data for wire end ferrules see chapter tools wire end ferrules

Accessories

Weidmüller stocks a comprehensive range of wire end ferrules and insulated cable lugs for immediate supply.

Wire end ferrules

Wire end ferrules ensure the long-term quality of electrical connections. Another advantage is their usefulness during installation. The wide range of products embraces wire end ferrules with or without plastic collars and twin wire end ferrules in all the colours normally required by users.



Insulated cable lugs

Insulated cable lugs ensure the long-term quality of electrical connections. Most of the products in the range (apart from the butt connectors) have a conical inlet. This guarantees optimum entry of the conductor as the strands are automatically centred.



Accessories

Tools

Tools for insulated cable lugs

Tool	Order No.	Type of contact		
		0,5 - 1,5	1,5 - 2,5	4,0 - 6,0
CTI 6	9006120000	●	●	
CTI 6 S	9006210000	●	●	
HTI 15	9014400000	●	●	●
Station		red	blue	yellow

Crimping tools for ferrules

	PZ 1.5	stripax® plus 2.5	PZ 3	PZ 4	PZ 6 roto	PZ 6 HEX	PZ 6/5	PZ 16	PZ 50
Order No.	9005990000	9020000000	0567300000	9012500000	9014350000	9013650000	9011460000	9012600000	9006450000
AEH mm²									
H 0.25	●				●	●	●		
H 0.34	●				●	●	●		
H 0.5	●	●	●	●	●	●	●		
H 0.75	●	●	●	●	●	●	●		
H 1.0	●	●	●	●	●	●	●		
H 1.5	●	●	●	●	●	●	●		
H 2.5		●	●	●	●	●	●		
H 4.0			●	●	●	●	●		
H 6.0			●		●	●	●	●	
H 10.0								●	
H 16.0								●	
H 25.0									●
H 35.0									●
H 50.0									●

● = ferrules in strip form only

Twin wire end ferrules are to be crimped according to the following table

Tool	Order No.	Ferrules								
		H 0,5	H 0,75	H 1,0	H 1,5	H 2,5	H 4,0	H 6,0	H 10,0	H 16,0
PZ 1.5	9005990000	●	●							
PZ 3	0567300000	●	●	●	●	●				
PZ 4	9012500000	●	●	●	●	●				
PZ6 roto	9014350000	●	●	●	●	●	●			
PZ 6/5	9011460000		●	●	●	●	●			
Station		1,5 mm²	1,5 mm²	2,5 mm²	2,5 mm²	4 mm²	6 mm²			
PZ ZH16	9013600000							●	●	●

Accessories

Wire end ferrules with plastic collars

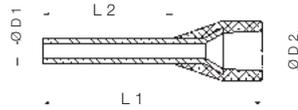

Nominal cross-section (mm ²)	AWG	Dimensions (mm)				Stripping length		Qty
		L 1	L 2	D 1	D 2	mm	mm	
0.14	26	10	6	0.6	1.5	8	500	
	26	12	8	0.6	1.5	10	500	
0.25	24	10	6	0.8	1.8	8	500	
	24	12	8	0.8	1.8	10	500	
0.34	22	10	6	0.8	2	8	500	
	22	12	8	0.8	2	10	500	
	22	12	8	0.8	2	10	5000	
0.5	20	10	6	1	2.6	8	500	
	20	12	6	1	2.6	8	500	
	20	14	8	1	2.6	10	500	
	20	14	8	1	2.6	10	5000	
	20	16	10	1	2.6	12	500	
0.75	18	12	6	1.2	2.8	8	500	
	18	14	8	1.2	2.8	10	500	
	18	14	8	1.2	2.8	10	5000	
	18	16	10	1.2	2.8	12	500	
	18	18	12	1.2	2.8	14	500	
1	17	12	6	1.4	3	8	500	
	17	14	8	1.4	3	10	500	
	17	14	8	1.4	3	11	5000	
	17	16	10	1.4	3	12	500	
	17	18	12	1.4	3	15	500	
1.5	16	14	8	1.7	3.5	10	500	
	16	14	8	1.7	3.2	10	5000	
	16	14	8	1.7	3.2	10	500	
	16	16	10	1.7	3.5	12	500	
	16	18	12	1.7	3.5	15	500	
2.5	14	14	8	2.2	4.2	10	500	
	14	14	8	2.2	4	11	3000	
	14	14	8	2.2	4	11	500	
	14	18	12	2.2	4.2	14	500	
	14	24	18	2.2	4.2	20	500	
4	12	17	10	2.8	4.8	12	500	
	12	20	12	2.8	4.8	14	500	
	12	26	18	2.8	4.8	20	500	
6	10	20	12	3.5	6.3	14	100	
	10	26	18	3.5	6.3	20	100	
10	7	22	12	4.5	7.6	15	100	
	7	28	18	4.5	7.6	21	100	
16	6	24	12	5.8	8.8	15	100	
	6	28	18	5.8	8.8	21	100	
25	3	30	16	7.3	11.2	18	50	
	3	36	22	7.3	11.2	24	50	
35	2	30	16	8.3	12.7	19	50	
	2	30	18	8.3	12.7	21	50	
	2	39	25	8.3	12.7	28	50	
50 ...	1	36	20	10.3	15	26	50	
	1	40	25	10.3	15	31	50	
	2/0	37	20	12.7	16	26	25	
	3/0	44	25	14.7	18	31	25	
	4/0	50	30	16.5	21	36	25	
150	300 MCM	54	32	18.5	23.5	38	25	

Weidmüller standard

Type	Colour	Order No.	Strip pack Order No.	Ferrules in strip form Order No.	Ferrules on reels Order No.
H 0.14/10	grey		9005180000		
H 0.14/12	grey		9028240000		
H 0.25/10	light blue	9025740000	9026050000		
H 0.25/12	light blue	9025760000	9025780000		
H 0.34/10	turquoise	9025750000	9026030000		
H 0.34/12	turquoise	9025770000	9025790000		
H 0.34/12	turquoise				9004390000
H 0.5/10	orange		9028260000		
H 0.5/12	orange	0409500000			
H 0.5/14	orange	0690700000	9026060000	9004270000	
H 0.5/14	orange				9005810000
H 0.5/16	orange	9025870000	9028270000		
H 0.75/12	white	0409600000	9028280000		
H 0.75/14	white	0462900000	9026070000	9004290000	
H 0.75/14	white				9005820000
H 0.75/16	white	9025860000	9028290000		
H 0.75/18	white	9025910000	9028300000		
H 1/12	yellow	0409700000	9028310000		
H 1/14	yellow	0463000000	9026080000	9004320000	
H 1/14	yellow				9005830000
H 1/16	yellow	9025950000	9028320000		
H 1/18	yellow	9025930000	9028340000		
H 1.5/14	red	0463100000	9026090000		
H 1.5/14	red				9005840000
H 1.5/14	red			9004340000	
H 1.5/16	red	0635100000	9028350000		
H 1.5/24	red	0565600000			
H 2.5/14 D	blue	9019160000	9026100000		
H 2.5/14 D	blue			9004360000	9005850000
H 2.5/14 D	blue				
H 2.5/18 D	blue	9019170000			
H 2.5/24 D	blue	9019180000			
H 4/17 D	grey	9019190000	9026010000*		
H 4/20 D	grey	9019200000			
H 4/26 D	grey	9019210000			
H 6/20	black	0533500000			
H 6/26	black	0565700000			
H 10/22	ivory	0534200000			
H 10/28	ivory	0565800000			
H 16/24	green	0565900000			
H 16/28	green	0566000000			
H 25/30	brown	0317000000			
H 25/36	brown	0317100000			
H 35/30	beige	0317200000			
H 35/39	beige	0317300000			
H 50/36	olive	0444200000			
H 70/40	yellow	9028200000			
H 95/44	red	9028210000			
H 120/50	blue	9028220000			
H 150/54	yellow	9028230000			

Standard 5x 100 ferrules

* Strip pack 5x 50 ferrules

Accessories

Twin wire end ferrules with plastic collar

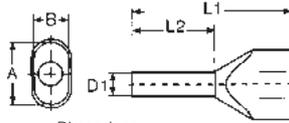

	Nominal cross-section (mm ²)	AWG	Dimensions (mm)				Stripping length (mm)	Qty
			L 1	L 2	D 1	A/B		
0.5	0.5	20	15	8	1.4	5/3	11	500
	0.5	20	16	10	1.4	5/3	13	500
	0.5	20	19	12	1.4	5/3	15	500
0.75	0.75	18	15	8	1.7	5.5/3	11	500
	0.75	18	17	10	1.7	5.5/3	13	500
	0.75	18	24	18	1.7	5.5/3	21	500
1	1.0	17	16	8	2.2	6.5/3.6	12	500
	1.0	17	15	8	2.0	5.8/3.2	12	500
	1.0	17	19	12	2.0	5.8/3.2	16	500
	1.0	17	25	18	2.0	5.8/3.2	22	500
1.5	1.5	16	16	8	2.2	6.5/3.6	11	500
	1.5	16	20	12	2.2	6.5/3.6	15	500
	1.5	16	26	18	2.2	6.5/3.6	21	100
2.5	2.5	14	19	10	2.8	8/4.5	13	500
	2.5	14	19	10	2.8	8/4.5	13	250
	2.5	14	21	12	2.8	8/4.5	15	500
	2.5	14	21	12	2.8	8/4.5	15	250
	2.5	14	27	18	2.8	8/4.5	21	500
4	4.0	12	22	12	3.5	9/5.2	15	100
	4.0	12	28	18	3.5	9/5.2	21	100
6	6.0	10	25	12	4.5	11.4/6.2	20	100
	6.0	10	29	18	4.5	11.4/6.2	24	100
10	10.0	7	24	12	5.8	13.4/7.6	17	100
	10.0	7	30	18	5.8	13.4/7.6	23	100
	10.0	7	24	12	6.5	13.4/7.6	17	100
	10.0	7	30	18	6.5	13.4/7.6	23	100
16	16.0	6	29	16	8.3	17.2/9.5	20	50
	16.0	6	38	25	8.3	17.2/9.5	29	50

Weidmüller standard



Type	Colour	Order No.	Strip pack Order No.
H 0.5/15	orange	9037200000	9004440000*
H 0.5/16.5	orange	9037210000	
H 0.5/18.5	orange	9037220000	
H 0.75/15	white	9037230000	9018510000***
H 0.75/17	white	9037240000	9004900000*
H 0.75/24.5	white	9037250000	
H 1/15S	yellow	9018690000	9018650000*
H 1/15	yellow	9037260000	9018530000*
H 1/20	yellow	9037270000	9004910000*
H 1/25.6	yellow	9037280000	
H 1.5/16	red	9037290000	9004410000*
H 1.5/20	red	9037300000	9004920000*
H 1.5/25.6	red	9037310000	
H 2.5/18.5D	blue	9037500000	
H 2.5/18.5D	blue		9004430000**
H 2.5/20.5D	blue	9037510000	
H 2.5/20.5D	blue		9004740000**
H 2.5/26.5D	blue	9037520000	
H 4/22D	grey	9037530000	9004730000***
H 4/28D	grey	9037540000	
H 6/25	black	9037320000	9004930000***
H 6/29	black	9037330000	
H 10/26	ivory	9037340000	9004940000***
H 10/30	ivory	9037350000	
H 10/24 S	ivory	9018860000	
H 10/30 S	ivory	9018870000	
H 16/29	green	9037360000	
H 16/38	green	9037370000	

* 5 x 100 ** 5 x 50 *** 5 x 20

Wire end ferrules for short-circuit-proof and earthing-proof conductors

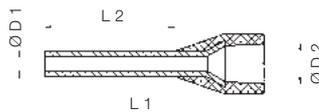

	Nominal cross-section (mm ²)	AWG	Dimensions (mm)				Stripping length (mm)	Qty
			L 1	L 2	D 1	D 2		
1,5	1.5	16	17.5	8	1.8	6.8	13	100
	1.5	16	19.5	10	1.8	6.8	15	100
2,5	2.5	14	17.5	8	2.3	7.6	14	100
	2.5	14	21.5	12	2.3	7.6	17	100
4	4	12	19.5	10	2.9	7.8	14	100
6	6	10	23	12	3.6	8.1	17	100
10	10	7	24	12	4.6	9.6	17	100
16	16	6	25.5	12	6	11.9	26	100

Type	Colour	Order No.	Strip pack Order No.
H 1.5/17.5XS	black		9006590000
H 1.5/19.5XS	black		9006630000
H 2.5/17.5XS	blue		9006670000
H 2.5/21.5XS	blue		9006710000
H 4/19.5XS	grey		9006750000
H 6/23XS	yellow		9006790000
H 10/24.5XS	red		9006830000
H 16/25.5XS	blue		9006870000

Accessories

DIN

Type	Colour	Order No.	Strip pack Order No.
H 0.5/15D	● white	9037380000	9004780000*
H 0.5/16.5D	● white	9037390000	
H 0.5/18.4D	● white	9037400000	
H 0.75/15D	● grey	9037410000	9018520000*
H 0.75/17D	● grey	9037420000	9004770000*
H 0.75/24.5D	● grey	9037430000	
H 1/15D	● red	9037440000	9018540000*
H 1/20D	● red	9037450000	9004760000*
H 1/25.6D	● red	9037460000	
H 1.5/16D	● black	9037470000	9004420000*
H 1.5/20D	● black	9037480000	9004750000*
H 1.5/25.6D	● black	9037490000	
H 2.5/18.5D	● blue	9037500000	
H 2.5/18.5D	● blue		9004430000**
H 2.5/20.5D	● blue	9037510000	
H 2.5/20.5D	● blue		9004740000**
H 2.5/26.5D	● blue	9037520000	
H 4/22D	● grey	9037530000	9004730000***
H 4/28D	● grey	9037540000	
H 6/25D	● yellow	9037550000	9004720000***
H 6/29D	● yellow	9037560000	
H 10/26D	● red	9037570000	9004710000***
H 10/30D	● red	9037580000	
H 10/24 DS	● red	9018880000	
H 10/30 DS	● red	9018890000	
H 16/29D	● blue	9037590000	
H 16/38D	● blue	9037600000	

Others

Type	Colour	Order No.	Strip pack Order No.
H 0.5/15	● orange	9037200000	
H 0.5/16.5	● orange	9037210000	
H 0.5/18.5	● orange	9037220000	
H 0.75/15T	● light blue	9037610000	9018570000*
H 0.75/17T	● light blue	9037620000	9005140000*
H 0.75/24.5T	● light blue	9037630000	
H 1/15D	● red	9037440000	9018540000*
H 1/20D	● red	9037450000	9004760000*
H 1/25.6D	● red	9037460000	
H 1.5/16D	● black	9037470000	9004420000*
H 1.5/20D	● black	9037480000	9004750000*
H 1.5/25.6D	● black	9037490000	
H 2.5/18.5T	● grey	9037640000	
H 2.5/18.5T	● grey		9018580000**
H 2.5/20.5T	● grey	9037650000	
H 2.5/20.5T	● grey		9005150000**
H 2.5/26.5T	● grey	9037660000	
H 4/22T	● orange	9037670000	9018590000***
H 4/28T	● orange	9037680000	
H 6/25T	● green	9037690000	9005160000***
H 6/29T	● green	9037700000	
H 10/26T	● brown	9037710000	9005170000***
H 10/30T	● brown	9037720000	
H 16/29T	● white	9037730000	
H 16/38T	● white	9037740000	

* 5 x 100 ** 5 x 50 *** 5 x 20

J

Wire end ferrules with plastic collars Special sizes

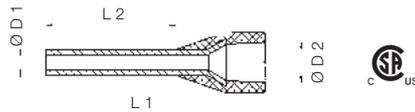

	Nominal cross-section (mm ²)	AWG	Dimensions (mm)				Stripping length (mm)	Qty	Type	Colour	Order No.	Strip pack Order No.
			L 1	L 2	D 1	D 2						
	0.5	20	14	8	1	2.9	10	500	H 0.5/14 S	● orange	9004560000	
	0.5	20	14	8	1	2.9	10	500	H 0.5/14 DS	● white	9004590000	
	0.75	18	14	8	1.2	3.4	10	500	H 0.75/14 S	● white	9025960000	9025700000*
	0.75	18	14	8	1.2	3.4	10	500	H 0.75/14 TS	● light blue	9018550000	
	1	17	14	8	1.4	3.5	10	500	H 1/14 S	● yellow	9025970000	9025710000*
	1	17	14	8	1.4	3.5	10	500	H 1/14 DS	● red	9018560000	
	1.5	16	12	6	1.7	3.5	8	500	H 1.5/12 S	● red	9025690000	
	1.5	16	14	8	1.7	3.9	10	500	H 1.5/14 S	● red	9025980000	9025720000*
	1.5	16	14	8	1.7	3.9	10	500	H 1.5/14 DS	● black	9025240000	9028360000*
	2.5	14	12	6	2.2	4.2	8	500	H 2.5/12 DS	● blue	9028490000	
	2.5	14	14	8	2.2	4	10	500	H 2.5/14 DS	● blue	1333100000	
	2.5	14	16	10	2.2	4.2	13	500	H 2.5/16 DS	● blue	9036220000	
	2.5	12	12	6	2.2	4.2	8	500	H 2.5/12 TS	● grey	9036200000	
	2.5	14	14	8	2.2	4.2	10	500	H 2.5/14 TS	● grey	9426770000	
	2.5	14	16	10	2.2	4.2	13	500	H 2.5/16 TS	● grey	9036210000	
	4.0	12	14	8	2.8	4.8	10	500	H 4.0/14 DS	● grey	9028520000	
	4.0	12	15	8	2.8	4.8	12	500	H 4.0/15 TS	● orange	9036230000	

* 5 x 100 ferrules

Screwdrivers

Rechargeable torque screwdriver

DMS 3



DMS 3 Set



DMS 3 rechargeable torque screwdriver

- One-hand operation under all working conditions
- Switchable forward and reverse
- Two speeds: 200 and 400 rpm
- Precise torque settings from approx. 0.2 ... 3 Nm in 6 steps
- Consistent performance during battery discharge
- Grip swings easily from rod to pistol form
- Takes 1/4" bits held by ball-bearing clamping mechanism (form E6.3)
- Safety lock prevents inadvertent switch-on
- Easy changeover from battery drive to manual operation up to 15 Nm

- inclusive bits for slotted screw
Dimension of the blade:
0,5 x 3,0; 0,6 x 3,5; 0,8 x 4,0; 1,0 x 5,5
(Length: 70 mm)

Technical data

Screwdriver	
Motor	2.4 V DC
Idling speed	200/400 rpm
Max. torque	3.0 Nm
Chuck	1/4" C6.3 DIN 3126
Length	239 mm
Weight	400 g
Battery	
Type	2 Ni-Cd batteries each 1.2 V
Weight	122 g
Charger	
Input	230 V AC, 50 Hz, 50 mA
Output	2.9 V AC, 1.4 A, 4.1 VA
Charging time	1 hour
Weight	700 g

Ordering data

Type	Qty	Order No.
DMS 3	1	9007440000
Screwdriver incl. battery		

Type	Qty	Order No.
DMS 3 set 1 (screwdriver incl. battery, 1 charger, bits, plastic carrying case)	1	9007470000
DMS 3 set 2 (as set1 with 1 additional battery)	1	9007480000

*) see figure

Accessories

Type	Qty	Order No.
Spare battery	1	9007450000
Charger	1	9007460000

Screwdrivers

Overview

Weidmüller screwdrivers come in four different grip sizes, and are the result of a consistent grip concept which takes into account both the human hand and the different requirements when working

- Perfect handling with all grip sizes
- Maximum torques
- Optimum transmission of axial force
- Complete range including all commercial dimensions



SoftFinish-grip

With the SoftFinish zone for use in dry conditions and for general applications, Weidmüller offers a complete range of screwdrivers that enables far higher torques and at the same time substantially more comfort due to the soft material of the grip.

Product benefits:

- Made of special soft material which is kind to the skin, the SoftFinish zone enables maximum torques
- Perfect ergonomic grip design for comfortable screw driving and optimum handling
- Version with solid steel tip can be used for chiselling
- You can choose from long-life extremely stressable blades in standard sizes
- ChromTop blade tip offers maximum corrosion protection and greatest possible dimensional accuracy of the blade geometry in the screw head over many years

SoftFinish electric

VDE-insulated screwdriver according to DIN EN 60900, IEC 900 for work on live equipment

Product benefits:

- The protective insulation directly injected onto the screwdriver blade ensures electrical safety, even in critical applications
- Safe for working at up to 1500 volts DC and 1000 volts AC
- Each screwdriver is individually tested in a water bath at 10,000 volts according to DIN EN 60900
- Perfect ergonomic grip design for comfortable screw driving and optimum handling
- Made of special soft material which is kind to the skin, the SoftFinish zone prevents slipping in critical situations and at the same time enables maximum torques

Screwdrivers

Combined cutting and screw driving tool

that does not damage the edge; for cutting of copper cables with a diameter of up to 1.5 mm² solid and 2.5 mm² flexible.

swifty®



swifty®

- Cable cutting tool to mount on non-insulated screw drivers with a blade diameter of 3.5 mm
- Minimum manual force required
- Automatic opening of the cutter
- Ergonomically designed grip

swifty®set

- Efficient operation:
- Only one tool for cable-processing in IDC-technology
- Suitable for screw and tension clamps
- Readily available pocket size
- For right-handed and left-handed use
- One-hand operation

swifty®set



Technical data

Maximum cutting performance		
Copper cable:		
Solid cable (conductor cross-section)	mm ²	1.5
Flexible cable (conductor cross-section)	mm ²	2.5
Tool data		
Length/width/height	mm	35 / 18 / 40
Weight	g	20

Ordering data

Type	Qty	Order No.
swifty® (without screwdriver)	1	9006020000

Type	Qty	Order No.
swifty®set (with screwdriver)	1	9006060000
Screwdriver (SD 0.6x3.5x100)	1	9008330000

Screwdrivers

VDE insulated Screwdriver

VDE-insulated screwdriver sets, for working on live parts up to 1000 V AC and 1500 V DC. DIN EN 60900, IEC 900. safety tested GS, checked individually. Blade made from high-alloy chromium-vanadium-molybdenum steel, through-hardened, browned

SDI S

VDE-insulated slot-head screwdriver, SDI DIN 7437, ISO 2380/2, output acc. to DIN 5264, ISO 2380/1, SoftFinish-grip



SDIK PH

VDE-insulated crosshead screwdriver type Phillips, SDIK PH DIN 7438, ISO 8764/2-PH, output acc. to DIN 5260-PH, ISO 8764/1-PH, SoftFinish-grip



SDIK PZ

VDE-insulated crosshead screwdriver type Pozidriv SDIK PZ DIN 7438, ISO 8764/2-PZ, output acc. to DIN 5260-PZ, ISO 8764/1-PZ, SoftFinish-grip



SDIT

VDE-insulated Torx®-screwdriver, SDIT SoftFinish-grip



SKI

VDE-insulated hexagon socket wrench, SKI SoftFinishh-grip



Hinweis

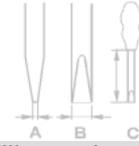

Typ	Größe / SW	A	B	C	Best.-Nr.
SDI 0,4x2,5x75		0,4	2,5	80	9008370000
SDI 0,5x3,0x100		0,5	3	100	9008380000
SDI 0,6x3,5x100		0,6	3,5	100	9008390000
SDI 0,8x4,0x100		0,8	4	100	9008400000
SDI 1,0x4,5x125		1	4,5	125	9008910000
SDI 1,0x5,5x125		1	5,5	125	9008410000
SDI 1,2x6,5x150		1,2	6,5	150	9008420000
SDI 1,6x8,0x175		1,6	8	200	9008430000
SDI-SATZ3/3,5/4					9008440000

SDIK PH0	0	60	9008560000
SDIK PH3	3	150	9008590000
SDIK PH1	1	80	9008570000
SDIK PH2	2	100	9008580000
SDIK SATZ 1+2			9008600000

SDIK PZubehör Nummer	1	80	9008900000
SDIK PZ2	2	100	9008890000

SDIT 10	10	80	9009640000
SDIT 15	15	80	9009650000
SDIT 20	20	80	9009660000
SDIT 25	25	80	9009670000
SDIT 30	30	100	9009680000
SDIT 40	40	150	9009690000
SDIT 8	8	60	9201940000

SKI 5,0x129	5	125	9009000000
SKI 5,5x128	5,5	125	9008990000
SKI 6,0x128	6	125	9008980000
SKI 7,0x127	7	125	9008970000
SKI 8,0x127	8	125	9008960000
SKI 9,0x126	9	125	9008950000
SKI 10,0x126	10	125	9008940000
SKI 11,0x125	11	125	9008930000
SKI 13,0x125	13	125	9008920000

Screwdrivers

VDE insulated Screwdriver

VDE-insulated screwdriver sets Weidmüller SoftFinish electric for working on live parts up to 1000 V AC and 1500 V DC. DIN EN 60900, IEC 900. safety tested GS, individually Checked

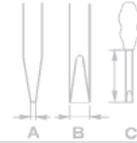

SDIS 2,5-5,5/PH/1/2

6-part set: VDE-insulated slot-head and cross-head PH Screwdriver set



Type	Size / SW	A	B	C	Order No.
SDI 0,4x2,5x75		0.4	2.5	80	
SDI 0,5x3,0x100		0.5	3	100	
SDI 0,8x4,0x100		0.8	4	100	
SDI 1,0x5,5x125		1	5.5	125	
SDI PH 1				80	
SDI PH 2				100	
SDIS 2,5-5,5/PH1/2					9009730000

SDI T8-30

6 part set: VDE-insulated TORX® screwdriver set



SDIT 8				60	
SDIT 10				80	
SDIT 15				80	
SDIT 20				80	
SDIT 25				80	
				100	
SDIS T8-30					9201950000

Hinweis

Screwdrivers

Uninsulated screwdriver

Weidmüller SoftFinish screwdriver for general uses, blade made from high-alloy chromium-vanadium-molybdenum steel, through-hardened, matt chrome finish.

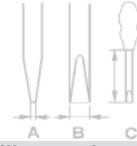

SD S

Slot-head screwdriver with circular blade SD DIN 5265, ISO 2380/2, output acc. to DIN 5264, ISO 2380/1, point chromium top, SoftFinish-grip



Typ	Größe / SW	A	B	C	Best.-Nr.
SD 0,4x2,0x60		0,4	2	60	9037160000
SD 0,4x2,5x75		0,4	2,5	75	9009030000
SD 0,5x3,0x80		0,5	3	80	9008320000
SD 0,6x3,5x100		0,6	3,5	100	9008330000
SD 0,6x3,5x200		0,6	3,5	200	9010110000
SD 0,8x4,0x100		0,8	4	100	9008340000
SD 0,8x4,5x125		0,8	4,5	125	9009020000
SD 1,0x5,5x150		1	5,5	125	9008350000
SD 1,2x6,5x150		1,2	6,5	150	9009010000

SDK PH

Crosshead screwdriver Type Phillips, SDK PH DIN 5262, ISO 8764/2-PH, output acc. to DIN 5260-PH, ISO 8764/1-PH, point chromium top, SoftFinish-grip



SDK PH0	0			60	9008470000
SDK PH1	1			80	9008480000
SDK PH2	2			100	9008490000
SDK PH3	3			150	9008500000

SDK PZ

Crosshead screwdriver Type Pozidriv, SDK PZ DIN 5262, ISO 8764/2-PZ, output acc. to DIN 5260-PZ, ISO 8764/1-PZ, point chromium top, SoftFinish-grip



SDK PZ0	0			60	9008520000
SDK PZubehör Nummer	1			80	9008530000
SDK PZ2	2			100	9008540000
SDK PZ3	3			150	9008550000

SDTR

Torx® TR-screw driver with drill hole in the blade point (Tamper Resistant), SD TR for screwing of Torx® and Torx®-TR safety screws (centre pin in profile), point chromium top, SoftFinish-grip



SDTR 8	8			60	9009190000
SDTR 10	10			80	9009180000
SDTR 15	15			80	9009170000
SDTR 20	20			100	9009160000
SDTR 25	25			100	9009150000
SDTR 30	30			115	9009140000

SK

Hexagon socket wrench SK DIN 3125, output acc. to DIN 3125, SoftFinish-grip



SK 5,0x125	5			125	9009130000
SK 5,5x125	5,5			125	9009120000
SK 6,0x125	6			125	9009110000
SK 7,0x125	7			125	9009100000
SK 8,0x125	8			125	9009090000
SK 9,0x125	9			125	9009080000
SK 10,0x125	10			125	9009070000
SK 11,0x125	11			125	9009060000
SK 12,0x125	12			125	9009050000
SK 13,0x125	13			125	9009040000

Hinweis

Screwdrivers

Uninsulated screwdriver

Set of interchangeable blades made from high-alloy chromium-vanadium-molybdenum steel, through-hardened, high-quality galvanised finish.

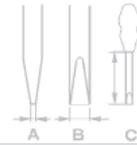

System 11+1 S-PH-PZ-SK

12-part set of interchangeable blades for slot-head, cross-head PH/PZ and hexagon screws, SoftFinish-grip



Typ	Größe / SW	A	B	C	Best.-Nr.
SD		0.5	3	140	
SD		0.8	4	140	
SD		1	5	140	
SD		1.2	6	140	
PH 1	1			140	
PH 2	2			140	
PZ 1	1			140	
PZ 2	2			140	
SK	3		3	140	
SK	4		4	140	
SK	5		5	140	
System 11+1					9009750000

System 11+1 TW-TS-TR

12-part set of interchangeable blades for screwing of Torx®, Torq® and Tri-Wing® safety screws.



TR	10			140	
TR	15			140	
TR	20			140	
TR	25			140	
TR	30			140	
TS	6			140	
TS	8			140	
TW	1			140	
TW	2			140	
TW	3			140	
TW	4			140	
System 11+1 Secur.					9009760000

Set S 2.5/3.0/4.0/5.5/PH 1/2

12-part set of interchangeable blades for slot-head, cross-head PH screwdriver set with circular blades



SD 0,4x2,5x75		0.4	2.5	75	
SD 0,5x3,0x80		0.5	3	80	
SD 0,8x4,0x100		0.8	4	100	
SD 1,5x5,5x125		1	5.5	125	
SD PH 1	1			80	
SD PH 2	2			100	
SDS 2,5-5,5/PH1/2					9009740000

Set TR 10/15/20/25/30/40

6-part set: Torx® screw driver with drill hole in the blade point



SD TR 30	8			60	
SD TR 10	10			80	
SD TR 15	15			80	
SD TR 20	20			100	
SD TR 25	25			100	
SD TR 30	30			150	
SDS TR8-30					9009720000

SD STK

Flat blade screwdriver with solid steel cap SD STK DIN 5265, ISO 2380/2, output acc. to DIN 5264, ISO 2380/1, can also be used as a chisel due to steel cap SoftFinish-grip



SD STK 10x175		1.6	10	175	9009710000
SD STK 8x150		1.2	8	150	9009700000

Hinweis

Screwdrivers

Wrench set Weidmüller

Allen key in PocketStar

Allen key made from high-alloy chromium-vanadium- steel, acc. to DIN ISO 2936 L (DIN 911), surface high-quality refined.

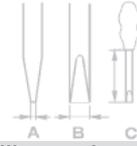

SK WSD S

9-part offset screwdriver set in Prostar, with MagicRing: holds standard screws in any position thanks to spring steel ring (beginning with size 3), with spherical head: for angled screwing up to 25°.



Typ	Größe / SW	A	B	C	Best.-Nr.
	1,5				
	10				
	2				
	2,5				
	3				
	4				
	5				
	6				
	8				
SK WSD-S 1,5-10,0					9008850000

SK S

7-part allen key set



	2				
	2,5				
	3				
	4				
	5				
	6				
	8				
SK-S 2,0-8,0					9008860000

SK S

7-part allen key set with MagicRing and spherical head: holds standard screws in any position thanks to spring steel ring (beginning with size 3), with spherical head: for angled screwing up to 25°.



	2				
	2,5				
	3				
	4				
	5				
	6				
	8				
SK-S 2,0-8,0 MR					9008870000

TR S

8-part Torx® TR-screw driver set

with drill hole in the blade point (Tamper Resistant), for screwing of Torx® and Torx®-TR safety screws (centre pin in profile)



	10				
	15				
	20				
	25				
	27				
	30				
	40				
	9				
TR-S 9-40					9008880000

Hinweis

DMS manual / DMSI manual

Torque screwdrivers with insulation up to 1000V (VDE)

• DMSI manual

The “DMSI manual” with integral window scale combined with a Weidmüller 1000V insulated (VDE) interchangeable blade ensures controlled tightening of screws plus reliability in electrical applications.

Every 1000V insulated handle (VDE) and blade (VDE) is tested and provides the necessary safety up to 1000 V AC/1500 V DC.



VDE GS 1000 V
EN 60900

Scale

Torque screwdrivers

• DMS manual

This is a versatile tool suitable for a variety of jobs, with integral scale for easy reading of the torque value plus a Weidmüller interchangeable blade.



Each model is available with two torque ranges:

- 0.5 to 1.7 Nm
- 2.0 to 8.0 Nm
- setting tool included



Setting tool

Advantages

- Compact and especially lightweight design
- Torque set with special tool (included) to ensure the right setting
- Ergonomic handle size to match the torque range
- Every tool checked and given an ID no., 100% quality control with verification and product reference
- Audible, unmistakable click upon reaching the torque, no unnecessary effort
- Interchangeable blade made from high-quality wear-resistant tool steel
- All tools comply with the accuracy stipulations of: EN ISO 6798, BS EN 26789, ASME B107.14M
- Operating accuracy: $\pm 6\%$ of set scale value

Screwdrivers

Screwdriver

Torque-screwdriver Weidmüller SoftFinish

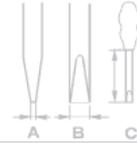

DMS manual

Torque-screwdriver
EN ISO 6798, BS EN 26789, ASME B107.14M



Type	Size / SW	A	B	C	Order No.
DMS manuell 2,0-8,0	2.0 - 8.0 Nm				9918380000
DMS manuell 0,5-1,7	0.5 - 1.7 Nm				9918370000

WK K PZ

Interchangeable blades for torque-screwdriver
output according to DIN 5260-PZ, ISO 8764/1-PZ



WK K PZ 0	max. 0.9 Nm			175	9918600000
WK K PZ 1	max. 3.8 Nm			175	9918610000
WK K PZ 2	max. 5.5 Nm			175	9918620000

WK K PH

Interchangeable blades for torque-screwdriver
output according to DIN 5260-PH, ISO 8764/1-PH



WK K PH 0	max. 0.9 Nm			175	9918570000
WK K PH 1	max. 3.8 Nm			175	9918580000
WK K PH 2	max. 5.5 Nm			175	9918590000

WK K S

Interchangeable blades for torque-screwdriver
output according to DIN 5264, ISO 2380/1



WK S 0,4 x 2,5	max. 0.6 Nm	0.4	2.5	175	9918520000
WK S 0,5 x 3,0	max. 0.6 Nm	0.5	3	175	9918530000
WK S 0,6 x 3,5	max. 1.1 Nm	0.6	3.5	175	9918540000
WK S 0,8 x 4,0	max. 2.5 Nm	0.8	4	175	9918550000
WK S 1,0 x 5,5	max. 3.8 Nm	1	5.5	175	9918560000

Hinweis

Adjusting tool is included in the scope of supply of the DMS manual

Screwdriver

Screwdriver

VDE insulated torque screwdriver Weidmüller SoftFinish electric for work on live parts up to 1000 Vac and 1500 Vdc.
DIN EN 60900, IEC 900, GS symbol, every one tested.



DMSI manual

VDE-insulated torque-screwdriver
EN ISO 6798, BS EN 26789, ASME B107.14M



Type	Size / SW	A	B	C	Order No.
DMSI manuell 0,5-1,7	0,5 - 1,7 Nm				9918390000
DMSI manuell 2,0-8,0	2,0 - 8,0 Nm				9918400000

WK SI

VDE-insulated interchangeable blades for VDE-insulated torque-screwdriver
output according to DIN 5264, ISO 2380/1



WK SI 0,4 x 2,5	max. 0.6 Nm	0,4	2,5	175	9918410000
WK SI 0,5 x 3,0	max. 0.6 Nm	0,5	3	175	9918420000
WK SI 0,6 x 3,5	max. 1.1 Nm	0,6	3,5	175	9918430000
WK SI 0,8 x 4,0	max. 2.5 Nm	0,8	4	175	9918440000
WK SI 1,0 x 5,5	max. 3.8 Nm	1	5,5	175	9918450000

WK IK PH

VDE-insulated interchangeable blades for VDE-insulated torque-screwdriver
output according to DIN 5260-PH, ISO 8764/1-PH



WK IK PH 0	max. 0.9 Nm			175	9918460000
WK IK PH 1	max. 3.8 Nm			175	9918470000
WK IK PH 2	max. 5.5 Nm			175	9918480000

WK IK PZ

VDE-insulated interchangeable blades for VDE-insulated torque-screwdriver
output according to DIN 5260-PZ, ISO 8764/1-PZ



WK IK PZ 0	max. 0.9 Nm			175	9918490000
WK IK PZ 1	max. 3.8 Nm			175	9918500000
WK IK PZ 2	max. 5.5 Nm			175	9918510000

Hinweis

DMSI scope of delivery contains adjustment tool

Section K – Marking Systems



This section has been removed from the catalog due to changes in technical information. Please refer to our web site – www.weidmuller.com for current literature on Marking Systems.

We apologize for any inconvenience.

Weidmüller 

General data

Certificates

W.2 - W.3

Electrical data

Rating the clearance and creepage distances W.4 - W.6

Current load curve W.7

General technical data

General information about CE marking W.8

EMV directives W.8 - W.9

Protection types W.10

Converting AWG conductors to mm² W.11

Gauge pin W.11

Materials

Insulation materials W.12 - W.13

Metals W.14

Current loading curves W.15

Connection types

W.16 - W.17

ATEX

W.18 - W.19

Specific data

Terminals

Regulations / definitions W.20

Assembling terminal strips W.21

Connecting terminals W.22

Use of aluminium conductors W.23

Definition of the various types W.24 - W.25

Ex terminals ATEX W.26 - W.29

CSQ is a member of **IONet**

CERTIFICATO N. 9105.WEID
CERTIFICATE N. 9105.WEID

SI CERTIFICA CHE IL SISTEMA QUALITÀ DI
 WEIDMULLER SRL
 UNITÀ OPERATIVA UNIFE
 VIA A. EINSTEIN, 4 - 20092 CINISELLO BALSAMO (MI)
 È IN CONFORMITÀ ALLA NORMA
 ISO 9001:2000

PER LE SEGUENTI ATTIVITÀ
 EA: 19

Commercializzazione di componenti per tecniche di interfacciamento elettronico (morsetti, per montaggio su guida di supporto, morsetti e connettori per circuito stampato, prodotti per l'installazione, moduli elettronici attivi, custodie, connettori per terminale) e realizzazione di moduli elettronici attivi per applicazioni particolari.
 Sales of components for electrical interface techniques (rail mounted terminals, PCB connectors, tools) and actualization of active components for peculiar applications where it involves sales quality per l'installazione dei morsetti della norma ISO 9001:2000.
 Realizzazione di certificati di qualità e sottoposto al rispetto del 2000 standard.
 Production of quality certificates and subjected to the requirements of the 2000 standard.
 PER LA CERTIFICAZIONE DEL SISTEMA QUALITÀ E DI OTTENERE DELLE ACCREDITAZIONI
 OF THE QUALITY SYSTEM AND TO OBTAIN ACCREDITATIONS

PRIMA EMISSIONE
 FIRST ISSUE
 1 giugno 1994

20 dicembre 2002

SINCERT

CERTIFIKAT

Nr 12335

Weidmüller AB
 Stockholm (Bandhagen), Malmö, Göteborg och Sundsvall.

Försäljning av komponenter för förbindning- och anslutningsteknik, elektronik samt apparater avsedda för industri-, process- och transportautomation. Kundenspecifikt montage av ovanstående.

Kvalitetssystemet är i överensstämmelse med
SS-EN ISO 9002:1994

Välkört och omfattning för detta certifikat finns angivna i certifieringsbeslutet

Kraft: 4 juli 2000

Guar. Strömberg
 SEMKO-DEKRA Certification AB

Utnäringscertifikat utställt 7 juni 1996

SEMKO-DEKRA

SEDEC

Deutsche Akkreditierungsstelle Technischer Profurlaboratorien

Deutscher Akkreditierung

Die Deutsche Akkreditierungsstelle Technischer Profurlaboratorien

Weidmüller Interfaced GmbH & Co. KG
 D-32750 Paderborn

die Kompetenz nach DIN EN ISO/IEC 17025 besitzend

Relais, Reihenklammern, Sicherheit elektronischer Betriebsmittel, Elektromagnetischer Verträglichkeit

den in der Anlage aufgeführten Normen und Spezifikationen

Akkreditierung ist gültig bis: 18.12.2007

Das Zertifikat ist Bestandteil der Urkunde und besteht aus 10 Seiten

Zertifikatsnummer: DAT-P-008/91-13

ausgestellt am: 12.12.2002

ausgestellt von: (FH) R. Egnor

Akkreditierungsstelle in der TGA - Trägergemeinschaft für Akkreditierung

KEMA REGISTERED QUALITY

PRODUCTION QUALITY ASSURANCE NOTIFICATION

(1) Equipment or Protective Systems or Components Intended for use in potentially explosive atmospheres Directive 94/9/EC

(2) KEMA 02ATEX03027

(3) This notification is issued for the following equipment or protective systems or components:
 Terminal blocks and grouped circuit terminal blocks in type of protection increased safety "n" and with dust ignition protection.
 Terminal boxes in types of protection increased safety "n", intrinsic safety flameproof enclosure "d" and with dust ignition protection.
 Field bus devices in types of protection increased safety "n", intrinsic safety "n" and with dust ignition protection.

(4) Manufacturer:
 Weidmüller Interface GmbH & Co.
 Paderbornerstraße 175
 32760 Detmold
 Germany

(5) Production site:
 Weidmüller Interface GmbH & Co.
 Paderbornerstraße 175
 32760 Detmold
 Germany

(6) VDMA Notified Body No. 0344 for Annex IV and VI in accordance with Article 9 of the Council Directive 94/9/EC of March 23, 1994 applies to the manufacturer that the production site has a quality system which complies in Annex IV and VI of the Directive.

(7) This notification is based on audit report No. 2002047, issued 4 September 2000.

(8) This notification can be withdrawn if the manufacturer no longer satisfies the requirements of Annex IV and VI.

(9) Results of periodical re-assessment of the quality system are a part of this notification.
 This notification is valid until 4 September 2003, and can be withdrawn if the manufacturer does not satisfy the quality assurance re-assessment.

(10) According to Article 10 (1) of the Directive 94/9/EC the notified body involved in the production control stage, in accordance with Article 6 (2) no components shall be affixed with the CE marking.

Amhem, 14 September 2000
 by order of the Board of Directors of N.V. KEMA

M. B. van der Vliet
 C.M. Bosman
 Chairman Director

Page 1/1

ACCREDITED BY THE DUTCH COUNCIL FOR ACCREDITATION

KEMA Registered Quality System
 Uitsluitend voor de CE-markering in de industrie en andere gebieden
 Uitsluitend voor de CE-markering in de industrie en andere gebieden
 Uitsluitend voor de CE-markering in de industrie en andere gebieden
 Uitsluitend voor de CE-markering in de industrie en andere gebieden

tuv CERT

ZERTIFIKAT

Die TÜV CERT-Zertifizierungsstelle TÜV NORD CERT GmbH & Co. bescheinigt gemäß TÜV CERT-Verfahren, dass das Unternehmen

Weidmüller GmbH & Co. KG
 D - 33102 Paderborn

für den Geltungsbereich

Vertrieb und Marketing von elektromechanischen Komponenten sowie Hardware - Bausteinen einschließlich der Unterstützung bei der Schaffung von Lösungen in der Automatisierungstechnik

Das Qualitätsmanagementsystem eingeführt hat und am 12.12.2002 durch den Nachweis erbracht, dass die Forderungen der Norm

DIN EN ISO 9001 : 2000

erfüllt sind.

Dieses Zertifikat ist gültig bis **Oktober 2005**
 Zertifikat-Registrier-Nr. 08 / 100 / 9535 / 6

Hannover, den 18. Dezember 2002

TÜV NORD CERT

hasegawa



Weidmüller quality and environmental management for the benefit of our customers

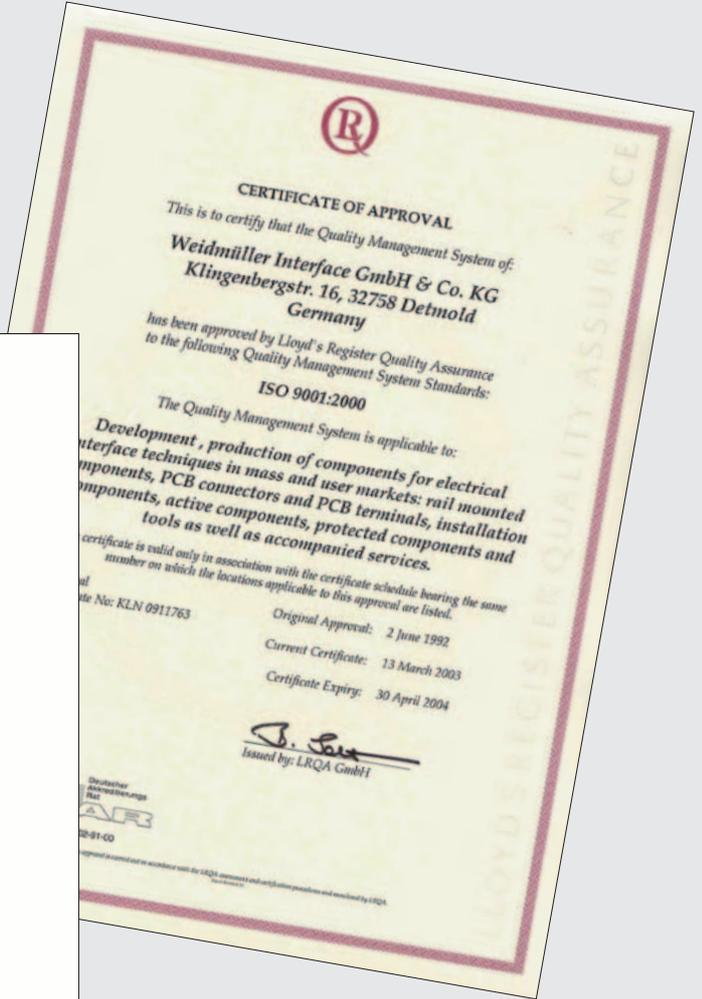

Product certificates create trust

Certification documents verify the quality of our products. They are issued following suitable tests by independent institutes and are the prerequisite for use in certain markets or fields of application.

The accredited test laboratory has its expertise endorsed

The reliability of technical data is of great importance for the user. In confirming the accredited status, officially approved authorities have certified the organisation in accordance with EN 45 001 as well as its expertise in defined assessment of terminals, plug-in connectors, relays and electronic equipment.

Certification as documentation of managed quality

Quality management in the Weidmüller companies is based on ISO 9000 ff. The corresponding certificates from acknowledged, accredited authorities also simplify your supplier appraisal procedures.



Verification of Weidmüller's quality also includes contracts with independent institutions covering the regular monitoring of production facilities, quality management and the laboratory.

Excellent environmental management testifies to our total commitment.

Rating the clearance and creepage distances of electrical equipment

General information

Since April 1997, clearance and creepage distances have been rated according to the regulations of DIN VDE 0110-1, "Insulation coordination for equipment in low voltage systems".

DIN VDE 0110-1 contains the modified version of the IEC report 664-1 (see IEC 664-1/10.92).

The latest catalogue gives the rating data obtained for each product in compliance with the provisions of this standard, where applicable.

For the rating of clearance and creepage distances, application of the regulations for insulation coordination produces the following interrelationships:

Clearance distances

Clearance distances are rated in accordance with the following factors:

- Anticipated overvoltage
Rated impulse voltage
- Used
Overvoltage protection precaution
- Measures to prevent soiling
Degree of Pollution Severity

Diagram showing clearance distance

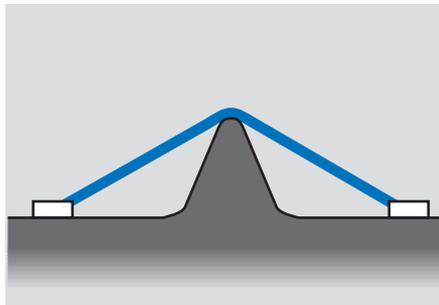

Creepage distance

Creepage distances are rated in accordance with the following factors:

- Intended
Rated voltage
- Used insulation materials
Insulation materials group
- Measures to prevent soiling
Degree of soiling

Diagram showing creepage distance

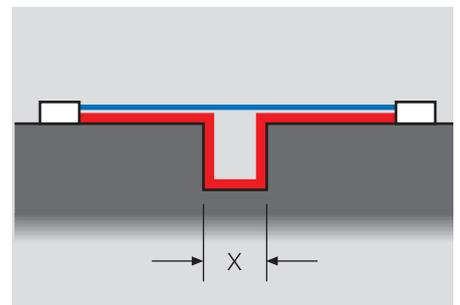
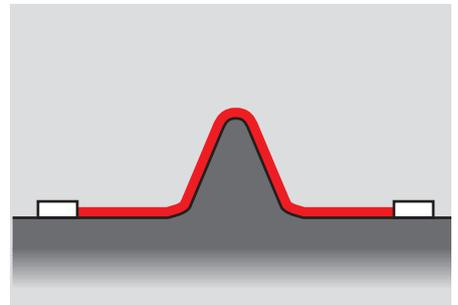

Grooves are taken into account when measuring creepage distances if their minimum width X is rated according to the following table:

Degree of soiling	Minimum width X in mm
1	0.25
2	1.0
3	1.5
4	2.5

If the corresponding clearance distance is less than 3 mm, the smallest groove width may be reduced to 1/3 of this clearance distance.

Electrical data

Rating the clearance and creepage distances of electrical equipment

Influential factors

Rated impulse voltage

The rated impulse voltage is derived from:

- **Voltage conductor – earth**
(the rated voltage of the network, taking into account all networks)
- **Overvoltage category**

Table 1: Rated impulse voltage for electrical equipment

Rated voltage of the power supply system *) in V		Rated impulse voltage in kV for			
Three-phase systems	One-phase systems with mid-point	Electrical equipment at the power supply of the installation (Overvoltage category IV)	Electrical equipment as part of the permanent installation (Overvoltage category III)	Electrical equipment for connection to the permanent installation (Overvoltage category II)	Specially protected electrical equipment (Overvoltage category I)
	120 to 240	4.00	2.50	1.50	0.80
230/400 277/480		6.00	4.00	2.50	1.50
400/690		8.00	6.00	4.00	2.50
1000		Values for project planning in each individual case. If no values are available, the values in the preceding line apply.			
*) acc. to IEC 38					

Stipulating the overvoltage categories

according to national standard DIN VDE 0110-1 (for electrical equipment fed directly from the low voltage network)

Overvoltage category I

- Devices for connection to the permanent electrical installation of a building. Outside the device, measures have been taken either in the permanent installation, or between the permanent installation and the device, to limit the transient overvoltage to the relevant value.

Overvoltage category II

- Devices for connection to the permanent electrical installation of a building,
e.g. domestic appliances, portable tools.

Overvoltage category III

- Devices which are an integral part of the permanent installation, and other devices expected to have a higher degree of availability.
e.g. distribution boards, circuit breakers, distribution devices (including cables, busbars, distribution boxes, switches, sockets) in the permanent installation and devices for industrial use, and other devices such as stationary motors with continuous connection to the permanent installation.

Overvoltage category VI

- Devices for use at or near the power supply in the electrical installation of buildings, between the principal distribution and the mains,
e.g. electricity meters, overcurrent protection switches and centralised controllers.

Degrees of Pollution Severity

Degree of Pollution Severity 1

- No or only dry non-conductive soiling. Soiling has no influence.

Degree of Pollution Severity 2

- Only non-conductive soiling. Temporary conductivity must be expected occasionally as a result of condensation.

Degree of Pollution Severity 3

- Conductive soiling occurs, or dry non-conductive soiling which becomes conductive because of condensation.

Degree of Pollution Severity 4

- Soiling results in constant conductivity, e.g. caused by conductive dust, rain or snow.

Unless explicitly stated otherwise, the dimensioning of clearance and creepage distances, and hence the thus-derived rating data for electromechanical products (terminals, terminal strips, PCB connection terminals and plug-in connectors) is based on degree of soiling 3 and overvoltage category III, taking account of all network types.

Electrical data

Rating the clearance and creepage distances of electrical equipment

Influence factors

Rated voltage

The rated voltage is derived from the rated voltage of the power supply and the corresponding network type.

Table 3a:
Single phase 3 or 2 conductor a.c. or d.c. networks

Rated voltage of the power supply system (network*)	Voltages for table 4	
	for insulation conductor-conductor ¹⁾	for insulation conductor – earth ¹⁾
	all systems	3-conductor systems, with mid-point earthing
V	V	V
12.5	12.5	–
24 / 25 30	25 32	–
42 / 48 / 50 ^{**)} 60	50 63	–
30-60	63	32
100 ^{**)}	100	–
110 / 120 150 ^{**)}	125 160	–
220	250	–
110-220 120-240	250	125
300 ^{**)}	320	–
220-440	500	250
600 ^{**)}	630	–
480-960	1000	500
1000 ^{**)}	1000	–

Table 3b:
Three-phase 4 or 3 conductor a.c. networks

Rated voltage of the power supply system (network*)	Voltages for table 4		
	for insulation conductor – conductor	for insulation conductor – earth	
	all systems	three-phase 4-conductor systems with earthed neutral ²⁾	three-phase 3-conductor systems; unearthed ¹⁾ or earthed conductor
V	V	V	V
60	63	32	63
110/120/127	125	80	125
150 ^{**)}	160	–	160
208	200	125	200
220/230/240	250	160	250
300 ^{**)}	320	–	320
380/400/415	400	250	400
440	500	250	500
480/500	500	320	500
575	630	400	630
600 ^{**)}	630	–	630
660/690	630	400	630
720/830	800	500	800
960	1000	630	1000
1000 ^{**)}	1000	–	1000

1) Conductor-earth insulation levels for unearthed or impedance earthed systems are the same as those for conductor-conductor insulation because, in practice, the operating voltage of every conductor to earth can match the conductor-conductor voltage. This is because the actual voltage to earth is defined by the insulation resistance and by the capacitive blind resistance of every conductor to earth. This means that a low (but tolerated) insulation resistance of a conductor can effectively earth it and raise the other two to the value of the conductor-conductor voltage against earth.

2) For electrical equipment intended both for use in three-phase 4-conductor and in three-phase 3-conductor systems, both earthed and unearthed, only the values for the 3-conductor systems should be used.

*) It is presumed that the value of the rated voltage of the electrical equipment is not below the value of the rated voltage of the power supply system.

***) Following jointly undertaken alterations, the meaning of the **) marking has not been adopted in Table 1. Its definition: the /- dash refers to a three-phase 4-conductor system. The lower value is the voltage 'external to neutral conductor', the higher value is the voltage 'external to external conductor'. If only one value is stated, it refers to three-phase 3-conductor systems and refers to the voltage 'external to external conductor'.

Tables 3a and 3b still refer to the values in Table 1 by using the **) marking.

Insulation material group

The insulation materials are divided into four groups depending on the comparative figures for creepage distance (CTI: comparative tracking index):

Insulation material group

I	$600 \leq \text{CTI}$
II	$400 \leq \text{CTI} < 600$
III a	$175 \leq \text{CTI} < 400$
III b	$100 \leq \text{CTI} < 175$

The comparative tracking index is required to have been determined using special samples produced for this purpose with test solution A in compliance with IEC 60112 (DIN IEC 60112/DIN VDE 0303-1).

Electrical data

Current load curve (derating curve)

Basic curve

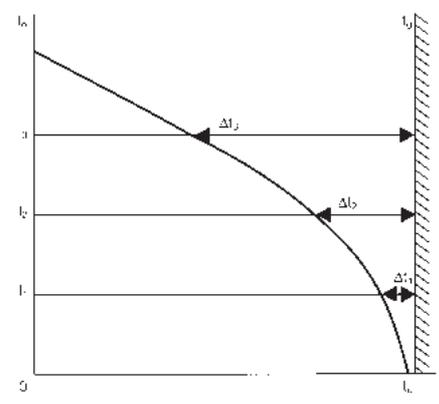

t_g = upper temperature limit of component
 t_u = ambient temperature of component
 I_n = load current

Current loading curve

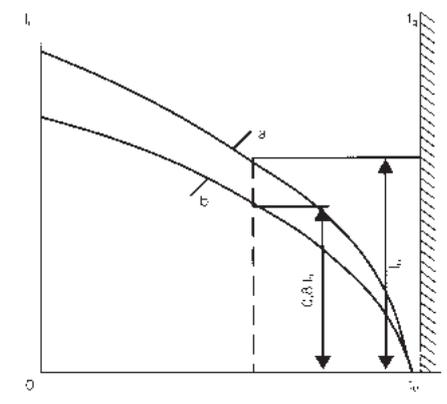

t_g = upper temperature limit of component
 t_u = ambient temperature of component
 I_n = load current
 a = basic curve
 b = reduced basic curve (current loading curve)

The **derating curve** shows which currents can flow continuously and simultaneously across all possible connections when the component is exposed to various ambient temperatures below its upper temperature limit.

The **upper temperature limit** of a component is a rating value which depends on the used materials. The sum of ambient temperature and overtemperature produced by the current load (power loss at the forward resistance) must not exceed the upper temperature limit of the component, so as not to damage or destroy it. The current loading ability is therefore not a constant value but falls with increasing component ambient temperature. In addition, the power loading ability is influenced by component geometry, number of pins and connected conductor.

The current loading ability is empirically determined acc. to DIN IEC 60152-3.

For this purpose, the corresponding component temperatures t_{b1} , t_{b2} and the ambient temperatures t_{u1} , t_{u2} are measured for three different loading currents I_1 , I_2 ...

The values are entered in a linear system of coordinates (as shown in Fig. 1) to illustrate the relationships between the loading currents, the component ambient temperature and the component overtemperature.

The Y-axis is used for the **loading currents** and the X-axis for the **ambient temperatures**. A perpendicular on the X-axis at the component's upper temperature limit t_g completes the coordinate system

For every current I_1 , I_2 , .. the corresponding mean values for component overtemperatures $\Delta t_1 = t_{b1} - t_{u1}$, $\Delta t_2 = t_{b2} - t_{u2}$, are entered starting from the perpendicular and working to the left.

The points found in this way are connected to form a parabolic curve.

In view of the fact that it is effectively not possible to select components with maximum permissible forward resistances for measurement purposes, the basic curve has to be reduced. A reduction of the loading currents to 80% results in the **"power loading curve"**. Here allowance has to be made for the maximum tolerable forward resistances and inaccuracies incurred in measuring the temperatures, so that these curves are adequate for practical use as indicated by experience. If, within the low ambient temperature range, the current loading curve exceeds the current permissible as based on the current loading ability of the conductor cross-sections requiring connection, then the current loading curve is limited to the smaller current for this temperature range.

General information about CE marking

The CE mark on various products and their packaging is neither a quality feature nor an indication of quality or safety. The CE mark is a control sign that was created and brought into effect for open trading within the European market. It does not refer to the address of the end consumer. The CE mark only confirms that a manufacturer has complied with all of the directives of the European Union (EU) that are applicable to this product. Therefore the CE mark is proof of directive conformity and is directed towards the responsible control authorities.

The CE mark can be said to be the passport for products that are to be traded within Europe.

Weidmüller considers all relevant EU directives to the best of its knowledge. The currently applicable directives are as follows:

73/23/EEC

Electrical equipment for use within specific voltage ranges (Low voltage directive)

89/336/EEC

Electromagnetic compatibility (EMC directive)

98/392/EEC

Safety of machines (Machinery directive)

The standards mentioned in the directives have been an element of Weidmüller's standard development for a considerable time. This provides the guarantee of conformity to the European directives. Our testing laboratory, accredited according to EN 45001, performs the standard conform testing. The testing reports are recognised within Europe within the framework of the accreditation process.

73/23 EEC

Low-Voltage Directive (LVG)

Electrical equipment in the sense of this directive are all electrical equipments that are used with a nominal voltage between 50 and 1000 Vac and between 75 and 1500 Vdc.

If an electrical product has the CE mark, it must fulfil the requirements of the EMC directive and if necessary the low-voltage directive (above 50 Vac and above 75 Vdc).

EMC directives

According to the low-voltage directive, a conformity evaluation process must be performed on the product whereby conformity to the directive is assumed where a reference to the harmonised European standards or to the other technical specifications, e.g. IEC standards or national standards, is made.

With the decree of the Directive of the council dated 3rd. May 1989 for the alignment of the legal requirements of the member states concerning **electromagnetic compatibility** (89/336/EEC), the European Union (EU) has declared **EMC** as a protection objective.

The protection objectives are defined in article 4 of the EMC directive dated 19th. November 1992, and state the following:

- the generation of electromagnetic interference must be so reduced so that the intended operation of radio, telecommunications and other devices is possible.
- the devices must have a suitable resistance to electromagnetic interference in order to ensure intended operation.

Devices are defined in the EMC directive as:

- all electrical and electronic equipment, installations and systems that contain electrical and electronic components

This applies to active/passive components and intelligent modules that are produced and stored by Weidmüller.

The adherence to this directive is assumed for the devices that conform with the harmonised European standards that, for example, are released in the gazette from the Federal Minister for Post and Telecommunications.

The devices are utilised in the following areas:

- industrial installations
- medical and scientific equipment and devices
- information technology devices

Weidmüller tests its electronic products according to the relevant standards in order to fulfil the agreed protection objectives.

Electronic Products from Weidmüller Regarding EMC Guidelines

Category 1

All passive components such as:

- terminals with status displays
- protection terminals with status displays
- passive interface elements with and without status displays
- overvoltage protection

These products cause no interference and they have a suitable immunity to interference. These products are not labelled with the CE mark concerning the EMC directive or the EMC guideline.

Category 2

These products are labelled with the CE mark after the conformity evaluation process has been performed which contains the reference to the harmonised European standards.

The following are harmonised standards:

EN 50081-1

Generic Emission Standard for residential, commercial and light industrial environments

EN 50082-1

Generic Immunity Standard for residential, commercial and light industrial environments companies

EN 50081-2

Generic Emission Standard for heavy industrial environments

EN 50082-2

Generic Immunity Standard for heavy industrial environments

EN 55011

Radio Interference for ISM Devices

EN 55022

Radio Interference for Information Technology Facilities

EN 61000-3-2

Harmonics

EN 61000-3-3

Voltage Fluctuations

EN 61000-4-x

approx. 10 partial tests for interference immunity; partly not ratified.

General technical data

EMC directives

Usage of Tests

Generic standards are always used when device-specific product standards do not exist. The generic standards of EN 50081-2 and EN 50082-2 are used as the basis for Weidmüller products.

Remark:

The relevance of EN 50082-1 for certain products must be checked as well as how far EN 50081-1 or 50082-1 was considered during testing.

The environment phenomenon and test interference levels are specified in the generic immunity standard. Additionally, Weidmüller considers the evaluation criteria A, B and C.

Text extract from the Generic Standard EN 50082-2:

Criterion A

The equipment shall continue to operate as intended. No degradation of performance or loss of function is allowed below a minimum performance level as specified by the manufacturer, when the equipment is used as intended.

In certain cases, the nominal performance level can be replaced by an permissible loss of performance.

If the minimal performance level or permissible loss of performance is not specified by the manufacturer, both of these specifications can be extracted from the description of the product, the relevant documentation and from what the operator expects from the equipment during its intended operation.

Criterion B

The equipment shall continue to operate as intended after the test. No degradation of performance or loss of function is allowed below a minimum performance level as specified by the manufacturer, when the equipment is used as intended.

In certain cases, the minimal performance level can be replaced by an permissible loss of performance. During testing degradation of the performance level is permitted however changes to the specified operation mode or data loss are not permitted.

If the minimal performance level or permissible loss of performance is not specified by the manufacturer, both of these specifications can be extracted from the description of the product, the relevant documentation and from what the operator expects from the equipment during its intended operation.

Criterion C

A temporary loss of function is permitted, provided the loss of function is self recoverable or can be restored by the operation of the controls.

Criterion B is most frequently specified in the generic standards and is used by Weidmüller.

An example of an analogue coupler EMA:

During testing, the analogue coupler can convert values that are outside the permissible tolerances.

After testing however, the values must be within the available tolerances.

General Installation Instructions

In agreement with the performance level and the criteria A and B, the products are allowed and can be affected externally during the occurrence of a fault.

It should be attempted, as far as possible, to prevent this with an optimal installation.

Measures:

- installation of the products in an enclosed metal box (control cabinet, metal housing)
- protect the voltage supply with an overvoltage protection device. (For mains supply of 230/400 Vac with a PU type and for 24 Vdc with an EGU or LPU.)
- only use shielded cables for analogue data signals
- follow ESD measures during installation, maintenance and operation
- distance between electronic modules and interference sources (e.g. invertors) and power lines should be at least 200 mm.
- maintenance of ambient temperature and relative humidity
- long cables are to be protected by over-voltage protection devices.

For safety reasons, the operation of walkie-talkies and mobile telephones should only be performed outside a radius of 2 m.

General technical data

Protection rating according to EN 60 529 / DIN 0470

The protection ratings are indicated by a code consisting of the two invariable letters IP and two digits representing the degree of protection.

Example:

I P 6 5

2nd digit: protection from water
1st digit: protection from solid bodies

Degrees of protection from solid foreign bodies (1st digit)

Number	
0	Not protected
1	Protected from solid foreign bodies 50 mm in diameter and above. Protection to prevent dangerous parts being touched with the back of the hand.
2	Protected from solid foreign bodies 12.5 mm in diameter and above. Protection to prevent dangerous parts being touched with the fingers (finger-safe).
3	Protected from solid bodies 2.5 mm in diameter and above. Protection to prevent dangerous parts being touched with a tool.
4	Protected from solid bodies 1 mm in diameter and larger. Protection to prevent dangerous parts being touched with a piece of wire.
5	Dust protected. Penetration of dust is not completely prevented, but dust must not penetrate in quantities that would impair satisfactory working of the device or safety.
6	Dust-proof, no penetration by dust.

Degrees of protection from water (2nd digit)

Number	
0	Not protected
1	Vertically falling drops must not have any harmful effect.
2	Vertically falling drops must not have any harmful effect if the housing is inclined at an angle of up to 15° to the vertical on both sides.
3	Water sprayed at an angle of up to 60° to the vertical on both sides must not have a harmful effect.
4	Water splashing against the housing from any direction must not have a harmful effect.
5	Water sprayed against the housing from any direction must not have a harmful effect.
6	Water aimed in a strong jet against the housing from any direction must not have a harmful effect.
7	Water must not penetrate in any quantity which causes harmful effects if the housing is temporarily submerged in water under standard pressure and time conditions.
8	Water must not penetrate in any quantity which causes harmful effects if the housing is permanently submerged in water under conditions which must be agreed between manufacturer and user. However, the conditions must be more adverse than under number 7.

General technical data

Converting AWG conductors to mm²

Gauge pin acc. to IEC 60947-1 section 8.2.4.5.2 table 7

AWG is the abbreviation for “**A**merican **W**ire **G**auge”. This gives no indication of the actual conductor cross-sectional area.

The relationship between AWG and mm² is shown in the following table.

Possibility of inserting unprepared round conductors with the largest stipulated cross-sectional area

Testing with stipulated gauge, inserted under own weight.

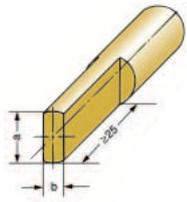
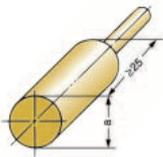
AWG	mm ²	Conductor cross-sectional area		Pin					
				Form A			Form B		
									
		Flexible conductor mm ²	Rigid conductor (single- or multi-core) mm ²	Designation	Diameter a mm	Width b mm	Designation	Diameter a mm	Tolerable deviations for a and b mm
28	0.08								
26	0.13								
24	0.21								
22	0.22								
20	0.52								
19	0.65								
18	0.82								
17	1.04								
16	1.31								
15	1.65								
14	2.08								
13	2.63								
12	3.31								
11	4.17								
10	5.26	1.5	1,5	A 1	2.4	1.5	B 1	1.9	
9	6.63	2.5	2,5	A 2	2.8	2.0	B 2	2.4	0 – 0.05
8	8.37	2.5	4	A 3	2.8	2.4	B 3	2.7	
7	10.55	4	6	A 4	3.6	3.1	B 4	3.5	
6	13.30	6	10	A 5	4.3	4.0	B 5	4.4	0 – 0.06
5	16.77	10	16	A 6	5.4	5.1	B 6	5.3	
4	21.15	16	25	A 7	7.1	6.3	B 7	6.9	
3	26.67	25	35	A 8	8.3	7.8	B 8	8.2	0 – 0.07
2	33.63	35	50	A 9	10.2	9.2	B 9	10.0	
1	42.41	50	70	A 10	12.3	11.0	B 10	12.0	
0	53.48	70	95	A 11	14.2	13.1	B 11	14.0	0 – 0.08
		95	120	A 12	16.2	15.1	B 12	16.0	
		120	150	A 13	18.2	17.0	B 13	18.0	

Materials

Insulation materials

In order to satisfy all the different requirements made of our products, we have to use various insulation materials tailor-made to each specific application.

All insulation materials used by Weidmüller are free from harmful substances. It is especially important that these materials contain no cadmium. In addition, they are free from heavy metal colour pigments, dioxin and furan-forming substances.

Thermosetting plastics

Plastic Abbreviation

Germin KrG

Stamin KrS

Epoxy resin EP

Thermosetting plastics have outstanding dimensional stability, low water absorption, excellent creepage current resistance and outstanding fire resistance.

Their continuous service temperature is higher than that of thermoplastics. Under high thermal load, thermosetting plastics have better dimensional strength than thermoplastics.

Thermosetting plastics are, however, inferior to thermoplastics in terms of their flexibility.

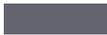
Plastic Abbreviation	Germin KrG	Stamin KrS	Epoxy resin EP
	Melamine resin pressing compound MF type 150 (DIN EN ISO 14 528) Organic filler	Melamine resin pressing compound MF type 156 (DIN EN ISO 14 528) Inorganic filler	Epoxy resin with inorganic filler
Colour	mid-yellow 	anthracite 	black 
Description	high continuous service temperature high fire resistance high creepage current resistance inherent flammability protection	continuous service temperature higher (than Germin) high fire resistance high creepage current resistance inherent flammability protection	very good electrical properties very high continuous service temperature resistant to high-energy radiation halogen- and phosphorous-free; flame retardant
Properties			
Specific forward resistance acc. to IEC 93	10 ¹¹	10 ⁸	10 ¹⁴
Dielectric strength acc. to IEC 243-1	10	12.5	160
Creepage current resistance (A) to IEC112	≥ 600	≥ 600	≥ 600
Upper max. tol. limit temperature	130	140	160
Lower max. tol. limit temperature, static	- 60	- 60	- 60
Combustibility acc. to UL 94	V-0 (5 V-A)	V-0 (5 V-A)	V-0
Fire behaviour acc. to railways standard			

Materials

Thermoplastics

Wemid	Polyamide PA	Polyamide PG GF	Polybutylene terephthalate PBT	Polycarbonate PC
<p>Wemid is a modified thermoplastic whose properties are especially tailored to make it suitable for use in our power connectors. Advantages over PA include enhanced fire protection and higher continuous service temperature. Wemid fulfils the strict requirements for use in railway vehicles according to NF F 16-101.</p>	<p>Polyamide (PA) is one of the most frequently used technical plastics. The advantages of this material includes its very good electrical and mechanical properties, flexibility and resistance to breakage. In addition, its chemical structure gives PA good fire resistance even without the use of flame retardants.</p>	<p>Glass-fibre reinforced polyamide (PG GF) offers excellent dimensional stability and very good mechanical properties. This makes it ideal for use as end bracket. Unlike PA, this material in unreinforced state comes under combustibility class HB in accordance with UL 94.</p>	<p>Thermoplastic polyester (PBT) offers excellent dimensional stability (which is why it is used for plug-in connectors) and high continuous service temperature. It has lower creepage current resistance than other insulation materials.</p>	
special Weidmüller insulating material	insulating material	insulating material	with or without glass-fibre reinforcement, depending on use	with or without glass-fibre reinforcement, depending on use
dark beige 	beige 	dark beige 	orange 	grey 
<p>higher continuous service temperature</p> <p>enhanced fire resistance</p> <p>halogen- and phosphorous-free; flame retardant</p> <p>low smoke</p> <p>permitted for use in railways acc. to NF F 16-101</p>	<p>flexible, resistant to breakage</p> <p>good electrical and mechanical properties</p> <p>self-extinguishing properties</p>	<p>excellent dimensional stability</p> <p>very good mechanical properties</p>	<p>high dimensional stability</p> <p>good electrical and mechanical properties</p> <p>flame retardant, without dioxin and furan-forming substances</p>	<p>high dimensional stability</p> <p>high continuous service temperature</p> <p>high electrical insulating power</p> <p>halogen-free; flame retardant</p>
10 ¹²	10 ¹²	10 ¹²	10 ¹³	10 ¹⁶
25	30	30	28	≥ 30
600	600	500	200	≥ 175
120	100	120	115 / 130	115 / 125
- 50	- 50	- 50	- 50	- 50
V-0	V-2	HB	V-0	V-2 / V-0
I2 / F2 *)				I2 / F2
*) also qualified acc. to LUL E 1042				

Metals

Weidmüller uses only tried and tested materials for the electrical components in its products.

All materials are subjected to rigorous quality monitoring under a quality management system certified to DIN EN ISO 9001.

Environmental compatibility plays a crucial role in the selection of materials.

All metals used by Weidmüller are selected, processed and surface-treated according to the very latest technical findings.

Steels

Steel parts whose function is to permanently maintain contact force are zinc electroplated, with an additional chromate layer added to provide additional passivation.

Surface protection complies with the very highest standards. Results from laboratory tests are incorporated in producing the surface finish.

Zinc still offers corrosion protection over a longer period of time even if the zinc coating is partially damaged by scratches or pores.

Zinc acquires a negative charge in relation to steel under the influence of an electrolytic fluid. The metal ions in the zinc migrate to the steel giving the base material lasting protection against corrosive attack.

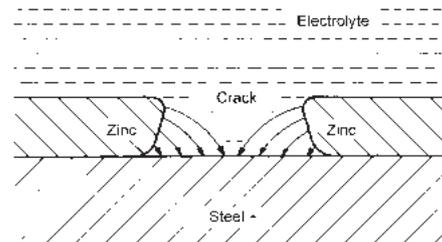

Conductive materials

The current-carrying materials copper, brass and bronze are characterised by both high conductivity and good mechanical properties.

The surfaces are usually finished with tin plating. This guarantees that the contact has outstanding “adaptive” properties with low transition resistance. The tin plating not only gives consistently good electrical properties but also affords excellent protection from corrosion.

Soldered connections are also provided with tin plating. To safeguard soldering ability over longer periods of time (storage periods), brass parts are also given an additional nickel layer to serve as a diffusion barrier.

The nickel layer is highly effective in preventing zinc atoms from diffusing out of the brass.

Current loading curves

The maximum current which a terminal can carry depends on:

- the inherent temperature rise of the terminal
- the ambient temperature
- the cross-sectional area of the connected conductor

An upper service temperature has been defined for every Weidmüller terminal, and this must not be exceeded in continuous operation.

The continuous service temperature depends on the insulation material used in the terminal. According to EN 60 947-7-1, a terminal may not heat up by more than 45 K.

When the input current is at least equivalent to the rated current, the maximum ambient temperature to which a terminal may be subjected is equal to the continuous service temperature for the insulation material used, less the maximum tolerable temperature rise of the terminal acc. to EN 60 947-7-1.

Figs. 1–3 show examples of current heating curves (in this case for a rated current of 32 A) for three different insulating materials:

- Thermoplastic (polyamide 66)
- WEMID
- Duroplastic (MF 150 KrG)

Depending on the insulation material used, the rating current can be conducted up to an ambient temperature of 55 °C for PA 66, 75 °C for Weidmüller's insulation material WEMID, or up to 85 °C for duroplastic insulation materials (KrG).

Above these temperature limits, the current is to be reduced in accordance with the current expectancy curves.

**Current loading curve
for upper continuous service temperature 100°C – polyamide 66**

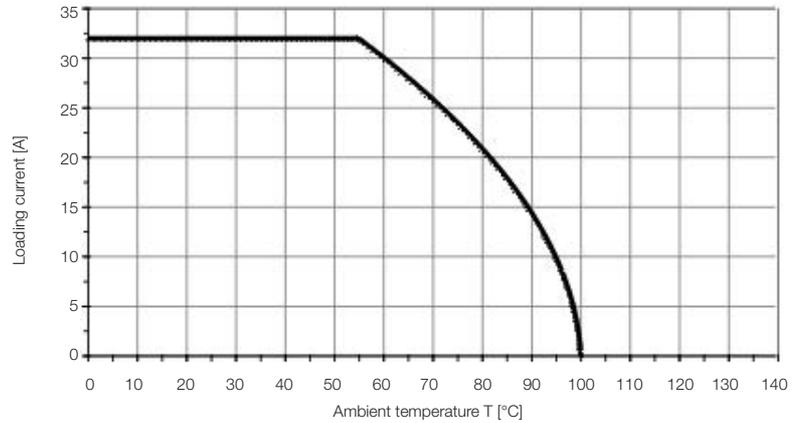

**Current loading curve
for upper continuous service temperature 120°C – Wemid**

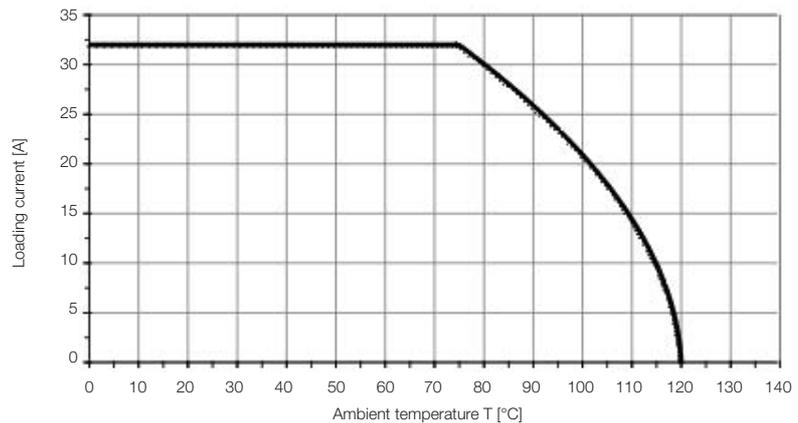

**Current loading curve
for upper continuous service temperature 130°C – MF 150 KrG**

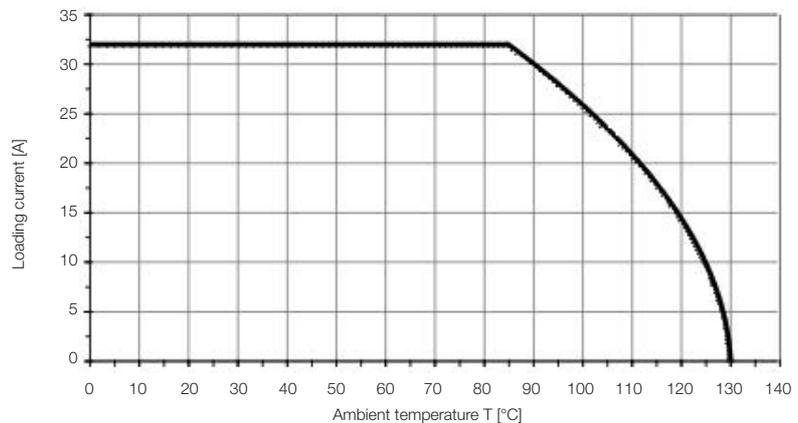

Connection types

Clamping yoke connection

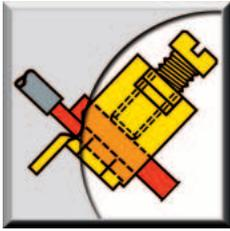

Weidmüller's tension clamp system optically combines the specific properties of steel and copper. The system has proven its worth billions of times over in various Weidmüller products. Both the tension clamp and the clamping screw consist of hardened steel. This clamping yoke unit generates the necessary contact force. Connection of the conductor involves the tension clamp pressing the conductor against the busbar, which is made of copper or high-quality brass. Weidmüller's tension clamp produces a gas-tight, vibration-resistant connection between the conductor and the busbar.

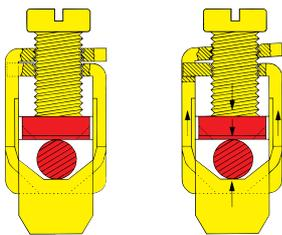

Vibration resistance

The force generated by turning the clamping screw means that the upper thread overlap springs back and exerts a counter-effect on the screw.

Weidmüller's tension clamp system is vibration-resistant.

Any settling of the connected conductor is counteracted by the elastic behaviour of Weidmüller's tension clamp. This means it is not necessary to "tighten" the clamping screw.

Pressure clamp connection

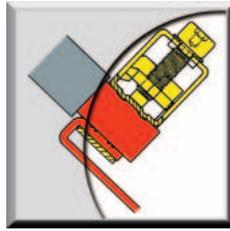

With its patented **pressure clamp connection**, Weidmüller has developed a screw connection system for conductors with large cross-sectional areas. The screw unit can be taken right out of the terminal, making it easier to insert larger conductors (which often otherwise proves difficult). The conductor is placed directly on the busbar, the screw unit replaced and the conductor clamped in position.

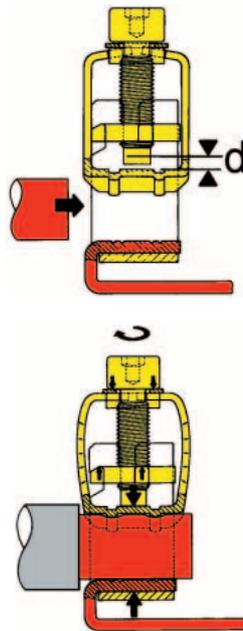

Vibration resistance

The difference in length "d" between the shank of the clamping screw and the resilient pressure clamp means that the pressure clamp undergoes elastic deformation when the screw is tightened. The high spring force of the pressure clamp gives rise to vibration resistance and at the same time counteracts the tendency for the connected conductor to settle. It is not, therefore, necessary to "tighten" the clamping screw.

TOP connection

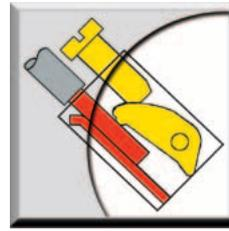

Weidmüller's TOP connection system fulfils the requirement that conductor insertion and screw actuation take place in parallel. This brings wiring advantages in certain installation situations, for example with close lateral spacing in installation boxes. The TOP connection system combines the special properties of steel and copper. The hardened steel pressure clamp presses the conductor directly against the copper or brass busbar. The high contact force guarantees a gas-tight connection between conductor and busbar.



Vibration resistance

The force exerted by the steel pressure clamp when the screw is tightened pulls the two halves of the TOP connection thread apart, as in the tension clamp. This exerts a braking effect on the screw and guarantees outstanding vibration resistance.

Connection types

Tension clamp connection

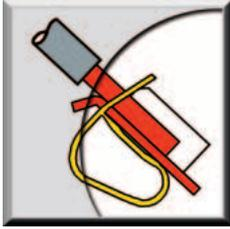

Weidmüller's tension clamp system functions in similar fashion to the tried and tested clamping yoke. As with the latter, the tension clamp preserves the separation of mechanical and electrical functions. The tension clamp of high-quality rust- and acid-resistant steel pulls the conductor against the galvanised copper busbar. The surface-treated busbar has low contact resistance and is highly resistant to corrosion. These properties are preserved by the balancing effect of the tension clamp.

IDC technology

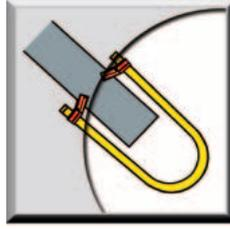

IDC (insulation displacement connection) technology is a means of connecting copper conductors which involves absolutely no preparation of the conductor – in other words, no stripping and no crimping.

When the conductor is connected, its insulation is penetrated and, at the same time, the electrical contact is produced between the conductor and the busbar.

As with the other types of connection, Weidmüller's IDC principle ensures separation of mechanical and electrical functions.

A stainless steel spring presses the busbar against the conductor, thus guaranteeing low contact resistance and a gas-tight, vibration-resistant connection.

Direct push in technology

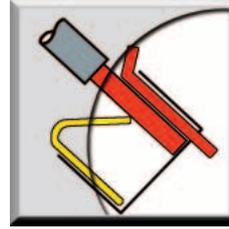

Direct push in technology involves the stripped solid conductor simply being pushed into the terminal as far as it will go – that's all there is to it. No tools are required, and a reliable, vibration-resistant and gas-tight connection is produced. Even flexible conductors with crimped wire end ferrules or ultrasonic welded conductors can be connected without any problems.

A stainless steel spring, held in a separate cage, guarantees that the conductor exerts a strong contact force on the busbar (copper- and tin coated). The conductor pull-out forces are even higher here than in the tension spring system.

In the steel cage, a spring and a conductor stopper guarantee optimum conditions for connection and guide the screwdriver for the purpose of releasing the conductor.

ATEX

ATEX 95 (formerly ATEX 100a)

The former directive for Ex protection issued by the European Council under 76/117 EEC became invalid with effect from 1 July 2003. Now only directive 94/9/EEC or ATEX 95 applies (ATEX: Atmosphère Explosive); this is one of the so-called "new approach" directives. It applies in all countries of the European Union together with Iceland, Liechtenstein and Norway.

In these countries it refers to the sale and commissioning of products which have been specially developed for areas in which the presence of gases, vapours, fog or dust give rise to a potentially explosive atmosphere. It now also covers the mining industry and purely mechanical devices.

The ATEX directive has been in force since March 1996. It was valid on an optional basis through to 30 June 2003 (interim period) in parallel to the existing directives. As of this date, all new systems and devices for installation in explosion-risk areas must conform with the ATEX directive and be certified accordingly. The former categorisation into zones (zone 0, 1 or 2) and protection classes (e.g. "i": inherent safety, "e" enhanced safety) still apply.

Protection class

Protection	Code	CENELEC EN	IEC	Device category explosion-protected
Gen. requirements	–	50014	60079-0	–
Oil encapsulation	o	50015	60079-6	2
Overpressure encapsulation	p	50016	60079-2	2
Sand encapsulation	q	50017	60079-5	2
Pressure-resistant encapsulation	d	50018	60079-1	2
Increased safety	e	50019	60079-7	2
Inherent safety	ia	50020	60079-11	1
Inherent safety	ib	50020	60079-11	2
Type n (EEx n)	n	50021	60079-15	3
Sealing encapsulation	m	50028	60079-18	2

Classification for explosion-risk areas

CENELEC classification IEC60079-10	Presence of a potentially explosive atmosphere	Device category	US Classification NEC 500	Flammable media
Zone 0	constant, long-term	1G	Class I, Div 1	Gases, vapours
Zone 20	or frequent	1D	Class II, Div 1	Dust
Zone 1	occasional	2G	Class I, Div 1	Gases, vapours
Zone 20		2D	Class II, Div 1	Dust
Zone 2	rare and	3G	Class I, Div 2	Gases, vapours
Zone 22	short-term	3D	Class II, Div 2	Dust

Explosion groups

Gas (e.g.)	CONELEC	NEC 500
Propane	IIA	D
Ethylene	IIB	C
Hydrogen	IIC	B
Acetylene	IIC	A
Methane (mining)	I	Mining (MSHA)

Temperature classes

Max. surface temperature (°C)	Temperature class CENELEC	Temperature class NEC 500-3
450	T1	T1
300	T2	T2
280	–	T2A
260	–	T2B
230	–	T2C
215	–	T2D
200	T3	T3
180	–	T3A
165	–	T3B
160	–	T3C
135	T4	T4
120	–	T4A
100	T5	T5
85	T6	T6

ATEX

ATEX 95 (formerly ATEX 100a)

Marking example Terminal WDK 4 N V

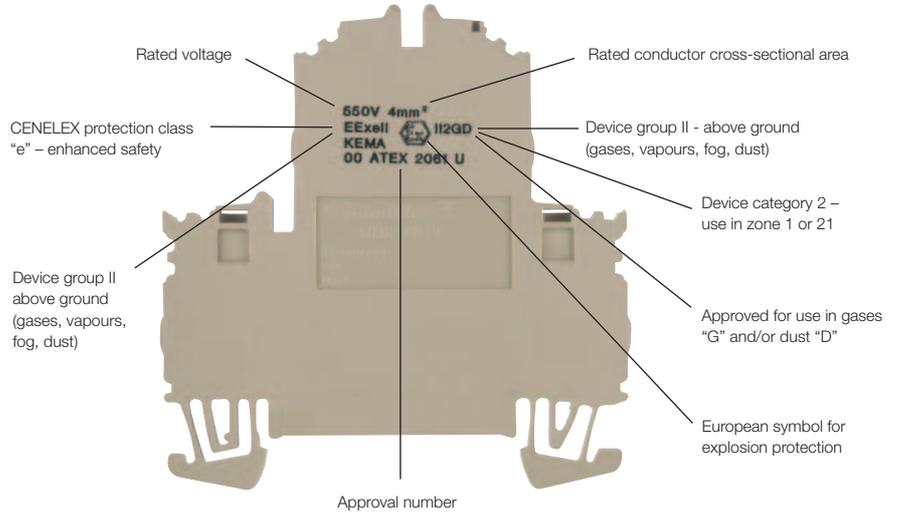

Example of marking Assembled enclosure for enhanced safety

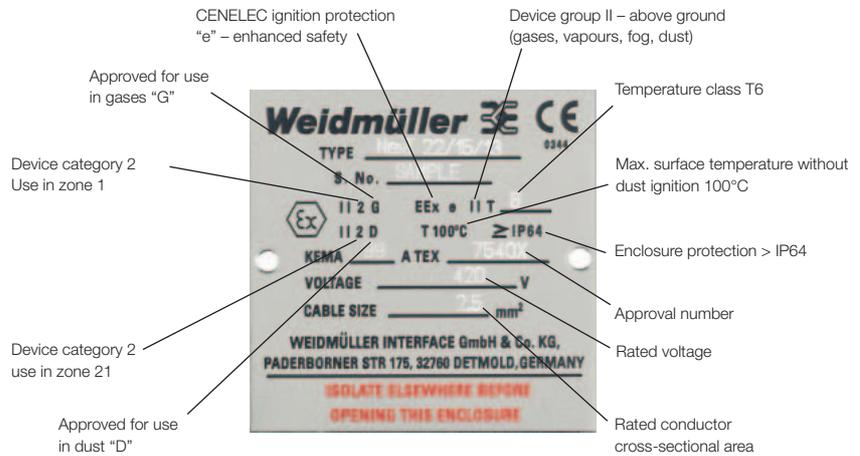

Regulations / definitions

Terminals acc. to VDE 0611-1

This standard was published in Germany in August 1992:

VDE 0611-1 Low-voltage switchgear part 7: Ancillary equipment section 1 – Terminal blocks for copper conductors.

The contents of this standard correspond to the international standard:

IEC 60947-7-1:

1989 Low voltage switchgear and control gear part 7: Ancillary equipment section 1 – Terminal blocks for copper conductors

At the European level this standard has been ratified by CENELEC, making it valid in the following countries:

Austria, Belgium, Denmark, Finland, France, Germany, Greece, Holland, Iceland, Ireland, Italy, Luxembourg, Norway, Portugal, Spain, Sweden, Switzerland, United Kingdom

Combined application in order of priority: IEC 60947-1

Low-voltage switchgear and control gear part 1: General Rules

EN 60947-1

VDE 0660 part 100

Low-voltage switchgear part 1:

General Rule

Scope VDE 0611-1

(EN 60947-7-1)

(IEC 60947-7-1)

This standard stipulates the requirements for terminals with screwed or screwless terminal strips intended primarily for industrial or similar use, with the terminals fastened to a carrier to produce both electrical and mechanical connections between copper conductors. It applies to terminals used for connecting round copper conductors with a cross-section between 0.2 mm² and 300 mm² (AWG 24/600 kcmil), and for electronic circuits up to 1000 Vac 1000 Hz or up to 1500 Vdc.

Remarks:

This standard is also used as guide for special kinds of terminals (e.g. isolating terminals) for which no special standards are available.

Terminals/ feed-through terminals

An insulating part which carries one or several mutually insulated terminal arrays intended for fastening to a carrier.

Rated cross-section

The rated cross-section of a terminal is the cross-section of the conductor to be connected by the terminal as stated by the manufacturer. It is determined by certain thermal, mechanical and electrical requirements, and is one of the specifications marked on the terminal.

The rated cross-section is selected from the following standard cross-sections:

0.2 – 0.5 – 0.75 – 1 – 1.5 – 2.5 – 4 – 6 – 10 – 16 – 25 – 35 – 50 – 70 – 95 – 120 – 150 – 240 – 300 mm².

The terminals have a rated connection capability, which is at least two stages smaller than the rated cross-section. The conductors may be solid, stranded or flexible and, if necessary, may have their ends pre-treated. The rated cross-section is verified using the gauges stipulated by VDE 0660 part 100 table 7 (see page W.14).

Rated current

Each rated cross-section is assigned a particular test current stipulated by VDE 0611-1. At these rated currents, terminals are not subject to non-permissible increases in temperature.

mm ²	1.5	2.5	4.0	6.0
A	17.5	24	32	41
mm ²	10	16	25	35
A	57	76	101	125
mm ²	50	70	95	120
A	150	192	232	269
mm ²	150	185	240	300
A	309	353	415	520

Rated voltage VDE 0611-1 / VDE 0660 part 100

The rated voltage of a terminal is the rated insulation voltage to which the insulation tests and creepage distances refer. It is defined analogously to DIN VDE 0110-1, and is one of the specifications marked on the terminal.

CE mark

Rated surge voltage DIN VDE 0110-1 / VDE 0660 part 100

Peak values of a surge voltage which can be applied to the terminals and to which the clearance distances acc. to VDE 0660 part 100 or DIN VDE 0110-1 refer.

Degree of soiling DIN VDE 0110-1 / VDE 0660 part 100

The degree of soiling stipulates the influence of solid, liquid or gaseous foreign particles, which may reduce the dielectric strength or specific surface resistance (see also page W.5).

Terminals for use in the industrial field of application are assigned degree of soiling 3: either conductive contamination may occur or, alternatively, dry, non-conductive contamination which becomes conductive in the likely event of condensation.

The minimum clearance distance is stipulated in combination with the rated surge voltage in VDE 0660 part 100 or DIN VDE 0110-1.

Operating conditions

Terminals can be operated under the following normal conditions:

- Ambient temperature – 5 °C ... +40 °C, mean temperature 24 h + 35 °C
- Altitude up to 2000 m a.s.l.
- Relative humidity 50% at + 40 °C, 90% at 20 °C.

CE mark

A EU directive stipulates that labelling with the CE mark is carried out by the manufacturer. The mark indicates to the state authorities that the item complies with the relevant directives. It thus guarantees free trade within Europe.

Conductor connectors from ≥ 50 V ~ / 75 V- comply with the basic safety requirements stated in the low-voltage directive 73/23/EEC (amended by 93/68/EEC).

CE marking acc. to the marking directive 93/68/EEC has been mandatory since 1 January 1997.

It is affixed to the packaging.

Declarations of conformity are kept available for inspection by the relevant national supervisory agencies as part of the technical documentation.

Terminals

Assembling terminal strips

Mounting and end brackets

- Terminal strips mounted from left to right
- Closed side on the left, open side on the right
- Open side of the terminal always closed using end plates or partition plates (WAP/TW; ZAP/TW and IAP)
- End brackets placed at the beginning and end of the terminal strip
- End bracket not required next to PE terminals. Exceptions: WDK/PE and ZPE



Combinations of different terminals

- End plates or partition plates (WAP/TW, ZAP/TW and IAP) must be used when the contour changes.
- For adjacent terminals with differing rated voltages, end plates or partition plates (WAP/TW, ZAP/TW and IAP) must be used in order that the respective rated voltages are adhered to.
- When the PE terminal is positioned next to or between corresponding feed-through terminals of the same series and size, this does not influence the rated voltage or rated surge voltage of the feed-through terminals.

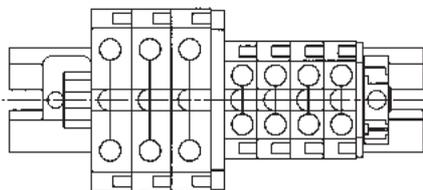

Dimensions

The overall dimensions of the terminals with fastening parts are stipulated, but without tolerances. A mounting tolerance of 0.2 mm must be added to the terminal width when planning projects.

Partition plate

The partition plate is necessary for visual separation of circuits or for electrical separation of neighbouring cross-connections.

Partition disc

Partition discs can be retrofitted between cross connectors or sockets in terminals up to a max. terminal width of 12 mm.

Compliance with the rated insulation voltage

The required stripping length for every Weidmüller product is stated in mm. These lengths, such as $< 6 \text{ mm} \pm 0.5 \text{ mm}$, $> 10 \text{ mm} \pm 1 \text{ mm}$, must be adhered to. This also applies when using ferrules.

The external dimensions of crimped ferrules must comply with IEC 60947-1 (1999 version).

Working on electrical connection elements with non-insulated screwdrivers

Work using non-insulated screwdrivers may only be carried out in disconnected systems.

The following five safety rules must be observed when disconnecting a system before beginning work and in order to ensure the system remains disconnected at the working site for the duration of this work:

- **Disconnect**
- **Secure to prevent the system from being switched on again**
- **Ascertain that the system is not live**
- **Earth and short circuit the system**
- **Cover or cordon off any neighbouring live parts**

These five rules constitute the safety precautions for working with electrical systems and equipment. The measures to be taken in accordance with operating and local conditions, e.g. for high- and low-voltage overhead lines, cables or switchgear, are stipulated in detail in VDE 0105 part 100.

Live terminals which are not in use

Any terminals which are not in use and which could carry live voltage are to be fitted with suitable covers (e.g. ADP 1...4) to prevent them from being inadvertently touched. The clamping screws of terminals, which are not in use, even those that are not live, are to be screwed tight.

VDE 0105 part 100

Operation of electrical installations: Work

Troubleshooting with two-pole voltage detectors including voltage tester acc. to IEC 61243-3.

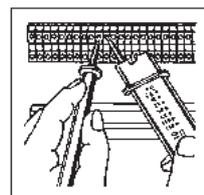

Connecting terminals

Two conductors in one terminal

The optimum solution in terms of allocating conductors to individual circuits and marking and organising individual functional units involves just one conductor being connected to each terminal.

If it is necessary to connect two conductors with the same cross-section in one terminal, then this may be carried out using W-series terminals (screw connection).

DIN IEC 60999-1 does not prohibit the use of twin ferrules for connecting two conductors in one terminal point using Z-series terminals (tension spring technology).

DIN IEC 60999-1 prohibits the use of screwless IDC terminals (I-series) for connecting two conductors.

• Continuous current for two conductors

The total current of two conductors must not exceed the continuous current of the terminal. The continuous current is the maximum current, which a terminal can carry without the increase in temperature exceeding 45 K.

• Rated insulation voltage

The rated insulation voltage of the terminal does not change when two conductors have been connected correctly.

Cross-connection systems

Weidmüller's WQV and ZQV cross-connectors are systems which are fully insulated and finger-safe in the event that they are directly (and inadvertently) touched; they are available with different numbers of poles (2-pole to 50-pole). Note: the rated voltage is always reduced when using cross-connections.

Cross-connections which have been cut off do not, however, offer this protection if the cut edge is directly (inadvertently) touched.

Partition plates or end plates must be used with these cross-connections to preserve the rated voltage.

Conductor connection with pressure clamp for large cross-sections

It is now no longer necessary to force conductors with large cross-sections into the terminal: they can be inserted simply and easily into the terminal block. All terminal types are available not only as individual terminals but also in block versions with three-, four- and five-pole blocks. All blocks are firmly screwed together to offer additional distortion resistance. Longitudinal holes in the bottom of the terminals allow for direct assembly.

Terminal blocks can be screwed directly to mounting plates with a 25 mm grid.

Other advantages include:

- constant transfer of forces with self-adjusting connection system
- any mounting direction possible
- finger-safe (VBG 4) even with cross-connection
- extremely distortion-proof

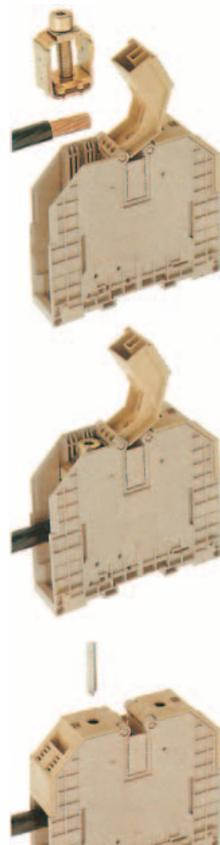

Open cover and remove screw unit

Insert conductor and replace screw unit

Close cover and tighten screw with Allen key

Torque ranges for clamping screws

Tightening the clamping screws in this torque range guarantees:

- secure, gas-proof clamping
- no mechanical destruction of the tension clamp
- voltage drop far below the required limit

The test torque acc. to IEC 60947-1 (supplemented by Annex C1 of IEC 60947-1-7 or the torque stated by the manufacturer) is the lower value of the torque range, at which all tests are successfully passed.

The upper value of the torque range is the maximum torque to be applied by the user.

The electric screwdriver should preferably be set to the middle torque of the clamping torque range.

The table gives the generally applicable values. Product-specific data are listed elsewhere for the respective products.

Products with head screw with slotted head

Thread	Torque range	
	Steel screws min. 8.8 [Nm]	A 2/A 4-80 [Nm]
M 2.5	0.4...0.8	0.4...0.8
M 3	0.5...1.0	0.5...1.0
M 3.5	0.8...1.6	0.8...1.6
M 4	1.2...2.4	...
M 5	2.0...4.0	...
M 6	2.5...5.0	...

Products with head screw with slotted head

Thread	Torque range	
	NE screws Cu 2 (CuZn) [Nm]	Cu 5 (CuNi 60) [Nm]
M 2.5	0.4...0.45	...
M 3	0.5...0.6	0.5...1.0
M 3.5	...	0.8...1.6
M 4	1.2...1.9	1.2...2.4
M 5	2.0...3.0	2.0...4.0
M 6	...	2.5...5.0

Products with head screw with hexagon

Thread	Torque range	
	Steel screws [Nm]	
M 4	1.2...2.4	
M 5	2.0...4.0	
M 6	3.0...6.0	
M 8	6.0...12	
M 10	10.0...20	
M 12	14.0...31	
M 16	25.0...60	

Terminals

Use of aluminium conductors

Weidmüller terminals are suitable for the direct connection of **solid round and sector-shaped aluminium conductors**.

Unlike copper, aluminium has certain material properties, which have to be taken into consideration when it is used as a conductor in electrical systems.

When exposed to air, the bare surface of the aluminium immediately becomes covered with a thin, non-conductive layer of oxide. This increases the contact resistance between the aluminium conductor and the busbar in the terminal. In the worst case, this may develop into a so-called glowing contact.

In the case of stranded conductors, this phenomenon is exacerbated by the contact resistance of the individual wires.

Despite these disadvantageous properties, aluminium conductors can be connected to Weidmüller terminals if the reduced rating currents for aluminium conductors and the following assembly instructions are observed:

1. Carefully clean the oxide layer from the stripped end of the conductor, for example using a knife.

Caution: do not use brushes, files or sandpaper, to which aluminium particles may adhere and be transferred to other conductors.

2. Immediately after removing the oxide layer, rub neutral grease – such as acid- and alkali-free Vaseline – into the end of the conductor and connect it directly to the terminal.

3. After disconnecting the conductor, repeat 1 and 2 prior to reconnection.

4. The instructions only apply to solid round or sector-shaped aluminium conductors.

solid round or sector-shaped

Terminal type	Rated cross- section	Reduced rated current when connecting an aluminium conductor	Thread size of terminal screw	Tightening torque
W-series	mm ²	„A“		Nm
WDU 2.5	2.5	20	M 2.5	0.5
WDU 4	4	27	M 3	0.6
WDU 6	6	35	M 3.5	1.2
WDU 10	10	48	M 4	2.0
WDU 16	16	64	M 5	3.0
WDU 35	35	105	M 6	4.0
WDU 70	70	163	M 8	10.0
WDU 120	120	230	M 10	15.0
SAK series				
SAK 2.5	2.5	20	M 2.5	0.5
SAK 4	4	27	M 3	0.6
SAK 6	6	35	M 3.5	1.2
SAK 10	10	48	M 4	2.0
SAK 16	16	64	M 4	2.0
SAK 35	35	105	M 6	4.0

stranded

Terminal type	Rated cross- section	Reduced rated current	Thread size of terminal screw	Tightening torque
W-series				
WFF 35	35	105	M 6	3.0
WFF 70	70	163	M 8	6.0
WFF 120	120	230	M 10	10.0
WFF 185	185	300	M 12	15.5
WFF 300	300	409	M 16	30.0

Tips during installation:

When tightening the terminals, it is advisable to hold up the conductor to avoid deformation to the mounting rail and to keep the foot of the terminal free of torsion forces.

Stranded aluminium conductors are connected to terminals using an aluminium cable lug selected according to its conductor shape and connected by following the instructions issued by the cable lug manufacturer.

Copper-plated aluminium washers are necessary for the transition from aluminium cable lugs to the busbar of the terminals. This is the only way to ensure reliable transition from copper to aluminium. The washers are fitted so that the copper side is in contact with the busbar and the aluminium side with the aluminium cable lug.

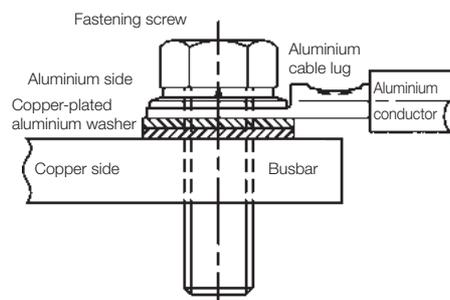

Terminals

Definition of the various types

PE terminals

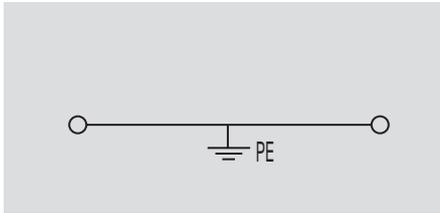

A PE terminal is a component with either one or several clamping positions for connecting and/or branching PE conductors (PE and PEN conductors) with a conductive connection to their support. Partially insulated PE terminals are insulated from adjacent live parts of terminals; the partial insulation is marked green/yellow.

Scope (IEC 60947-7-2)

This standard applies to PE terminals (with PE function) up to 120 mm² and to PE terminals (with PEN function) for sizes upwards of 10 mm² with screw clamping points or screwless clamping points for connecting round copper conductors with a cross-section between 0.2 mm² and 120 mm² (AWG 24/250 kcmil) for circuits up to 1000 Vac 1000 Hz or up to 1500 Vdc. PE terminals are used to produce the electrical and mechanical connection between copper conductors and the fastening base.

PEN function

Acc. to IEC 60947-7-2, only copper mounting rails may be used for application of the PEN function. Steel mounting rails must not be used.

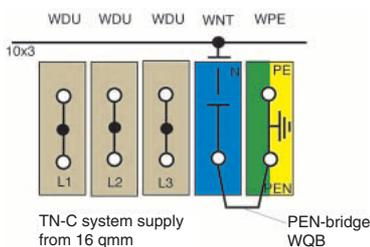

Use of TS 35 x 15

In order to comply with the current capability required by IEC 60947-7-2, the TS 35 x 15 mounting rail must be used for PE terminals with a rated cross-section of 16 mm² and upwards.

Fuse terminals

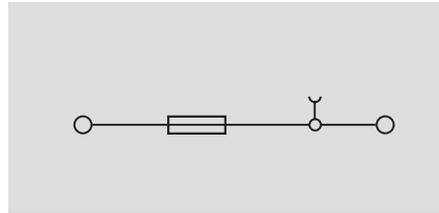

Fuse terminals consist of a terminal base and a fuse insert holder.

In the case of fuse terminals for low-voltage fuse inserts (D-system), the technical data are defined by IEC 60947-7-3 in conjunction with VDE 0636 part 301.

In the case of fuse terminals for device protection fuse inserts, the technical data are defined by standard IEC 60947-7-3 pertaining to the specific range of applications of these products.

Fuse terminals for device protection are rated for a certain maximum power loss on the basis of standard IEC 60127-2 valid for G-fuse inserts.

The product pages contain details about the maximum power loss for individual or composite arrangements for short-circuit and/or overload protection.

Multi-tier distribution terminals

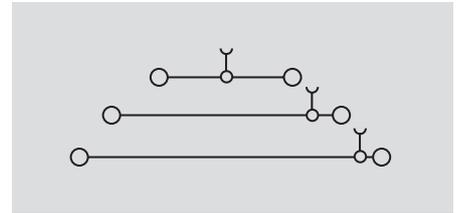

A multi-storey distribution terminal is a unit with clamping points for connecting and/or linking external, neutral and PE conductors to their fastening support with a conductive PE connection.

These terminals can be fitted on top of or next to each other and assembled to form terminal strips.

They have several connection levels, all of which are isolated from each other.

Scope IEC 60947-7-1 / IEC 60947-7-2 DIN VDE 0611-4 (partially)

These standards apply to multi-storey distributor terminals with clamping points and screw connections, and/or screwless connections for connecting or linking solid, stranded or flexible copper conductors. In distributor terminals, external conductor and/or N and PE conductor connections are all present together within a confined space.

The N-conductor can be divided for insulation measurement; it is not used for disconnecting or switching.

Terminals

Ex terminals

Confirmed according to the new European Ex-Directive 94/9/EC – ATEX –

Basic specifications

IEC 60947-7-1 (EN 60947-7-1/ VDE 0611P.1) and IEC 60947-7-2 (EN 60947-7-2/ VDE 0611P.3) are the basic specifications for terminals, and also protective conductor terminals. For use in potentially explosive atmospheres the following standards also apply: EN 50014 (IEC 60079-0/ VDE 0170/0171 P.1) and for increased safety "e" EN 50019 (IEC 60079-7/ VDE 0170/0171 P. 6). Ex terminals are so-called Ex-components according to EN 50014.

Components means any item essential to the safe functioning of equipment and protective systems, but with no autonomous function.

Components according to the Ex-directive 94/9/EC are not marked with CE.

Ex terminals are certified for the type of protection increased safety "e".

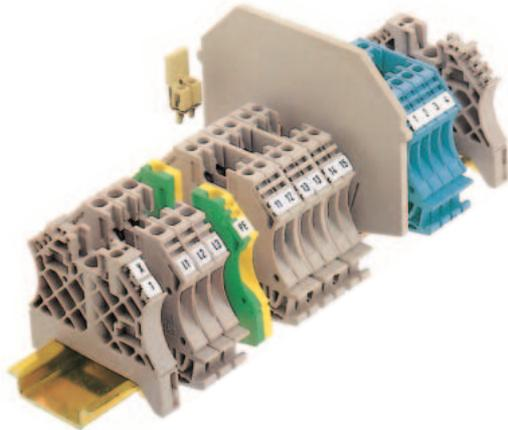
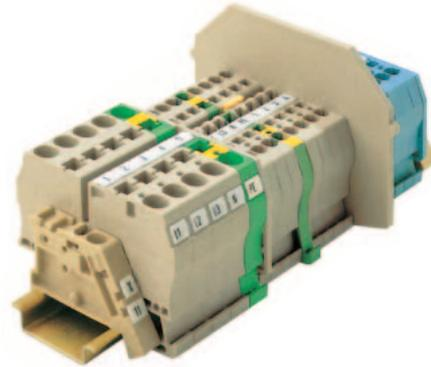

According to the directive 94/9/EC, the European notified bodies have been issuing EC-type examination certificates of the so-called ATEX-Generation since 1997 in accordance with EN 50014 / 50019 and the Ex directive 94/9/EC.

A prerequisite is a notification of the manufacturer's quality system. This exists for Weidmüller since 1997. Copies of these type examination certificates, the notification document and the declarations of conformity are available on request in electronic form.

The former component certifications (A to D generation) according to the Ex directive 76/117/EEC are still valid until 30/6/2003.

The clamping yoke, tension clamp and IDC clamping system of the terminals provide increased protection against self-release, and are so designed that conductor ends of flexible conductors do not have to be pre-prepared. The cross-sections and connection data specified in the selection tables are included in the certification.

Marking

Ex-RL94/9EG: Ⓜ II 2 G D

- Ⓜ Ex electrical equipment
- II 2 G Equipment group II category 2 (zone 1 electrical equipment)
- II 2 D Equipment group II category 2 (zone 21 electrical equipment)

- EN 50014/19:** EEx e II
- E Conformity with EN standards
- Ex Explosion protection
- e Increased safety
- II Equipment group

- KEMA 97ATEX4677U** (Example)
- KEMA Notified body
- ATEX Conformity with 94/9/EC
- U Component

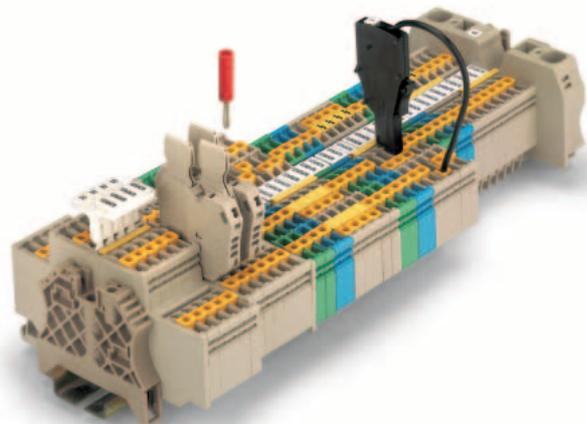

Terminals

Ex terminals

Confirmed according to the new
 European Ex-Directive 94/9/EC – ATEX –

Electrical data

The specified values of the current carrying capacity are related to an ambient temperature of 40 °C. At rated current load (+ 10%), the temperature of the currentbar of the terminal increases by a maximum of 40 K.

Recognizing an additional factor of safety according to EN 50 014, gives the following results:

Temperature class	Ambient temperature
T6, T5	– 50 °C to + 40 °C
T4 to T1	– 50 °C to + 55 °C

If the real ambient temperature is higher, the permitted operating current must be reduced accordingly. As defined in EN 50 014, the continuous operating temperature for Wemid and KrG is 100 °C, for PA material 80 °C.

Accessories

The accessories listed in the tables can be used, and are listed in the Ex certifications. To maintain the creepage and clearance distances for “e”, end plates or partitions should be used, as specified in the table.

Design for EEx i

Terminals for “i” intrinsically-safe circuits are passive components, whose temperature-rise behaviour and the electrical characteristics are known.

Therefore, there is no requirement for certification when being used in intrinsically-safe circuits.

The terminals are light blue to ensure clear identification and easy recognition.

These terminals conform to the construction type as terminals corresponding to the EEx e specifications.

Accessories

The accessories listed in the tables can be used and conform to EN 50 020 (IEC 60 079-11/VDE 0170/0171 P. 7).

Mounting

The general statements also apply here for EEx i applications. Additionally, the EEx i requirements always apply to the complete circuit, therefore also for parts in non-potentially explosive atmospheres.

Current carrying capacity of cables and conductors

Rated currents

Cross-section	VDE 0298 Part 4 (IEC364-5-523) Current carrying capacity of conductors		EN 50019 2 nd . edition Increased-safety type of protection connection terminals Ambient temperature 40 °C 40 K rise Current equivalent to connect conductor A
	Ambient temperature 30 °C Routing type C + 3 for PVC 70 °C conductors A	Ambient temperature 40 °C Factor 0.87 Routing type C + 3 for PVC 70 °C conductors A	
1.5	17.5	15.225	15
2.5	24	20.88	21
4	32	27.84	28
6	41	35.67	36
10	57	49.59	50
16	76	66.12	66
25	101	87.87	88
35	125	108.75	109
50	150	130.5	131
70	192	167.04	167
90	232	201.84	202
120	269	234.03	234
150	309	268.83	267
185	353	307.11	307
240	415	361.05	361
300	520	452.4	452

The current carrying capacity of cables and conductors in the installation is normally specified at 30 °C ambient temperature according to VDE 0298 Part 4. At 40 °C, the operating current shall be reduced by a factor of 0.87.

Clampability of 2 conductors in EExe

For our W-series terminals, it is fundamentally permitted to connect 2 wires to each clamping point. It is, however, necessary to use the next size down from the rated wire cross-section. For detailed information see section “Terminals”.

Terminals

ATEX cross-connection instructions

Arrangements of terminals and cross-connections

The maximum voltages for EEx e applications given below are determined on the basis of the terminals used, their cross-connection and which of the arrangements A-J is used.

A Continuous

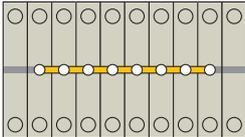

B Adjacent (To use with QWV)

Not separated by a partition plate or end plate

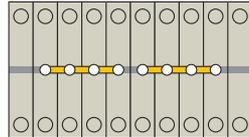

C Adjacent (To use with QV)

Separated by a partition plate or end plate

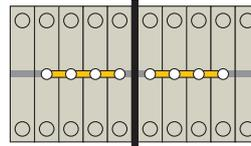

D Skipping

Bridging one or several not connected terminals (e.g. every third)

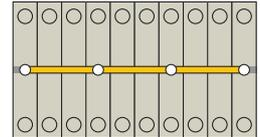

E Adjacent to a PE terminal (earth)

Without partition plate or end plate

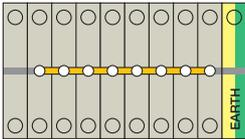

F Adjacent to a PE terminal (earth)

With partition plate or end plate

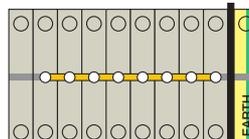

G Bridging a PE terminal (earth)

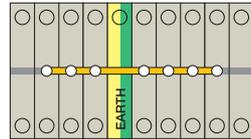

H 2 parallel cross-connections

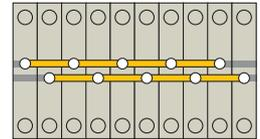

I 3 parallel cross-connections

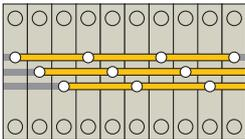

Maximum voltage

Family ¹⁾	Certificate no.	Rated voltage V	Rated current A	Nominal cross-section mm ²
AKZ ...				
AKZ 1.5	SIRA 02ATEX3001U	175	15	1.5
AKZ 2.5	SIRA 02ATEX3001U	175	21	2.5
AKZ 4	SIRA 02ATEX3001U	275	28	4.0
BK ...				
BK 2/E ... BK 12/E	SIRA 01ATEX3247U	275	28	4.0
I-series / IDK ...				
IDK 1.5N	KEMA 02ATEX2241 U	275	15	1.5
I-series / IDU ...				
IDU 1.5N	KEMA 02ATEX2241 U	275	15	1.5
IDU 2.5N	DEMKO 03ATEX134054 U	550	21	2.5
IDU 2.5N/ZF	DEMKO 03ATEX134054 U	550	21	2.5
IDU 2.5N/ZB	DEMKO 03ATEX134054 U	550	21	2.5
IDU 1.5 TE/E	KEMA 99ATEX4329 U	275	15	1.5
IDU 2.5 TE/E	KEMA 99ATEX4329 U	275	21	2.5
MK ...				
MK 3/.../E	SIRA 01ATEX3248U	275	21	2.5
MK 6/.../E	SIRA 01ATEX3249U	420	36	6.0

¹⁾ Please refer to the catalogue and the certificate showing precisely which article is approved.

Maximum voltage (V) (letters refer to the above diagrams)								
A	B	C	D	E	F	G	H	I
175	175	175	175	175	175	175	—	—
175	175	175	175	175	175	175	—	—
275	275	275	275	275	275	275	—	—
175	175	275	175	—	—	275	—	—
275	275	275	275	—	—	—	—	—
275	275	275	275	275	275	275	275	—
550	420	550	550	550	550	550	550	—
550	420	550	275	275	550	275	550	—
550	420	550	275	275	550	275	550	—
275	275	275	110	275	275	110	275	—
275	275	275	110	275	275	110	275	—
175	175	275	175	—	—	—	—	—
275	275	420	275	—	—	—	—	—

Terminals

Maximum voltage

Family 1)	Certificate no.	Rated voltage V	Rated current A	Rated cross-section mm ²
SAK-series				
SAK 2.5	KEMA 97ATEX1798 U	550	21	2.5
SAK 4	KEMA 97ATEX1798 U	550	28	4.0
SAK 6N	KEMA 97ATEX1798 U	550	36	6.0
SAK 10	KEMA 97ATEX1798 U	550	50	10.0
SAK 16	KEMA 97ATEX1798 U	750	66	16.0
SAK 35	KEMA 97ATEX1798 U	550	109	35.0
W-series / WDK ...				
WDK 1.5/R3.5	KEMA 99ATEX6545 U	275	15	1.5
WDK 2.5	KEMA 98ATEX1687 U	275	21	2.5
WDK 2.5N	KEMA 00ATEX2061U	550	21	2.5
WDK 4N	KEMA 00ATEX2061U	550	28	4.0
W-series / WDU ...				
WDU 1.5/ZZ	KEMA 98ATEX1685 U	550	14	1.5
WDU 2.5/1.5/ZR	KEMA 98ATEX1685 U	550	15	1.5
WDU 2.5/TC	SIRA 02ATEX3153 U	50	15	1.5
WDU 1.5/R3.5	KEMA 99ATEX6545 U	275	1	2.5
WDU 2.5N	KEMA 98ATEX1683 U	420	21	2.5
WDU 2.5	KEMA 98ATEX1683 U	550	21	2.5
WDU 4	KEMA 98ATEX1683 U	750	28	4.0
WDU 6	KEMA 98ATEX1683 U	550	36	6.0
WDU 10	KEMA 98ATEX1683 U	550	50	10.0
WDU 16	KEMA 98ATEX1683 U	750	66	16.0
WDU 35	KEMA 98ATEX1683 U	750	109	35
WDU 70N/35	KEMA 98ATEX1683 U	750	167	70
WDU 70/95	KEMA 98ATEX1686 U	750	202	70
WDU 120/150	KEMA 98ATEX1686 U	1100	234	120
WDU 240	KEMA 01ATEX2186 U	750	300	240
WDU 4 SL	SIRA 02ATEX3242 U	275	28	4
WDU 6 SL	SIRA 02ATEX3242 U	275	36	6
WDU 10 SL	SIRA 02ATEX3242 U	275	50	10
Stud terminals / WFF ...				
WFF 35	KEMA 98ATEX1684 U	1100	109	35
WFF 70	KEMA 98ATEX1684 U	1100	167	70
WFF 120	KEMA 98ATEX1684 U	1100	234	120
WFF 185	KEMA 98ATEX1684 U	1100	307	185
WFF 300	KEMA 98ATEX1684 U	1100	452	300
Z-series / ZDK ...				
ZDK 2.5/1.5	KEMA 97ATEX4677 U	275	18	2.5
Z-series / ZDU ...				
ZDU 1.5	KEMA 01ATEX2106 U	550	15	1.5
ZDU 1.5/3AN	KEMA 01ATEX2106 U	550	15	1.5
ZDU 1.5/4AN	KEMA 01ATEX2106 U	550	15	1.5
ZDU 2.5	KEMA 97ATEX2521 U	550	21	2.5
ZDU 2.5/2X2AN	KEMA 97ATEX2521 U	550	21	2.5
ZDU 2.5/3AN	KEMA 97ATEX2521 U	550	21	2.5
ZDU 2.5/4AN	KEMA 97ATEX2521 U	550	21	2.5
ZDU 4	KEMA 97ATEX2521 U	550	28	4
ZDU 6	KEMA 97ATEX2521 U	550	36	6
ZDU 6/3AN	KEMA 00ATEX2107 U	550	36	6
ZDU 10	KEMA 99ATEX5514 U	550	50	10
ZDU 10/3AN	KEMA 00ATEX2107 U	550	50	10
ZDU 16	KEMA 99ATEX5514 U	550	66	16
ZDU 16/3AN	KEMA 00ATEX2107 U	550	66	16
ZDU 35	KEMA 00ATEX2107 U	750	109	35
ZDU 2.5-2/3AN	KEMA 97ATEX4677 U	550	21	2.5
ZDU 2.5-2/4AN	KEMA 97ATEX4677 U	550	21	2.5
ZDUA 2.5-2	KEMA 97ATEX4678 U	275	20	2.5
ZDUB 2.5-2/...	KEMA 97ATEX2755 U	550	21	2.5

¹⁾ Please refer to the catalogue and the certificate showing precisely which article is approved.

Maximum voltage (V) (letters refer to the above diagrams)								
A	B	C	D	E	F	G	H	I
550	550	550	175	550	550	175	—	—
550	550	550	175	550	550	175	—	—
550	550	550	175	550	550	175	—	—
550	550	550	175	550	550	175	—	—
550	550	550	175	550	750	175	—	—
550	550	550	175	550	550	175	—	—
175	175	275	175	175	—	—	—	—
275	275	275	60	275	275	60	—	—
550	550	550	275	550	550	275	—	—
550	550	550	275	550	550	275	—	—
550	550	550	110	550	550	110	110	—
550	550	550	110	550	550	110	110	—
—	—	—	—	—	—	—	—	—
175	175	275	175	175	—	—	—	—
420	420	420	110	420	420	110	—	—
550	550	550	110	420	550	110	110 ²⁾	60 ³⁾
750	750	750	110	420	750	110	—	—
550	550	550	110	420	550	110	—	—
550	550	550	110	420	550	110	—	—
750	750	750	110	750	750	110	—	—
750	750	750	110	750	750	110	—	—
750	750	750	—	750	750	—	—	—
750	750	750	—	750	750	—	—	—
1100	1100	1100	—	1100	1100	—	—	—
—	—	—	—	—	—	—	—	—
275	275	275	175	275	275	175	175	—
275	275	275	175	275	275	175	175	—
275	275	275	175	275	275	175	175	—
1100	1100	1100	—	1100	1100	—	—	—
1100	1100	1100	—	1100	1100	—	—	—
1100	1100	1100	—	1100	1100	—	—	—
1100	1100	1100	—	1100	1100	—	—	—
275	275	275	275	275	275	275	—	—
275	275	275	175	275	550	175	275	—
275	275	275	175	275	550	175	275	—
275	275	275	275	275	275	275	275	—
—	—	—	—	—	—	—	—	—
275	275	275	275	275	275	275	—	—
275	275	275	275	275	275	275	—	—
275	275	275	275	275	275	275	—	—
275	275	275	275	275	275	275	—	—
550	550	550	—	550	550	—	—	—
550	550	550	275	550	550	—	—	—
550	550	550	—	550	550	—	—	—
—	—	—	—	—	—	—	—	—
550	550	550	—	550	750	—	—	—
420	420	420	275	550	550	275	110	—
—	—	—	—	—	—	—	—	—
275	275	275	110	275	275	110	—	—
—	—	—	—	—	—	—	—	—

²⁾ For ZQV, the outer channels must be used in these cases.

³⁾ Only possible with ZQV.

Index

Type Index	X.2 - X.11
Order Number Index	X.12 - X.23

The whole world of connection-technology in three catalogues

	X.24 - X.25
--	-------------

Worldwide activities

Addresses abroad	X.26 - X.27
------------------	-------------

Type	Order No.	EAN-No.	Page	Type	Order No.	EAN-No.	Page	Type	Order No.	EAN-No.	Page
A											
AD 250	0634100000	4008190083199	1.18	AP AST3+4 KRG	0298120000	4008190172213	1.4	AP SAKK4+10 KER/WWS	9502630000	4008190047290	1.6
AD 3 SAK10	0178500000	4008190007591	1.17	AP AST3+4 KRG	0298120000	4008190172213	1.6	AP SAKR BE	0211360000	4008190184834	1.6
AD 3 SAK16	0297900000	4008190080884	1.17	AP AST3+4/35 GE	2077060000	4032248424757	1.6	AP SAKR BE	0211360000	4008190184834	E.3
AD 3 SAK2.5	0273400000	4008190106027	1.17	AP ATA1	2093550000		1.6	AP SAKR BE	0211360000	4008190184834	1.4
AD 3 SAK35	0297900000	4008190038229	1.17	AP DK4	0359260000	4008190012991	1.6	AP SAKR BE RS-SET	1820200000	4032248313334	1.6
AD 3 SAK4	0297600000	4008190173395	1.17	AP DK4 BL	0359280000	4008190031213	1.6	AP SAKR BL	0211380000	4008190141943	1.6
AD 3 SAK6N	0297700000	4008190086787	1.17	AP DK4/380 Q	0438560000	4008190133351	1.6	AP SAKR KRG	0211320000	4008190126704	1.6
AD 3 SAK70	0344300000	4008190166489	1.17	AP DK4/380 Q	0438560000	4008190133351	1.4	AP SAKS1+3 KRG	0191320000	4008190031688	1.6
AD 3 WSD SAKG54 HP/DBR	0264900000	4008190144333	1.17	AP DK4Q	1397160000	4008190125899	B.34	AP SAKS1+3 KRG	0191320000	4008190031688	1.4
AD 4 AKZ4	0303400000	4008190068158	1.17	AP DK4Q	1397160000	4008190125899	A.34	AP SAKS1+3 KRG	0191320000	4008190031688	B.27
AD 4 SAK10	0178600000	4008190068288	1.17	AP DK4Q BL	1397160000	4008190125899	1.6	AP SAKS1+3 KRG/DB	0191300000	4008190099763	1.6
AD 4 SAK16	0518200000	4008190122416	1.17	AP DK4S	1397180000	4008190171728	1.6	AP SAKT2 KRG	0329120000	4008190012793	1.6
AD 4 SAK35	0178700000	4008190056414	1.17	AP DK4S BL	0631380000	4008190103299	1.6	AP SAKT2 KRG	0329120000	4008190012793	1.4
AD 4 SAK35N	0576700000	4008190119881	1.17	AP DKIT4	0635060000	4008190012168	1.6	AP SAKT4 KRG	0244920000	4008190108953	1.6
AD 4 SAK4	0285300000	4008190072902	1.17	AP DKT4 PA	0687560000	4008190009465	1.6	AP ST5 PA/BE	0447260000	4032248183913	1.6
AD 4 SAK6N	0196600000	4008190169336	1.17	AP DL2.5	1317660000	4008190180508	1.6	AP ST5 PPO/SW	0447240000	4008190457044	1.6
AD 4 WSD SAKG28 HP/DBR	0263100000	4008190020477	1.17	AP DL2.5 BL	1317680000	4008190400545	1.6	AP STA2.5 0.5MM	2012770000	4008190236823	1.6
AD 4 WSD SAKG32 HP/DBR	0283100000	4008190087982	1.17	AP DL2.5 DB	1784210000	4032248189878	1.6	AP TAL	0212260000	4008190104740	1.6
AD 4 WSD SAKG40 HP/DBR	0263200000	4008190152802	1.17	AP DL2.5 PE	1599960000	4008190164324	1.6	AP TOP2.5T-AST6T	0582560000		1.4
AD 4 WSD SAKG46 HP/DBR	0263300000	4008190175528	1.17	AP DL2.5/PE	1599960000	4008190164324	1.6	AP TOP4SF-FF	0483460000	4008190081614	1.6
AD 4 WSD SAKG54 HP/DBR	0261100000	4008190070779	1.17	AP DL2.5/PE DB	1783800000	4032248189830	1.6	AP TOP4SF-FF	0483460000	4008190081614	1.4
ADK 1/1.5	0303860000	4008190035723	E.11	AP DL2.5	1313260000	4008190055028	1.6	AP TW/S.../35	1333200000	4008190188016	1.6
ADK 1/1.5 BL	0303880000	4008190168315	E.11	AP DL2.5 DB	1783550000	4032248189847	1.6	AP VL1.5	1633260000	4008190257729	1.6
ADL	0210800000	4008190062774	1.18	AP DSK1.5	0532960000	4008190093358	1.6	AP VL1.5 DB	1784150000	4032248190140	1.6
ADP 1/HP1 1M	0485200000	4008190043568	1.16	AP DUSA4/35	0401360000	4008190120986	1.6	AP VLH.5/PE	1633320000	4008190257774	1.6
ADP 2/HP2 1M	0485300000	4008190051716	1.16	AP KDKS1 1.5	9503330000	4008190124212	1.6	AP VLH.5/PE DB	1784160000	4032248190157	1.6
ADP 3/HP3 1M	0485400000	4008190023928	1.16	AP KDKS1 1.5 DB	9532470000	4032248039227	1.6	ASK 1/15	0376860000	4008190141202	E.7
ADP 4/1000	1430760000	4008190132897	1.16	AP KDKS1 EN	9503340000	4008190157630	1.6	ASK 1/EN	0474560000	4008190020880	C.5
ADP 4/300	1378160000	4008190183851	1.16	AP KSKM	9509630000	4008190456771	1.6	ASK 1/EN LD 120K 230VDC	0225660000	4008190084890	C.5
AH 28 SAKG28	0326660000	4008190031510	1.17	AP MAK2.5	1615280000	4008190193850	1.6	ASK 1/EN LD 15K 24VDC	0222760000	4008190024789	C.5
AH 32 SAKG32	0326760000	4008190064976	1.17	AP MAK2.5 DB	7917000000	4032248190911	1.6	ASK 1/EN LD 1D 115VAC	0225560000	4008190163419	C.5
AH 40 SAKG40	0326860000	4008190061258	1.17	AP OSC 10/16	9154850000	4008190899011	1.6	ASK 1/EN LD 1D 230VAC	0225760000	4008190126773	C.5
AH 46 SAKG46	0326960000	4008190174712	1.17	AP OSC 4	9154860000	4008190899004	1.6	ASK 1/EN LD 1D 24VAC	0222860000	4008190029872	C.5
AK 95	0364200000	4008190164225	H.3	AP PPT/35	3835120000	4008190003364	1.6	ASK 1/EN LD 1D 48VAC	0225360000	4008190136277	C.5
AKA 2.5	0300720000	4008190072018	E.13	AP RSF1 KRG	0270420000	4008190099107	1.6	ASK 1/EN LD 27K 48VDC	0225260000	4008190185022	C.5
AKA 2.5 BL	0300770000	4008190084547	E.13	AP RSF2 KRG	0301420000	4008190168537	1.6	ASK 1/EN LD 33K 60VDC	0226460000	4008190148591	C.5
AKE 2.5	1303360000	4008190084950	E.4	AP RSF3	0270460000	4008190110635	1.6	ASK 1/EN LD 56K 115VDC	0225460000	4008190136894	C.5
AKE 4	0380260000	4008190056841	E.5	AP RV	4145220000	4008190401528	1.6	AST 1 6.3	0266360000	4008190143411	B.36
AKE 4 MS	0211200000	4008190074906	E.4	AP SAK16	0271160000	4008190120429	1.4	AST 1 6.3 KRG	0266320000	4008190167941	B.44
AKZ 1.5	0340460000	4008190091576	E.2	AP SAK16 BL	0271160000	4008190120429	1.6	AST 1 6.3/2.8	0478260000	4008190003043	B.36
AKZ 1.5 BL	0340480000	4008190075378	E.2	AP SAK16 GE	0271180000	4008190169800	1.6	AST 1 6.3/2.8 KRG	0478220000	4008190140625	B.44
AKZ 1.5 SW 1X1	0357960000	4008190155544	E.14	AP SAK16 KRG	0271120000	4008190062606	1.6	AST 1/35 6.3	0664860000	4008190103279	A.36
AKZ 1.5L VS	0340160000	4008190156350	E.10	AP SAK16 KRG BL	0271120000	4008190062606	1.6	AST 1/35 6.3/2.8	0699660000	4008190041861	A.36
AKZ 2.5	0697160000	4008190121716	E.2	AP SAK2.5	0279560000	4008190075736	B.34	AST 3 6.3	0236760000	4008190177935	B.36
AKZ 2.5 BL	0697180000	4008190167448	E.2	AP SAK2.5 BL	0279580000	4008190050702	1.6	AST 3 6.3 KRG	0298020000	4008190156831	B.44
AKZ 2.5 K SW U/V 1X1	0108960000	4008190020934	E.15	AP SAK2.5 GE	0279500000	4008190404110	1.6	AST 3 6.3/2.8 KRG/BL	0442470000	4008190002923	B.44
AKZ 4	0294360000	4008190054625	E.3	AP SAK2.5 KRG	0279520000	4008190014137	1.6	AST 3/35 6.3	0479360000	4008190132941	A.36
AKZ 4 BL	0294380000	4008190021652	E.3	AP SAK2.5 KRG BL	0279520000	4008190014117	1.4	AST 3/35 6.3/2.8	0460360000	4008190001094	A.36
AKZ 4 LD 24VDC	0822520000	4032248095456	E.6	AP SAK2.5 KRS	0279570000	4008190022525	1.6	AST 4 SF 6.3 KRG	0321220000	4008190167646	B.45
AKZ 4 LL VS	0346460000	4008190009526	E.11	AP SAK2.5 OR	0279530000	4008190025755	1.4	AST 4 SF 6.3/2.8 KRG	0439120000	4008190005146	B.45
AKZ 4 S WA 2X2.8	0324460000	4008190132545	E.9	AP SAK2.5 OR	0279540000	4008190000073	1.6	AST 4/35 SF 6.3/2.8	0460460000	4008190061319	A.37
AKZ 4 SF SE 6.3/2.8	0158760000	4008190017606	E.9	AP SAK2.5/35	2144900000	4008190241797	1.6	AST 5 SF 6.3	0334560000	4008190051587	B.37
AKZ 4 SS SE 6.3/2.8	0324560000	4008190125301	E.8	AP SAK2.5/35 + AST3+4	0460560000	4008190048334	1.6	AST 5 SF 6.3 KRG	0334520000	4008190043247	B.45
AKZ 4 SW WA 2X2.8	0362460000	4008190005917	E.8	AP SAK2.5/35 BL	0460580000	4008190081164	1.6	AST 5 SF 6.3/2.8	0479260000	4008190084866	B.37
AKZ 4 SS 1X1	0445860000	4008190021733	E.14	AP SAK2.5/35 DB	0460490000	4008190394868	1.6	AST 5 SF 6.3/2.8 KRG	0479220000	4008190021795	B.45
AKZ 4L SL VS	0334860000	4008190019501	E.10	AP SAK2.5L KRG	0309220000	4008190049997	1.6	AST 5/35 6.3	0699760000	4008190133757	A.37
AKZ 4L SL VS BL	0334880000	4008190158156	E.10	AP SAK2.5L KRG BL	0309220000	4008190124878	1.6	AST 5/35 SF 6.3/2.8	0664960000	4008190043322	A.37
AKZ 4L SL VS KRG	0334820000	4008190011666	E.12	AP SAK3.5 KRG	0303620000	4008190050184	1.6				
AL 1	0137320000	4008190023454	E.12	AP SAK3.5 KRG BL	0303620000	4008190050184	1.4	B			
AP DK4Q DB	0631300000	40081900965013	1.6	AP SAK35 KRG/BL	0303670000	4008190009113	1.6	BEZ.-KARTE ADP	0566700000	4008190000127	I.16
AP 100 GR	1773410000	4032248141111	1.6	AP SAK35/TW SAK16	0303660000	4008190110765	1.6	BFEH 1/WSH	1082400000	4008190898057	G.7
AP 110 GR	1990080000	4032248214105	1.6	AP SAK35/TW SAK16 BL	0303660000	4008190110765	1.6	BFSC M2.5X18 PA/RT	0303300000	4008190040673	I.17
AP 2 DSG1.5T	2119490000	4008190219017	1.6	AP SAK35/TW SAK16 BL GE	0303680000	4008190025199	1.6	BFSC M3X22 PA/RT	0128900000	4008190084158	I.17
AP 70 SAK70 KRG	0340920000	4008190154684	1.4	AP SAK4 KRG M.FU	0460020000	4008190130206	1.6	BFSC M3X25	0292500000	4008190177027	I.10
AP 70 SAK70 KRG	0340920000	4008190154684	1.6	AP SAK4-10	0117960000	4008190081485	1.6	BFSC M3X30	0292600000	4008190177027	I.10
AP ADK1	0476260000	4008190158194	1.6	AP SAK4-10 BL	0117980000	4008190171087	1.6	BFSC M3X35	0309800000	4008190058838	I.10
AP AK2.5	0162520000	4008190139179	1.6	AP SAK4-10 DB	0105100000	4008190394875	1.6	BFSC M3X30	0292500000	4008190177027	I.10
AP AK2.5 KRG/BL	0162570000	4008190022358	1.6	AP SAK4-10							

Type	Order No.	EAN-No.	Page	Type	Order No.	EAN-No.	Page	Type	Order No.	EAN-No.	Page
BS 25 I/HV SAKT1	0335800000	4008190039196	I.21	DEK 5 FW X9-Z9	0133261158	4008190094577	K.20	DEK 5 GW 138	0522660138	4008190084066	K.20
BS 25 O/H SAKT1	0334700000	4008190118839	I.21	DEK 5 FWZ 1,3,5-19	0235860000	4008190066420	K.20	DEK 5 GW 139	0522660139	4008190028053	K.20
BS 35I/WSH 2	1760720000	4008190068714	G.7	DEK 5 FWZ 1-10	0523060001	4008190021726	K.20	DEK 5 GW 14	0522660014	4008190177706	K.20
BS 35II KLBU HOLDER	1723800000	4008190377038	G.10	DEK 5 FWZ 1-9	1572000000	4008190177164	K.20	DEK 5 GW 140	0522660140	4008190164966	K.20
BS 35II KLBU2X3-8/2X2-6	1768020000	4032248109296	G.10	DEK 5 FWZ 11-20	0523060011	4008190112219	K.20	DEK 5 GW 141	0522660141	4008190035082	K.20
BS 35II KLBU3-8	1723810000	4008190377026	G.10	DEK 5 FWZ 2,4,6-20	0236160000	4008190028664	K.20	DEK 5 GW 142	0522660142	4008190059361	K.20
BS 35II KLBU3-8/2X2-6	1749430000	4032248013210	G.10	DEK 5 FWZ 21,23,25-39	0235960000	4008190115326	K.20	DEK 5 GW 143	0522660143	4008190082796	K.20
BS 35II/KLBU 4-13.5	1723820000	4008190377014	G.10	DEK 5 FWZ 21-30	0523060021	4008190129897	K.20	DEK 5 GW 144	0522660144	4008190033880	K.20
BST 2 BEZEICHNUNGSSTR.	1287700000	4008190132392	I.17	DEK 5 FWZ 22.24,26-40	0236260000	4008190185473	K.20	DEK 5 GW 145	0522660145	4008190139957	K.20
BTWZ KLBU	1742630000	4008190980764	G.8	DEK 5 FWZ 31-40	0523060031	4008190074678	K.20	DEK 5 GW 146	0522660146	4008190053567	K.20
BZT 1 WS 10/5	1805490000	4032248270231	K.14	DEK 5 FWZ 41,43,45-59	0236060000	4008190144081	K.20	DEK 5 GW 147	0522660147	4008190086572	K.20
BZT 1 ZA WS10/5	1805520000	4032248270248	K.14	DEK 5 FWZ 41-50	0523060041	4008190172480	K.20	DEK 5 GW 148	0522660148	4008190082406	K.20
BZT 2 WS 10/5	1805480000	4032248270224	K.14	DEK 5 FWZ 42,44,46-60	0236360000	4008190116118	K.20	DEK 5 GW 149	0522660149	4008190042134	K.20
BZT 2 ZA WS 10/5	1805530000	4032248270255	K.14	DEK 5 FWZ 51-60	0523060051	4008190162436	K.20	DEK 5 GW 15	0522660015	4008190081997	K.20
				DEK 5 FWZ 61-70	0523060061	4008190079482	K.20	DEK 5 GW 150	0522660150	4008190155353	K.20
				DEK 5 FWZ 71-80	0523060071	4008190114589	K.20	DEK 5 GW 151	0522660151	4008190040840	K.20
				DEK 5 FWZ 81-90	0523060081	4008190075873	K.20	DEK 5 GW 152	0522660152	4008190116897	K.20
				DEK 5 FWZ 91-100	0523060091	4008190000653	K.20	DEK 5 GW 153	0522660153	4008190120443	K.20
CleanUnit PrintJet II	1858950000	4032248410668	K.19	DEK 5 FWZ L1-EIK	0354361203	4008190042257	K.20	DEK 5 GW 154	0522660154	4008190087456	K.20
CTI 6	9006120000	4008190044527	J.8	DEK 5 FWZ L1-PE	0354361187	4008190047054	K.20	DEK 5 GW 155	0522660155	4008190017941	K.20
CTI 6 S	9006210000	4008190166694	J.8	DEK 5 FWZ U,V,W,N,PE	0558360000	4008190075217	K.20	DEK 5 GW 156	0522660156	4008190138653	K.20
				DEK 5 GE NEUTRAL	0473391687	4008190131586	K.20	DEK 5 GW 157	0522660157	4008190186012	K.20
				DEK 5 GN NEUTRAL	0473391688	4008190057473	K.20	DEK 5 GW 158	0522660158	4008190008291	K.20
				DEK 5 GR NEUTRAL	0473391691	4008190165079	K.20	DEK 5 GW 159	0522660159	4008190019457	K.20
				DEK 5 GS A	0132961021	4008190078904	K.20	DEK 5 GW 16	0522660016	4008190175252	K.20
				DEK 5 GS B	0132961022	4008190121631	K.20	DEK 5 GW 160	0522660160	4008190071868	K.20
				DEK 5 GS C	0132961023	4008190162221	K.20	DEK 5 GW 161	0522660161	4008190163846	K.20
				DEK 5 GS D	0132961024	4008190131876	K.20	DEK 5 GW 162	0522660162	4008190064938	K.20
				DEK 5 GS E	0132961025	4008190064402	K.20	DEK 5 GW 163	0522660163	4008190084448	K.20
				DEK 5 GS ERDE	0157261202	4008190145774	K.20	DEK 5 GW 164	0522660164	4008190067182	K.20
				DEK 5 GS ERDE IM KREIS	0157261203	4008190046415	K.20	DEK 5 GW 165	0522660165	4008190049133	K.20
				DEK 5 GS F	0132961026	4008190186357	K.20	DEK 5 GW 166	0522660166	4008190150471	K.20
				DEK 5 GS G	0132961027	4008190046910	K.20	DEK 5 GW 167	0522660167	4008190023959	K.20
				DEK 5 GS H	0132961028	4008190061142	K.20	DEK 5 GW 168	0522660168	4008190087548	K.20
				DEK 5 GS I	0132961029	4008190074494	K.20	DEK 5 GW 169	0522660169	4008190078256	K.20
				DEK 5 GS J	0132961030	4008190080473	K.20	DEK 5 GW 17	0522660017	4008190008952	K.20
				DEK 5 GS K	0132961031	4008190177669	K.20	DEK 5 GW 170	0522660170	4008190107048	K.20
				DEK 5 GS L	0132961032	4008190081003	K.20	DEK 5 GW 171	0522660171	4008190059729	K.20
				DEK 5 GS M	0132961033	4008190102821	K.20	DEK 5 GW 172	0522660172	4008190131371	K.20
				DEK 5 GS MP	0157261235	4008190126335	K.20	DEK 5 GW 173	0522660173	4008190165895	K.20
				DEK 5 GS N	0132961034	4008190087883	K.20	DEK 5 GW 174	0522660174	4008190102243	K.20
				DEK 5 GS O	0132961035	4008190071691	K.20	DEK 5 GW 175	0522660175	4008190162829	K.20
				DEK 5 GS P	0132961036	4008190173937	K.20	DEK 5 GW 176	0522660176	4008190089269	K.20
				DEK 5 GS PE	0157261187	4008190064471	K.20	DEK 5 GW 177	0522660177	4008190014308	K.20
				DEK 5 GS Q	0132961037	4008190050122	K.20	DEK 5 GW 178	0522660178	4008190057718	K.20
				DEK 5 GS R	0132961038	4008190080105	K.20	DEK 5 GW 179	0522660179	4008190064969	K.20
				DEK 5 GS S	0132961039	4008190109882	K.20	DEK 5 GW 18	0522660018	4008190181888	K.20
				DEK 5 GS T	0132961040	4008190094546	K.20	DEK 5 GW 180	0522660180	4008190104313	K.20
				DEK 5 GS U	0132961041	4008190049164	K.20	DEK 5 GW 181	0522660181	4008190037086	K.20
				DEK 5 GS V	0132961042	4008190123604	K.20	DEK 5 GW 182	0522660182	4008190125196	K.20
				DEK 5 GS W	0132961043	4008190160234	K.20	DEK 5 GW 183	0522660183	4008190020897	K.20
				DEK 5 GS X	0132961044	4008190161057	K.20	DEK 5 GW 184	0522660184	4008190035044	K.20
				DEK 5 GS Y	0132961045	4008190161125	K.20	DEK 5 GW 185	0522660185	4008190013493	K.20
				DEK 5 GS Z	0132961046	4008190089375	K.20	DEK 5 GW 186	0522660186	4008190146061	K.20
				DEK 5 GW	0576260000	4008190163297	K.20	DEK 5 GW 187	0522660187	4008190087036	K.20
				DEK 5 GW +	0576261198	4008190429072	K.20	DEK 5 GW 188	0522660188	4008190146559	K.20
				DEK 5 GW -	0576261199	4008190429058	K.20	DEK 5 GW 189	0522660189	4008190168711	K.20
				DEK 5 GW 1	0522660001	4008190122393	K.20	DEK 5 GW 19	0522660019	4008190131357	K.20
				DEK 5 GW 10	0522660010	4008190162788	K.20	DEK 5 GW 190	0522660190	4008190182939	K.20
				DEK 5 GW 100	0522660100	4008190014124	K.20	DEK 5 GW 191	0522660191	4008190132910	K.20
				DEK 5 GW 101	0522660101	4008190011451	K.20	DEK 5 GW 192	0522660192	4008190045258	K.20
				DEK 5 GW 102	0522660102	4008190162474	K.20	DEK 5 GW 193	0522660193	4008190148034	K.20
				DEK 5 GW 103	0522660103	4008190123314	K.20	DEK 5 GW 194	0522660194	4008190177553	K.20
				DEK 5 GW 104	0522660104	4008190010973	K.20	DEK 5 GW 195	0522660195	4008190171650	K.20
				DEK 5 GW 105	0522660105	4008190052805	K.20	DEK 5 GW 196	0522660196	4008190164799	K.20
				DEK 5 GW 106	0522660106	4008190094799	K.20	DEK 5 GW 197	0522660197	4008190086671	K.20
				DEK 5 GW 107	0522660107	4008190063658	K.20	DEK 5 GW 198	0522660198	4008190161446	K.20
				DEK 5 GW 108	0522660108	4008190186661	K.20	DEK 5 GW 199	0522660199	4008190045500	K.20
				DEK 5 GW 109	0522660109	4008190083953	K.20	DEK 5 GW 2	0522660002	4008190119843	K.20
				DEK 5 GW 11	0522660011	4008190022051	K.20	DEK 5 GW 20	0522660020	4008190164492	K.20
				DEK 5 GW 110	0522660110	4008190104825	K.20	DEK 5 GW 200	0522660200	4008190057329	K.20
				DEK 5 GW 111	0522660111	4008190118082	K.20	DEK 5 GW 21	0522660021	4008190039660	K.20
				DEK 5 GW 112	0522660112	4008190130022	K.20	DEK 5 GW 22	0522660022	4008190104405	K.20
				DEK 5 GW 113	0522660113	4008190070120	K.20	DEK 5 GW 23	0522660023	4008190097035	K.20
				DEK 5 GW 114	0522660114	4008190164263	K.20	DEK 5 GW 24	0522660024	4008190052478	K.20
				DEK 5 GW 115	0522660115	4008190067694	K.20	DEK 5 GW 25	0522660025	4008190008277	K.20
				DEK 5 GW 116	0522660116	4008190089498	K.20	DEK 5 GW 26	0522660026	4008190081805	K.20
				DEK 5 GW 117	0522660117	4008190074517	K.20	DEK 5 GW 27	0522660027	4008190119904	K.20
				DEK 5 GW 118	0522660118	4008190023423	K.20	DEK 5 GW 28	0522660028	4008190120719	K.20
				DEK 5 GW 119	0522660119	4008190161620	K.20	DEK 5 GW 29	0522660029	4008190120924	K.20
				DEK 5 GW 12	0522660012	4008190034764	K.20	DEK 5 GW 3	0522660003	4008190116101	K.20
				DEK 5 GW 120	0522660120	4008190122720	K.20	DEK 5 GW 30	0522660030	4008190094232	K.20
				DEK 5 GW 121	0522660121	4008190186135	K.20	DEK 5 GW 31	0522660031	4008190020347	K.20
				DEK 5 GW 122	0522660122	4008190178680	K.20	DEK 5 GW 32	0522660032	4008190064389	K.20
				DEK 5 GW 123	0522660123	4008190135669	K.20	DEK 5 GW 33	0522660033	4008190073183	K.20
				DEK 5 GW 124	0522660124	4008190054977	K.20	DEK 5 GW 34	0522660034	4008190044992	K.20
				DEK 5 GW 125	0522660125	4008190164140	K.20	DEK 5 GW 35	0522660035	4008190016494	K.20
				DEK 5 GW 126	0522660126	4008190011475	K.20	DEK 5 GW 36	0522660036	4008190106256	K.20
				DEK 5 GW 127	0522660127	400819					

Type	Order No.	EAN-No.	Page	Type	Order No.	EAN-No.	Page	Type	Order No.	EAN-No.	Page
DEK 5 GW 48	0522660048	4008190003777	K.20	DEK 5 GW R	0522761038	4008190038359	K.20	DEK 6 FS 951-999	0468760951	4032248028030	K.20
DEK 5 GW 49	0522660049	4008190189648	K.20	DEK 5 GW R KLEIN	0522861064	4008190161378	K.20	DEK 6 FSZ 1-10	0133360001	4008190125912	K.20
DEK 5 GW 5	0522660005	400819019287	K.20	DEK 5 GW RT/SW +	0576291737	4008190118228	K.20	DEK 6 FSZ 11-20	0133360011	4008190025557	K.20
DEK 5 GW 50	0522660050	4008190150716	K.20	DEK 5 GW S	0522761039	4008190031947	K.20	DEK 6 FSZ 21-30	0133360021	4008190078348	K.20
DEK 5 GW 51	0522660051	4008190072339	K.20	DEK 5 GW S KLEIN	0522861065	4008190157654	K.20	DEK 6 FSZ 31-40	0133360031	4008190023850	K.20
DEK 5 GW 52	0522660052	4008190149116	K.20	DEK 5 GW SL	0537261191		K.20	DEK 6 FSZ 41-50	0133360041	4008190086510	K.20
DEK 5 GW 53	0522660053	4008190033651	K.20	DEK 5 GW T	0522761040	4008190052140	K.20	DEK 6 FSZ 51-60	0133360051	4008190075774	K.20
DEK 5 GW 54	0522660054	4008190037130	K.20	DEK 5 GW T KLEIN	0522861066	4008190153083	K.20	DEK 6 FSZ 61-70	0133360061	4008190182656	K.20
DEK 5 GW 55	0522660055	4008190051229	K.20	DEK 5 GW U	0522761041	4008190162382	K.20	DEK 6 FSZ 71-80	0133360071	4008190062934	K.20
DEK 5 GW 56	0522660056	4008190161262	K.20	DEK 5 GW U KLEIN	0522861067	4008190075880	K.20	DEK 6 FSZ 81-90	0133360081	4008190025120	K.20
DEK 5 GW 57	0522660057	4008190055585	K.20	DEK 5 GW V	0522761042	4008190045647	K.20	DEK 6 FSZ 91-100	0133360091	4008190104719	K.20
DEK 5 GW 58	0522660058	4008190104351	K.20	DEK 5 GW V KLEIN	0522861068	4008190153687	K.20	DEK 6 FW 1,3,5...99	1358686000	4008190139995	K.20
DEK 5 GW 59	0522660059	4008190116538	K.20	DEK 5 GW W	0522761043	4008190118983	K.20	DEK 6 FW 1-5 (10X)	0688686000	4008190148461	K.20
DEK 5 GW 6	0522660006	4008190160890	K.20	DEK 5 GW W KLEIN	0522861069	4008190039417	K.20	DEK 6 FW 1-50	0468686001	4008190170257	K.20
DEK 5 GW 60	0522660060	4008190051129	K.20	DEK 5 GW W-STROM	0576261215	4008190010003	K.20	DEK 6 FW 101-150	0468686011	4008190095970	K.20
DEK 5 GW 61	0522660061	4008190179465	K.20	DEK 5 GW X	0522761044	4008190119966	K.20	DEK 6 FW 151-200	0468686015	4008190125677	K.20
DEK 5 GW 62	0522660062	4008190117665	K.20	DEK 5 GW X KLEIN	0522861070	4008190141615	K.20	DEK 6 FW 2,4,...100	1358760000	4008190095666	K.20
DEK 5 GW 63	0522660063	4008190172602	K.20	DEK 5 GW Y	0522761045	4008190083977	K.20	DEK 6 FW 201-250	0468686021	4008190102883	K.20
DEK 5 GW 64	0522660064	4008190001711	K.20	DEK 5 GW Y KLEIN	0522861071	4008190108496	K.20	DEK 6 FW 251-300	0468686025	4008190020767	K.20
DEK 5 GW 65	0522660065	4008190174750	K.20	DEK 5 GW Z	0522761046	4008190047337	K.20	DEK 6 FW 301-350	0468686031	4008190036331	K.20
DEK 5 GW 66	0522660066	4008190157555	K.20	DEK 5 GW Z KLEIN	0522861072	4008190074265	K.20	DEK 6 FW 351-400	0468686035	4008190033668	K.20
DEK 5 GW 67	0522660067	4008190067207	K.20	DEK 5 NEUTRAL	0473360000	4008190065720	K.9	DEK 6 FW 401-450	0468686041	4008190088965	K.20
DEK 5 GW 68	0522660068	4008190131968	K.20	DEK 5 NEUTRAL	0473360000	4008190065720	K.20	DEK 6 FW 451-500	0468686045	4008190164478	K.20
DEK 5 GW 69	0522660069	4008190004682	K.20	DEK 5 OR NEUTRAL	0473391690	4008190159375	K.20	DEK 6 FW 501-550	0468686051	4008190067700	K.20
DEK 5 GW 7	0522660007	4008190011949	K.20	DEK 5 RT NEUTRAL	0473391686	4008190014025	K.20	DEK 6 FW 51-100	0468686055	4008190121540	K.20
DEK 5 GW 70	0522660070	4008190070199	K.20	DEK 5 SONDERDRUCK	0490760000	4008190450250	K.9	DEK 6 FW 551-600	0468686059	4008190068103	K.20
DEK 5 GW 71	0522660071	4008190024284	K.20	DEK 5 SW NEUTRAL	0473391694	4008190085407	K.20	DEK 6 FW 601-650	0468686061	4008190009830	K.20
DEK 5 GW 72	0522660072	4008190167028	K.20	DEK 5 VI NEUTRAL	0473391689	4008190102494	K.20	DEK 6 FW 651-700	0468686065	4008190053338	K.20
DEK 5 GW 73	0522660073	4008190048426	K.20	DEK 5/3,5 MC bedruckt	1767730000	4032248102532	K.9	DEK 6 FW 701-750	0468686071	4008190033330	K.20
DEK 5 GW 74	0522660074	4008190083948	K.20	DEK 5/3,5 MC bedruckt	1767730000	4032248102532	K.20	DEK 6 FW 751-800	0468686075	4008190156589	K.20
DEK 5 GW 75	0522660075	4008190118600	K.20	DEK 5/3,5 MC FSZ 1-10	1762320001	4032248043552	K.20	DEK 6 FW 801-850	0468686081	4008190174767	K.20
DEK 5 GW 76	0522660076	4008190008064	K.20	DEK 5/3,5 MC FSZ 101-110	1762320101	4032248043651	K.20	DEK 6 FW 851-900	0468686085	4008190185985	K.20
DEK 5 GW 77	0522660077	4008190006693	K.20	DEK 5/3,5 MC FSZ 11-20	1762320111	4032248043569	K.20	DEK 6 FW 901-950	0468686091	4008190053505	K.20
DEK 5 GW 78	0522660078	4008190122607	K.20	DEK 5/3,5 MC FSZ 111-120	1762320111	4032248043668	K.20	DEK 6 FW 951-999	0468686095	4008190179069	K.20
DEK 5 GW 79	0522660079	4008190165345	K.20	DEK 5/3,5 MC FSZ 121-130	1762320121	4032248043675	K.20	DEK 6 FW L,N,PE	0632560000	4008190006684	K.20
DEK 5 GW 8	0522660008	4008190171513	K.20	DEK 5/3,5 MC FSZ 131-140	1762320131	4032248043682	K.20	DEK 6 FWZ 1-10	0518960001	4008190014261	K.20
DEK 5 GW 80	0522660080	4008190016500	K.20	DEK 5/3,5 MC FSZ 141-150	1762320141	4032248043699	K.20	DEK 6 FWZ 101-110	0518960101	4008190133535	K.20
DEK 5 GW 81	0522660081	4008190021658	K.20	DEK 5/3,5 MC FSZ 21-30	1762320201	4032248043676	K.20	DEK 6 FWZ 11-20	0518960111	4008190104948	K.20
DEK 5 GW 82	0522660082	4008190145743	K.20	DEK 5/3,5 MC FSZ 31-40	1762320301	4032248043583	K.20	DEK 6 FWZ 111-120	0518960111	4008190084912	K.20
DEK 5 GW 83	0522660083	4008190042028	K.20	DEK 5/3,5 MC FSZ 41-50	1762320401	4032248043590	K.20	DEK 6 FWZ 121-130	0518960121	4008190187213	K.20
DEK 5 GW 84	0522660084	4008190128968	K.20	DEK 5/3,5 MC FSZ 51-60	1762320501	4032248043606	K.20	DEK 6 FWZ 131-140	0518960131	4008190078621	K.20
DEK 5 GW 85	0522660085	4008190143718	K.20	DEK 5/3,5 MC FSZ 61-70	1762320601	4032248043613	K.20	DEK 6 FWZ 141-150	0518960141	4008190157517	K.20
DEK 5 GW 86	0522660086	4008190121822	K.20	DEK 5/3,5 MC FSZ 71-80	1762320701	4032248043620	K.20	DEK 6 FWZ 151-160	0518960151	4008190162672	K.20
DEK 5 GW 87	0522660087	4008190089857	K.20	DEK 5/3,5 MC FSZ 81-90	1762320801	4032248043637	K.20	DEK 6 FWZ 161-170	0518960161	4008190131423	K.20
DEK 5 GW 88	0522660088	4008190004187	K.20	DEK 5/3,5 MC FSZ 91-100	1762320901	4032248043644	K.20	DEK 6 FWZ 171-180	0518960171	4008190181132	K.20
DEK 5 GW 89	0522660089	4008190063436	K.20	DEK 5/3,5 MC GW 0	1755282000	4032248017454	K.20	DEK 6 FWZ 181-190	0518960181	4008190159467	K.20
DEK 5 GW 9	0522660009	4008190105129	K.20	DEK 5/3,5 MC GW 1	1755282001	4032248017362	K.20	DEK 6 FWZ 191-200	0518960191	4008190064105	K.20
DEK 5 GW 90	0522660090	4008190079860	K.20	DEK 5/3,5 MC GW 2	1755282002	4032248017379	K.20	DEK 6 FWZ 201-210	0518960201	4008190024994	K.20
DEK 5 GW 91	0522660091	4008190101462	K.20	DEK 5/3,5 MC GW 3	1755282003	4032248017386	K.20	DEK 6 FWZ 21-30	0518960021	4008190158132	K.20
DEK 5 GW 92	0522660092	4008190049973	K.20	DEK 5/3,5 MC GW 4	1755282004	4032248017393	K.20	DEK 6 FWZ 31-40	0518960031	4008190103156	K.20
DEK 5 GW 93	0522660093	4008190153533	K.20	DEK 5/3,5 MC GW 5	1755282005	4032248017409	K.20	DEK 6 FWZ 41-50	0518960041	4008190165000	K.20
DEK 5 GW 94	0522660094	4008190065126	K.20	DEK 5/3,5 MC GW 6	1755282006	4032248017416	K.20	DEK 6 FWZ 51-60	0518960051	4008190155476	K.20
DEK 5 GW 95	0522660095	4008190089525	K.20	DEK 5/3,5 MC GW 7	1755282007	4032248017423	K.20	DEK 6 FWZ 61-70	0518960061	4008190071493	K.20
DEK 5 GW 96	0522660096	4008190089696	K.20	DEK 5/3,5 MC GW 8	1755282008	4032248017430	K.20	DEK 6 FWZ 71-80	0518960071	4008190142919	K.20
DEK 5 GW 97	0522660097	4008190082697	K.20	DEK 5/3,5 MC GW 9	1755282009	4032248017447	K.20	DEK 6 FWZ 81-90	0518960081	4008190104412	K.20
DEK 5 GW 98	0522660098	4008190003876	K.20	DEK 5/3,5 MC NEUTRAL	1755272000	4032248017348	K.9	DEK 6 FWZ 91-100	0518960091	4008190183037	K.20
DEK 5 GW 99	0522660099	4008190078713	K.20	DEK 5/3,5 MC NEUTRAL	1755272000	4032248017348	K.20	DEK 6 FWZ L1-ERDE I,KRE	0631961203	4008190037208	K.20
DEK 5 GW A	0522761021	4008190037185	K.20	DEK 5/6 MC BEDRUCKT	1609810000	4008190456597	K.9	DEK 6 FWZ L1-PE	0631961187	4008190154561	K.20
DEK 5 GW A KLEIN	0522861047	4008190017057	K.20	DEK 5/6 MC BEDRUCKT	1609810000	4008190456597	K.20	DEK 6 FWZ R,S,T,N,ERDE	0631886000	4008190167417	K.20
DEK 5 GW B	0522761022	40081900979321	K.20	DEK 5/6 MC-10 NEUT. BL	1609801693	4008190397166	K.20	DEK 6 GE NEUTRAL	0468591687	4008190083083	K.20
DEK 5 GW B KLEIN	0522861048	4008190098454	K.20	DEK 5/6 MC-10 NEUT. GE	1609801687	4008190397135	K.20	DEK 6 GN NEUTRAL	0468591688	4008190163709	K.20
DEK 5 GW BL/SW -	0576291741	4008190081393	K.20	DEK 5/6 MC-10 NEUT. GN	1609801688	4008190397142	K.20	DEK 6 GR NEUTRAL	0468591691	4008190081454	K.20
DEK 5 GW C	0522761023	4008190085278	K.20	DEK 5/6 MC-10 NEUT. GR	1609801691	4008190397159	K.20	DEK 6 GW +	1318061198	4008190159979	K.20
DEK 5 GW C KLEIN	0522861049	4008190107895	K.20	DEK 5/6 MC-10 NEUT. RT	1609801686	4008190397128	K.20	DEK 6 GW -	1318061199	4008190856571	K.20
DEK 5 GW D	0522761024	4008190090234	K.20	DEK 5/6 MC-10 NEUT. VAR	1609800000		K.20	DEK 6 GW 1	0526960001	4008190128234	K.20
DEK 5 GW D KLEIN	0522861050	4008190103804	K.20	DEK 5/6 MC-10 NEUT. WS	1609801044	4008190397111	K.20	DEK 6 GW 10	0526960010	4008190168241	K.20
DEK 5 GW E	0522761025	4008190022891	K.20	DEK 5/6 MC-10 NEUT. WS	1609801044	4008190397111	K.9	DEK 6 GW 100	0526960100	4008190059194	K.20
DEK 5 GW E KLEIN	0522861051	4008190038863	K.20	DEK 5/6 Plus MC Neutral	1854490000	4032248393596	K.9	DEK 6 GW 11	0526960011	4008190063337	K.20
DEK 5 GW ERDE	0522661202	4008190040352	K.20	DEK 5/6 MC BEDRUCKT	1609830000	4008190456603	K.9	DEK 6 GW 12	0526960012	4008190076313	K.20
DEK 5 GW ERDE I,KR.	0576261203	4008190167097	K.20	DEK 5/6 MC BEDRUCKT	1609830000	4008190456603	K.20	DEK 6 GW 13	0526960013	4008190053048	K.20
DEK 5 GW F	0522761026	4008190110079									

Type	Order No.	EAN-No.	Page	Type	Order No.	EAN-No.	Page	Type	Order No.	EAN-No.	Page
DEK 6 GW 40	0526960040	4008190181659	K.20	DEK 6,5 FS 801-850	0468260801	4008190143343	K.22	DEK 8 FW 51-100 TAMPOP.	1653340051	4008190403812	K.20
DEK 6 GW 41	0526960041	4008190088897	K.20	DEK 6,5 FS 851-900	0468260851	4008190154585	K.22	DEK 8 FW 51-100 TAMPOP.	1653340051	4008190403812	K.22
DEK 6 GW 42	0526960042	4008190149444	K.20	DEK 6,5 FS 851-900	0468260851	4008190154585	K.20	DEK 8 FWZ 1-10	1276960001	4008190100575	K.22
DEK 6 GW 43	0526960043	4008190018498	K.20	DEK 6,5 FS 901-950	0468260901	4008190159337	K.22	DEK 8 FWZ 1-10	1276960001	4008190100575	K.20
DEK 6 GW 44	0526960044	4008190006235	K.20	DEK 6,5 FS 901-950	0468260901	4008190159337	K.20	DEK 8 FWZ 101-110	1276960101	4032248028085	K.22
DEK 6 GW 45	0526960045	4008190148287	K.20	DEK 6,5 FS 951-999	0468260951	4008190095239	K.22	DEK 8 FWZ 101-110	1276960101	4032248028085	K.20
DEK 6 GW 46	0526960046	4008190098704	K.20	DEK 6,5 FS 951-999	0468260951	4008190095239	K.20	DEK 8 FWZ 11-20	1276960011	4008190000226	K.22
DEK 6 GW 47	0526960047	4008190166847	K.20	DEK 6,5 FSZ 1-10	0407360001	4008190049980	K.20	DEK 8 FWZ 11-20	1276960011	4008190000226	K.20
DEK 6 GW 48	0526960048	4008190009809	K.20	DEK 6,5 FSZ 1-10	0407360011	4008190141172	K.20	DEK 8 FWZ 111-120	1276960111	4008190135577	K.20
DEK 6 GW 49	0526960049	4008190005863	K.20	DEK 6,5 FSZ 21-30	0407360021	4008190003494	K.20	DEK 8 FWZ 111-120	1276960111	4008190135577	K.22
DEK 6 GW 5	0526960005	4008190125202	K.20	DEK 6,5 FSZ 31-40	0407360031	4008190139346	K.20	DEK 8 FWZ 121-130	1276960121	4008190168339	K.20
DEK 6 GW 50	0526960050	4008190156367	K.20	DEK 6,5 FSZ 41-50	0407360041	4008190011055	K.20	DEK 8 FWZ 121-130	1276960121	4008190168339	K.22
DEK 6 GW 51	0526960051	4008190078027	K.20	DEK 6,5 FSZ 51-60	0407360051	4008190006639	K.20	DEK 8 FWZ 131-140	1276960131	4008190164713	K.22
DEK 6 GW 52	0526960052	4008190189525	K.20	DEK 6,5 FSZ 61-70	0407360061	4008190108571	K.20	DEK 8 FWZ 131-140	1276960131	4008190164713	K.20
DEK 6 GW 53	0526960053	4008190033979	K.20	DEK 6,5 FSZ 71-80	0407360071	4008190177829	K.20	DEK 8 FWZ 141-150	1276960141	4032248028092	K.20
DEK 6 GW 54	0526960054	4008190043193	K.20	DEK 6,5 FSZ 81-90	0407360081	4008190140694	K.20	DEK 8 FWZ 141-150	1276960141	4032248028092	K.22
DEK 6 GW 55	0526960055	4008190045920	K.20	DEK 6,5 FSZ 91-100	0407360091	4008190029258	K.20	DEK 8 FWZ 21-30	1276960021	4008190018139	K.22
DEK 6 GW 56	0526960056	4008190166601	K.20	DEK 6,5 FW 1-50	0468160001	4008190070816	K.20	DEK 8 FWZ 21-30	1276960021	4008190018139	K.20
DEK 6 GW 57	0526960057	4008190061593	K.20	DEK 6,5 FW 101-150	0468160101	4008190085346	K.20	DEK 8 FWZ 31-40	1276960031	4008190153625	K.20
DEK 6 GW 58	0526960058	4008190110420	K.20	DEK 6,5 FW 151-200	0468160151	4008190115029	K.20	DEK 8 FWZ 31-40	1276960031	4008190153625	K.22
DEK 6 GW 59	0526960059	4008190157760	K.20	DEK 6,5 FW 201-250	0468160201	4008190026752	K.20	DEK 8 FWZ 41-50	1276960041	4008190061067	K.22
DEK 6 GW 6	0526960006	4008190012069	K.20	DEK 6,5 FW 251-300	0468160251	4008190170493	K.20	DEK 8 FWZ 41-50	1276960041	4008190061067	K.20
DEK 6 GW 60	0526960060	40081900057145	K.20	DEK 6,5 FW 301-350	0468160301	4008190121761	K.20	DEK 8 FWZ 51-60	1276960051	4008190050535	K.20
DEK 6 GW 61	0526960061	4008190030926	K.20	DEK 6,5 FW 351-400	0468160351	4008190118921	K.20	DEK 8 FWZ 51-60	1276960051	4008190050535	K.22
DEK 6 GW 62	0526960062	4008190123628	K.20	DEK 6,5 FW 401-450	0468160401	4008190108045	K.20	DEK 8 FWZ 61-70	1276960061	4008190158422	K.22
DEK 6 GW 63	0526960063	4008190178314	K.20	DEK 6,5 FW 451-500	0468160451	4008190183219	K.20	DEK 8 FWZ 61-70	1276960061	4008190158422	K.20
DEK 6 GW 64	0526960064	4008190007812	K.20	DEK 6,5 FW 501-550	0468160501	4008190021269	K.20	DEK 8 FWZ 71-80	1276960071	4008190002343	K.20
DEK 6 GW 65	0526960065	4008190026363	K.20	DEK 6,5 FW 51-100	0468160501	4008190021542	K.20	DEK 8 FWZ 71-80	1276960071	4008190002343	K.22
DEK 6 GW 66	0526960066	4008190163006	K.20	DEK 6,5 FW 551-600	0468160551	4008190175849	K.20	DEK 8 FWZ 81-90	1276960081	4008190155001	K.20
DEK 6 GW 67	0526960067	4008190073411	K.20	DEK 6,5 FW 601-650	0468160601	4008190051938	K.20	DEK 8 FWZ 81-90	1276960081	4008190155001	K.22
DEK 6 GW 68	0526960068	4008190172794	K.20	DEK 6,5 FW 651-700	0468160651	4008190096526	K.20	DEK 8 FWZ 91-100	1276960091	4008190079062	K.20
DEK 6 GW 69	0526960069	4008190010669	K.20	DEK 6,5 FW 701-750	0468160701	4008190010775	K.20	DEK 8 FWZ 91-100	1276960091	4008190079062	K.22
DEK 6 GW 7	0526960007	4008190017191	K.20	DEK 6,5 FW 751-800	0468160751	4008190168766	K.20	DEK 8 GE NEUTRAL	1277091687	4008190944537	K.22
DEK 6 GW 70	0526960070	4008190075958	K.20	DEK 6,5 FW 801-850	0468160801	4008190087128	K.20	DEK 8 GE NEUTRAL	1277091687	4008190944537	K.20
DEK 6 GW 71	0526960071	40081900065621	K.20	DEK 6,5 FW 851-900	0468160851	4008190134044	K.20	DEK 8 GN NEUTRAL	1277091688	4008190944544	K.20
DEK 6 GW 72	0526960072	4008190173098	K.20	DEK 6,5 FW 901-950	0468160901	4008190126148	K.20	DEK 8 GN NEUTRAL	1277091688	4008190944544	K.22
DEK 6 GW 73	0526960073	4008190054373	K.20	DEK 6,5 FW 951-999	0468160951	4008190025649	K.20	DEK 8 NEUTRAL	1277060000	4008190088705	K.22
DEK 6 GW 74	0526960074	4008190125882	K.20	DEK 6,5 FW L1-ERDE I.KR	0632161203	4008190087227	K.22	DEK 8 NEUTRAL	1277060000	4008190088705	K.20
DEK 6 GW 75	0526960075	4008190124571	K.20	DEK 6,5 FW L1-ERDE I.KR	0632161203	4008190087227	K.20	DEK 8 OR NEUTRAL	1277091690	4008190944568	K.22
DEK 6 GW 76	0526960076	4008190006817	K.20	DEK 6,5 FW L1-PE	0632161187	4008190118365	K.22	DEK 8 OR NEUTRAL	1277091690	4008190944568	K.20
DEK 6 GW 77	0526960077	4008190047719	K.20	DEK 6,5 FW L1-PE	0632161187	4008190118365	K.20	DEK 8 RT NEUTRAL	1277091686	4032248048045	K.20
DEK 6 GW 78	0526960078	4008190128388	K.20	DEK 6,5 FWZ 1-10	0519060001	4008190152550	K.22	DEK 8 RT NEUTRAL	1277091686	4032248048045	K.22
DEK 6 GW 79	0526960079	4008190171931	K.20	DEK 6,5 FWZ 1-10	0519060001	4008190152550	K.20	DEK 8 SONDERDR.FARBIG	1326690000	4008190004217	K.20
DEK 6 GW 8	0526960008	4008190177096	K.20	DEK 6,5 FWZ 11-20	0519060011	4008190051747	K.22	DEK 8 SONDERDR.FARBIG	1326690000	4008190004217	K.22
DEK 6 GW 80	0526960080	4008190057671	K.20	DEK 6,5 FWZ 11-20	0519060011	4008190051747	K.20	DEK 8 SONDERDR.WEIB	1326660000	4008190085773	K.20
DEK 6 GW 81	0526960081	4008190027544	K.20	DEK 6,5 FWZ 21-30	0519060021	4008190069797	K.22	DEK 8 SONDERDR.WEIB	1326660000	4008190085773	K.22
DEK 6 GW 82	0526960082	4008190151584	K.20	DEK 6,5 FWZ 21-30	0519060021	4008190069797	K.20	DEK 8 SONDERDR.WEIB	1326660000	4008190085773	K.9
DEK 6 GW 83	0526960083	4008190083670	K.20	DEK 6,5 FWZ 31-40	0519060031	4008190014957	K.22	DEK 8 VI NEUTRAL	1277091689	4008190944551	K.22
DEK 6 GW 84	0526960084	4008190134877	K.20	DEK 6,5 FWZ 31-40	0519060031	4008190014957	K.20	DEK 8 VI NEUTRAL	1277091689	4008190944551	K.20
DEK 6 GW 85	0526960085	4008190149437	K.20	DEK 6,5 FWZ 41-50	0519060041	4008190113278	K.20	DK 4	0355460000	4008190094560	B.10
DEK 6 GW 86	0526960086	4008190162689	K.20	DEK 6,5 FWZ 41-50	0519060041	4008190113278	K.20	DK 4 BL	0355460000	4008190094560	B.10
DEK 6 GW 87	0526960087	4008190104955	K.20	DEK 6,5 FWZ 51-60	0519060051	4008190103026	K.22	DK 4 ST SE 1.6	0370360000	4008190114879	B.40
DEK 6 GW 88	0526960088	4008190010195	K.20	DEK 6,5 FWZ 51-60	0519060051	4008190103026	K.22	DK 4 ST SE 2.4	0527760000	4008190157777	B.40
DEK 6 GW 89	0526960089	4008190105501	K.20	DEK 6,5 FWZ 61-70	0519060061	4008190019730	K.20	DK 4 ST WA 1.6	0370460000	4008190125707	B.40
DEK 6 GW 9	0526960009	4008190110833	K.20	DEK 6,5 FWZ 61-70	0519060061	4008190019730	K.22	DK 4 SW 1X1	0536560000	4008190111069	B.39
DEK 6 GW 90	0526960090	4008190121884	K.20	DEK 6,5 FWZ 71-80	0519060071	4008190054236	K.22	DK 4/32 1D 1K5	0685260000	4008190175986	B.67
DEK 6 GW 91	0526960091	4008190107277	K.20	DEK 6,5 FWZ 71-80	0519060071	4008190054236	K.20	DK 4/32 1D CSA A1	0484060000	4008190068991	B.65
DEK 6 GW 92	0526960092	4008190055950	K.20	DEK 6,5 FWZ 81-90	0519060081	4008190016371	K.22	DK 4/32 1D CSA A1	0484060000	4008190058975	B.65
DEK 6 GW 93	0526960093	4008190004262	K.20	DEK 6,5 FWZ 81-90	0519060081	4008190016371	K.20	DK 4/32 1D CSA A2	0467960000	4008190110321	B.66
DEK 6 GW 94	0526960094	4008190007953	K.20	DEK 6,5 FWZ 91-100	0519060091	4008190131425	K.22	DK 4/32 1D CSA A2	0467960000	4008190110321	B.66
DEK 6 GW 95	0526960095	4008190107332	K.20	DEK 6,5 FWZ 91-100	0519060091	4008190131425	K.20	DK 4/32 1D CSA GET.SCH.	0544660000	4008190182724	B.65
DEK 6 GW 96	0526960096	4008190131081	K.20	DEK 6,5 FWZ R,S,T,N,ERD	0632060000	4008190060329	K.22	DK 4/32 1D CSA GET.SCH.	0544660000	4008190182724	B.65
DEK 6 GW 97	0526960097	4008190008871	K.20	DEK 6,5 FWZ R,S,T,N,ERD	0632060000	4008190060329	K.22	DK 4/32 2D 1K5	0159160000	4008190146405	B.68
DEK 6 GW 98	0526960098	4008190009847	K.20	DEK 6,5 GE NEUTRAL	0468091687	4008190087890	K.20	DK 4/32 2D A1	0663960000	4008190147853	B.67
DEK 6 GW 99	0526960099	4008190120900	K.20	DEK 6,5 GN NEUT							

Type	Order No.	EAN-No.	Page	Type	Order No.	EAN-No.	Page	Type	Order No.	EAN-No.	Page	
DK 4/35 LD GR 24VDC	0395760000	4008190029470	A.50	EP 1/BW SAKG28/32 HP/DB	0271800000	4008190046934	I.5	H				
DK 4/35 LD ROT 24VDC	0209860000	4008190122249	A.51	EP 1/BW SAKG32/35 HP/DB	1381600000	4008190121464	I.5		H 0,75/14 WEIB BD	9004290000	4008190006778	J.9
DK 4/35 LD ROT 24VDC	0210260000	4008190156312	A.51	EP 2 SAKG46/32 HP/DBR	0205300000	4008190171360	I.4		H 1/15 S ZH WEIB	9018690000	4032248017720	J.11
DK 4/35 LD ROT 60VDC	0395560000	4008190168872	A.50	EP 2 SAKG46/35 HP/TF/GE	0205400000	4008190027223	I.4		H0,14/10 T BRAUN SV	9028250000	4008190902018	J.10
DK 4/35 LD ROT 60VDC	0395860000	4008190100636	A.50	EP 2 SAKG46/35 HP/DBR	0180700000	4008190099671	I.4		H0,14/12 GRAU SV	9028240000	4008190902001	J.9
DK 4/35 RC 220R/220N	0053160000	4008190860943	A.57	EP 2 SAKG46/35 HP/TF/GE	0180800000	4008190006938	I.4		H0,25/10 HELLBLAU	9025740000	4008190092054	J.9
DK 4Q ST WA 2.4	1398760000	4008190059576	B.40	EP 2/BW SAKG46/32 HP/DB	0271900000	4008190172497	I.5		H0,25/10 HELLBLAU SV	9026050000	4008190138288	J.9
DK 4Q/32	0590060000	4008190147228	B.10	EP 2/BW SAKG46/35 HP/DBR	0182000000	4008190100957	I.5		H0,25/10T GELB	9021010000	4008190109103	J.10
DK 4Q/32 BL	0590080000	4008190100407	B.10	ESCH 1 M	0280300000	4008190143053	H.2		H0,25/10T GELB SV	9025760000	4008190010027	J.9
DK 4Q/35	0590160000	4008190103521	A.12	EW 15	0382860000	4008190187804	H.10		H0,25/12 HELLBLAU SV	9025780000	4008190053239	J.9
DK 4Q/35 BL	0590180000	4008190088361	A.12	EW 15	0382860000	4008190187804	E.3		H0,25/12 GELB	9021020000	4008190184230	J.10
DK 4Q/35/TC TYP J	1284060000	4008190017347	A.34	EW 15	0382860000	4008190187804	E.2		H0,25/12 HELLBLAU SV	9025760000	4008190053239	J.9
DK 4Q/35/TC TYP K	1284160000	4008190033569	A.34	EW 15/2	1071900000	4008190462949	H.10		H0,25/12T GELB	9021020000	4008190184230	J.10
DK 4Q/35/TC TYP T	1285660000	4008190086060	A.34	EW 35	0383560000	4008190181314	H.10		H0,25/12T GELB SV	9021220000	4008190153786	J.10
DK 4Q/TC TYP J	1338060000	4008190167141	B.34	EW 35	0383560000	4008190181314	B.27		H0,34/10 TÜRKIS SV	9025750000	4008190105365	J.9
DK 4Q/TC TYP K	1338260000	4008190109561	B.34	EW 35 GR 7032	0383530000	4008190027322	H.10		H0,34/10 TÜRKIS SV	9026030000	4008190177171	J.9
DK 4Q/TC TYP T	1338116000	4008190097769	B.34	EW 35/SCHA/M3	0258660000	4008190033477	I.12		H0,34/12 TÜRKIS	9025770000	4008190067960	J.9
DK 4QV/32	0590260000	4008190022419	B.11	EWK 1	0206160000	4008190080020	B.27		H0,34/12 TÜRKIS BD GSP	9004390000	4008190881016	J.9
DK 4QV/32 BL	0590280000	4008190038762	B.11	EWK 1	0206160000	4008190080020	H.10		H0,34/12 TÜRKIS SV	9025790000	4008190121174	J.9
DK 4QV/35	0363660000	4008190165192	A.13	EWK 1 ALT	0495160000	4008190160777	H.10		H0,5/10 ORANGE SV	9028260000	4008190902025	J.9
DK 4QV/35 BL	0363680000	4008190011567	A.13	EWK 2	0199360000	4008190023546	H.10		H0,5/12 ORANGE	0409500000	4008190090456	J.9
DK 4S SF 4X2.8	0631160000	4008190066840	B.38	EWK 2/SCHA/M3/L	0258760000	4008190012182	I.12		H0,5/12D WEISS	9019000000	4008190085728	J.10
DK 4S SF 6.3/2.8	0631260000	4008190007355	B.38	EWK AKA 2.5	0348660000	4008190134419	H.10		H0,5/14 ORANGE	0690700000	4008190015770	J.9
DK 4S/35 SF 4X2.8	0686560000	4008190137458	A.40						H0,5/14 ORANGE BD GSP	9004270000	4008190091777	J.9
DK 4S/35 SF 6.3/2.8	0686660000	4008190100254	A.39						H0,5/14 ORANGE BD	9005810000	4008190275877	J.9
DK 4SS/35 FF 4X6.3/2.8	0217160000	4008190158248	A.39						H0,5/14 ORANGE SV	9026060000	4008190122201	J.9
DK 4SS/35 FF 8X2.8	0297060000	4008190117092	A.39						H0,5/14D WEISS	9019010000	4008190120931	J.10
DKSUE NSCH/ESCH	0280100000	4008190036348	H.2						H0,5/14D WEISS BD	9004280000	4008190162627	J.10
DKT 4	0687360000	4008190059743	B.17	FK 4	1678650000	4008190466763	I.14		H0,5/14D WEISS BD	9004280000	4008190162627	J.10
DKT 4/32 PT100	8014730000	4008190123338	B.70	FKSC M5X8 D9/SW2.5	0295900000	4008190133337	H.11		H0,5/14 WEISS SV	9005860000	4008190275921	J.10
DKT 4/35	0687460000	4008190148690	A.19	FKSC M6X8 D9/SW3	0642600000	4008190058258	H.11		H0,5/14 WEISS SV	9019400000	4008190066024	J.10
DKT 4/35 PT100	8014720000	4008190131289	A.57	FM 4.2/TS35	1724580000	4008190377717	H.11		H0,5/14S TRI ORANGE	9004560000	4008190286132	J.12
DKT 4V 2STB	1304860000	4008190030398	B.17	FM 4/TS35	0687900000	4008190086459	G.10		H0,5/14S TRI WEIB	9004590000	4008190862060	J.12
DKT 4V/35 2STB	1304960000	4008190185503	A.19	FM 5/TS35	0636800000	4008190152949	H.11		H0,5/15 ZH ORANGE	9037200000	4008190492397	J.11
DMS 3	9007440000	4008190404987	J.13	FM 6/TS35	0636900000	4008190174019	H.11		H0,5/15 ZH ORANGE	9037200000	4008190492397	J.12
DMS 3 SET 1	9007470000	4008190299224	J.13	FZS 2/4 RT/80 SAKT4	1276300000	4008190026080	I.14		H0,5/15 ZH WEIB	9004440000	4008190198473	J.11
DMS 3 SET 2	9007480000	4008190405298	J.13						H0,5/15D ZH WEIB	9037380000	4008190492861	J.12
DMS manuell 0,5-1,7	9918370000	4032248388332	J.22						H0,5/15D WEIB ZH SV	9004780000	4008190188481	J.12
DMS manuell 2,0-8,0	9918380000	4032248388349	J.22						H0,5/16 ORANGE SV	9028270000	4008190902049	J.9
DMSI manuell 0,5-1,7	9918390000	4032248388356	J.23						H0,5/16 ORANGE	9025870000	4008190025045	J.9
DMSI manuell 2,0-8,0	9918400000	4032248388363	J.23	G 20/0.10A/F	0430300000	4008190077174	B.26		H0,5/16,5 ZH ORANGE	9037210000	4008190492687	J.12
DQS 2 1D PS2.3 AG	0471460000	4008190035891	I.13	G 20/0.10A/F	0430300000	4008190077174	A.28		H0,5/16,5 ZH ORANGE	9037210000	4008190492687	J.11
DQS 2 PS2.3 AG M.BRUECK	0471560000	4008190002909	I.13	G 20/0.20A/F	0430400000	4008190152383	B.26		H0,5/16,5D ZH WEIB	9037390000	4008190492788	J.12
DQS 2 PS2.3 O.BATE	0471660000	4008190051327	I.13	G 20/0.20A/F	0430400000	4008190152383	A.28		H0,5/16D WEISS	9019020000	4008190047108	J.10
DS 12.5 SAK10	0207630000	4008190087401	I.12	G 20/0.25A/F	0430500000	4008190153991	B.26		H0,5/16D WEISS	9019020000	4008190047108	J.10
DS 12.5 SAK6N	0207730000	4008190148843	I.12	G 20/0.25A/F	0430500000	4008190153991	A.28		H0,5/18,4D ZH WEIB	9037400000	4008190492892	J.12
DS 14 SAK4	0207530000	4008190107925	I.12	G 20/0.50A/F	0430600000	4008190046835	B.26		H0,5/18,5 ZH ORANGE	9037220000	4008190492694	J.12
DS 9 SAK2.5	0330930000	4008190149758	I.12	G 20/0.50A/F	0430600000	4008190046835	A.28		H0,5/18,5 ZH ORANGE	9037220000	4008190492694	J.11
DSTV VH 6.5	0286400000	4008190085339	I.10	G 20/0.63A/F	0439000000	4008190131210	B.26		H0,75/12 WEISS SV	9028280000	4008190902216	J.9
				G 20/0.63A/F	0439000000	4008190131210	B.26		H0,75/12 WEISS	0409600000	4008190079826	J.9
				G 20/1.00A/F	0430700000	4008190093877	B.26		H0,75/12D GRAU	9019030000	4008190127787	J.10
				G 20/1.00A/F	0430700000	4008190093877	A.28		H0,75/12T HELLBLAU	9021030000	4008190152901	J.10
				G 20/1.60A/F	0430800000	4008190031503	A.28		H0,75/14 GRAU BD GSP	9005870000	4008190275938	J.10
				G 20/1.60A/F	0430800000	4008190031503	B.26		H0,75/14 TS HELLBLAU	9018550000	4008190207991	J.12
				G 20/2.00A/F	0430900000	4008190123567	B.26		H0,75/14 WEISS	0462900000	4008190033248	J.9
				G 20/2.00A/F	0430900000	4008190123567	A.28		H0,75/14 WEIB BD GSP	9005820000	4008190275884	J.9
				G 20/2.50A/F	0431000000	4008190085513	B.26		H0,75/14 WEISS SV	9026070000	4008190187163	J.9
				G 20/2.50A/F	0431000000	4008190085513	A.28		H0,75/14D GRAU	9019040000	4008190090977	J.10
				G 20/3.15A/F	0431100000	4008190012977	B.26		H0,75/14D GRAU BD	9004300000	4008190154837	J.10
				G 20/4.00A/F	0431200000	4008190022983	A.28		H0,75/14D GRAU SV	9019410000	4008190164096	J.10
				G 20/4.00A/F	0431200000	4008190022983	A.28		H0,75/14S WEISS	9025960000	4008190009878	J.12
				G 20/5.00A/F	0431300000	4008190185381	A.28		H0,75/14S WEISS SV	9025700000	4008190144104	J.12
				G 20/5.00A/F	0431300000	4008190185381	B.26		H0,75/14T BLAU BD GSP	9005900000	4008190275969	J.10
				G 20/6.30A/F	0431400000	4008190086053	A.28		H0,75/14T HELLBLAU BD	9004310000	4008190179298	J.10
				G 20/6.30A/F	0431400000	4008190086053	B.26		H0,75/14T HELLBLAU SV	9021230000	4008190153106	J.10
				G 25/0.25A/M GE	0546900000	4008190097370	B.26		H0,75/15 ZH WEIB	9037230000	4008190853976	J.11
				G 25/0.25A/M GE	0546900000	4008190097370	A.28		H0,75/15 ZH WEIB SV	9018510000	4008190019914	J.11
				G 25/0.50A/M WS	0510300000	400819018368	B.26		H0,75/15D ZH GRAU	9037410000	4008190492984	J.12
				G 25/0.50A/M WS	0510300000	400819018368	A.28		H0,75/15D ZH GRAU SV	9018520000	4008190097998	J.12
				G 25/0.80A/M GR	0646400000	4008190060794	A.28		H0,75/15T ZH HELLBLAU	9037610000	4008190493233	J.12
				G 25/1.00A/M RT	0646400000	4008190060794	B.26		H0,75/15T ZH BLAU SV	9018570000	4008190272630	J.12
				G 25/1.00A/M RT	0265800000	4008190141660	B.26		H0,75/16 WEISS SV	9028290000	4008190902056	J.9
				G 25/10.0A/M RT	0265800000							

Type	Order No.	EAN-No.	Page	Type	Order No.	EAN-No.	Page	Type	Order No.	EAN-No.	Page
H1,0/15D ZH ROT SV	9018540000	4008190188832	J.12	H2,5/14 BLAU SV	9026100000	4008190141141	J.9	HP 8 ADP 1	0258360000	4008190114510	I.16
H1,0/16 GELB SV	9028320000	4008190902087	J.9	H2,5/14 BLAU SV	9026100000	4008190141141	J.10	HP EK132/2 AD250	0634300000	4008190022426	I.18
H1,0/18 GELB SV	9028340000	4008190902100	J.9	H2,5/14D BLAU	9019160000	4008190028732	J.9	HTG 58	9012000000	4008190118372	I.14
H1,0/20 ZH GELB SV	9004910000	4008190482688	J.11	H2,5/14D BLAU	9019160000	4008190028732	J.9	HTI 15	9014400000	4008190159412	J.8
H1,0/20 ZH GELB	9037270000	4008190492748	J.11	H2,5/14D BLAU BD	9004360000	4008190083397	J.9				
H1,0/20D ZH ROT	9037450000	4008190493028	J.12	H2,5/14D BLAU BD	9004360000	4008190083397	J.10				
H1,0/20D ROT ZH SV	9004760000	4008190160951	J.12	H2,5/14D BLAU BD GSP	9005850000	4008190275914	J.10				
H1,0/25,6 ZH GELB	9037280000	4008190492755	J.11	H2,5/14D BLAU BD GSP	9005850000	4008190275914	J.9				
H1,0/25,6D ZH ROT	9037460000	4008190493035	J.12	H2,5/14S BLAU	1333100000	4008190160364	J.12	IK 16/6 BL ZB16/6	0565580000	4008190161774	H.4
H1,5/12S ROT	9025690000	4008190059439	J.12	H2,5/14T GRAU	9021070000	4008190128944	J.10	IK 16/6 GG ZB16	0565580000	4008190112448	H.4
H1,5/14 ROT	0046310000	4008190065089	J.9	H2,5/14T GRAU BD	9004370000	4008190052508	J.10	IK 16/6 ZB16 BL	0502980000	4008190159696	H.4
H1,5/14 ROT BD	9004340000	4008190080723	J.9	H2,5/14T GRAU BD GSP	9005810000	4008190275976	J.10	IK 16/6 ZB16 GG	0502960000	4008190113438	H.4
H1,5/14 ROT BD GSP	9005840000	4008190275907	J.9	H2,5/14T GRAU SV	9021240000	4008190115302	J.10	IK 35/ZB35 GG	0502780000	4008190141455	H.4
H1,5/14 ROT SV	9026090000	4008190137168	J.9	H2,5/14TS grau	9426770000	4032248160693	J.12	IK 4 BL ZB4	0502760000	4008190157678	H.4
H1,5/14D SCHWARZ	9019120000	4008190153793	J.10	H2,5/16 DS BLAU	9036220000	4032248068012	J.12	IK 4 GG ZB4	0475460000	4008190065348	H.4
H1,5/14D SCHWARZ BD	9004350000	4008190005474	J.10	H2,5/16 TS GRAU	9036220000	4032248068005	J.12	IK 4/6 BL ZB4/6	0565380000	4008190093440	H.4
H1,5/14D SCHWARZ BD	9004350000	4008190005474	J.10	H2,5/17,5X BLAU SV	9006670000	4008190332273	J.11	IK 6 BL ZBEEK	0526080000	4008190032245	H.4
H1,5/14D SCHWARZ BD GSP	9005890000	4008190275952	J.10	H2,5/18,5D ZH BLAU	9037500000	4008190493073	J.11	IK 6 GG ZBEEK	0526060000	4008190128647	H.4
H1,5/14D SCHWARZ SV	9019430000	4008190107420	J.10	H2,5/18,5D ZH BLAU	9037500000	4008190493073	J.12	IS 3 KG	1806650000	4032248276820	J.24
H1,5/14DS schwarz SV	9028360000	4032248023219	J.12	H2,5/18,5D ZH BLAU SV	9004430000	4008190099367	J.11	IS 4 KG	1806660000	4032248276837	J.24
H1,5/14S ROT	9025980000	4008190080730	J.12	H2,5/18,5D ZH BLAU SV	9004430000	4008190099367	J.12	IS2 KG	1806630000	4032248276813	J.24
H1,5/14S ROT SV	9025720000	4008190072589	J.12	H2,5/18,5T ZH GRAU	9037640000	4008190493325	J.12	ISPF QB58 BL	0546080000	4008190927035	I.13
H1,5/14S SCHWARZ	9025240000	4008190085651	J.12	H2,5/18,5 T ZH GRAU SV	9018580000	4008190272647	J.12	ISPF QB58 RT	0546040000	4008190497941	I.13
H1,5/16 ROT SV	9028350000	4008190902117	J.9	H2,5/18D BLAU	9019170000	4008190178024	J.10	ISPF QB58 SW	0546000000	4008190116705	I.13
H1,5/16 ROT	0635100000	4008190141745	J.9	H2,5/18D BLAU	9019170000	4008190178024	J.9	ISPF QB75 BL	0526780000	4008190093105	I.13
H1,5/16 ZH ROT	9037290000	4008190492762	J.11	H2,5/18T GRAU	9021080000	4008190149345	J.10	ISPF QB75 RT	0526760000	4008190157821	I.13
H1,5/16 ZH ROT SV	9004410000	4008190009397	J.11	H2,5/20,5 T ZH GRAU SV	9005150000	4008190482732	J.12	ISPF QB75 SW	0526700000	4008190093723	I.13
H1,5/16D ZH SCHWARZ	9037470000	4008190493042	J.12	H2,5/20,5D ZH BLAU	9037510000	4008190493080	J.12				
H1,5/16D SCHWARZ	9019130000	4008190023331	J.10	H2,5/20,5D ZH BLAU	9037510000	4008190493080	J.11				
H1,5/16D SCHWARZ	9019130000	4008190023331	J.10	H2,5/20,5D BLAU ZH SV	9004740000	4008190031923	J.12				
H1,5/16D ZH SCHWARZ SV	9004420000	4008190167455	J.12	H2,5/20,5D BLAU ZH SV	9004740000	4008190031923	J.11				
H1,5/17,5X SCHWARZ SV	9006590000	4008190332259	J.11	H2,5/20,5T ZH GRAU	9037650000	4008190493356	J.12	KDKS 1/32	9503300000	4008190085688	B.21
H1,5/18D SCHWARZ	9019140000	4008190046206	J.10	H2,5/21,5X BLAU SV	9006710000	4008190332280	J.10	KDKS 1/35	9503310000	4008190182304	A.23
H1,5/18D SCHWARZ	9019140000	4008190046206	J.10	H2,5/24D BLAU	9019180000	4008190101145	J.10	KDKS1/EN LD 115VAC	8142840000	4008190047689	C.5
H1,5/19,5X SCHWARZ SV	9006630000	4008190332266	J.11	H2,5/24D BLAU	9019180000	4008190101145	J.9	KDKS1/EN LD 230VAC	8148910000	4008190096076	C.5
H1,5/20 ZH ROT SV	9004920000	4008190482695	J.11	H2,5/24T GRAU	9021090000	4008190060916	J.10	KDKS1/EN LD 24 VAC	8148930000	4008190002572	C.5
H1,5/20 ZH ROT	9037300000	4008190492779	J.11	H2,5/26,5D ZH BLAU	9037520000	4008190493097	J.11	KDKS1/EN LD 24VDC	8146450000	4008190171902	C.5
H1,5/20D ZH SCHWARZ	9037480000	4008190493059	J.12	H2,5/26,5D ZH BLAU	9037520000	4008190493097	J.12	KDKS1/EN LD 48 VAC	8148920000	4008190085803	C.5
H1,5/20D SCHWARZ ZH SV	9004750000	4008190055543	J.12	H2,5/26,5T ZH GRAU	9037660000	4008190493387	J.12	KISC M2.5X11/4.5 AKZ1.5	0400100000	4008190068196	I.9
H1,5/24 ROT	0565600000	4008190187071	J.9	H25/30 BRAUN	0317000000	4008190158231	J.9	KISC M3X15/6 SAK2.5	0359000000	4008190061548	L.10
H1,5/24D SCHWARZ	9019150000	4008190151676	J.10	H25/30D 16 GELB	9019280000	4008190038380	J.10	KISC M3X15/6 SAK2.5	0359000000	4008190061548	L.9
H1,5/24D SCHWARZ SV	9004140000	4008190144982	J.10	H25/30T SCHWARZ	9021190000	4008190115166	J.10	KISC M3X15/6 SAK2.5 CU5	0377200000	4008190006889	I.12
H1,5/24D SCHWARZ SV	9004140000	4008190144982	J.10	H25/36 BRAUN	0317100000	4008190049751	J.9	KISC M3X20 SAK10 CU5	0377100000	4008190060350	I.12
H1,5/25,6 ZH ROT	9037310000	4008190492786	J.11	H25/36D GELB	9019300000	4008190054984	J.10	KISC M3X20 SAK10 CU5	0377100000	4008190060350	I.21
H1,5/25,6D ZH SCHWARZ	9037490000	4008190493066	J.12	H25/36T SCHWARZ	9021200000	4008190055400	J.10	KISC M3X20,5/10 EK4	0303000000	4008190163686	L.9
H1/12 GELB	0409700000	4008190152222	J.9	H35/30 BEIGE	0317200000	4008190023900	J.9	KISC M3X20,5/10 EK4	0303000000	4008190163686	L.10
H1/12 ROT	9019070000	4008190029074	J.10	H35/30D 16 ROT	9019310000	4008190102234	J.10	KISC M3X6 SAKS1	0346200000	4008190175658	B.27
H1/12D ROT	9019070000	4008190029074	J.10	H35/30D ROT	9019320000	4008190111847	J.10	KISC M5X50/26 SAK9.5	0630200000	4008190024246	L.9
H1/14 GELB	0463000000	4008190024697	J.9	H35/39D BEIGE	0317300000	4008190151294	J.9	KLBU 10-20 CFF	1752701001	403224804436	G.11
H1/14 GELB BD	9004320000	4008190167523	J.9	H35/39D ROT	9019330000	4008190048365	J.10	KLBU 10-20 SC	1712321001	4032248032341	G.8
H1/14 GELB SV	9026080000	4008190026158	J.9	H4,0/14 DS GRAU	9028520000	4032248049035	J.12	KLBU 15-32 CFF	1752711001	4032248044443	G.11
H1/14D ROT	9019080000	4008190090623	J.10	H4,0/15 TS ORANGE	9036230000	4032248068029	J.12	KLBU 3-8 CPF SS	1752681001	4032248064439	G.11
H1/14D ROT BD	9004330000	4008190047498	J.10	H4,0/19,5X GRAU SV	9006750000	4008190332297	J.11	KLBU 3-8 SC	1692261001	4032248042365	G.8
H1/14D ROT BD	9004330000	4008190047498	J.10	H4,0/22D ZH GRAU	9037530000	4008190493103	J.11	KLBU 4-13.5 CFF	1752691001	4032248044429	G.11
H1/14D ROT SV	9019420000	4008190189099	J.10	H4,0/22D ZH GRAU	9037530000	4008190493103	J.12	KLBU 4-13.5 SC	1712311001	4032248032358	G.8
H1/14S GELB	9025970000	4008190063733	J.12	H4,0/22T ZH ORANGE	9037670000	4008190493431	J.12	KLBU 10-20	1600490000	4008190151879	G.4
H1/14S ROT	9018560000	4008190207984	J.12	H4,0/22T ZH ORANGE SV	9018590000	4008190272654	J.12	KLBU 15-32	1716300000	4008190350594	G.4
H1/16 GELB	9025950000	4008190037291	J.9	H4,0/28D ZH GRAU	9037540000	4008190493110	J.12	KLBU 15-32 SC	1718341001	4032248032303	G.8
H1/16D ROT	9019100000	4008190159986	J.10	H4,0/28D ZH GRAU	9037540000	4008190493110	J.11	KLBU 2X2-6	1675350000	4008190450080	B.9
H1/16D ROT	9019100000	4008190159986	J.10	H4,0/28T ZH ORANGE	9037680000	4008190493479	J.12	KLBU 3-8	1600480000	4008190130589	G.4
H1/18 GELB	9025930000	4008190101497	J.9	H4/17 GRAU SV	9026010000	4008190117382	J.9	KLBU 4-13.5	1592810000	4008190182250	G.4
H1/18D ROT	9019110000	4008190174828	J.10	H4/17D GRAU SV	9026010000	4008190117382	J.10	KLBU CO 1	1753311001	4032248064427	G.5
H1/18D ROT	9006810000	4008190174828	J.10	H4/17D GRAU	9019190000	4008190141349	J.10	KLBU CO 2	1752131001	4032248064434	G.5
H10,0/24,5X ROT SV	9006830000	4008190332310	J.11	H4/17D GRAU	9019190000	4008190141349	J.9	KLBU CO 3	1749151001	4032248064441	G.5
H10,0/26 ZH ELFENBEIN	9037340000	4008190492918	J.11	H4/17T GRAU	9021100000	4008190061708	J.10	KLBU CO 4	1749161001	4032248064447	G.5
H10,0/26 ZH ELFENBEIN SV	9004940000	4008190482718	J.11	H4/17T ORANGE SV	9021250000	4008190159313	J.10	KLBU CO 5	1755081001	4032248064452	G.5
H10,0/26D ZH ROT	9037570000	4008190493141	J.12	H4/20D GRAU	9019200000	4008190126575	J.9	KLBU SH1	0635960000	4008190007140	H.3
H10,0/26T ZH BRAUN	9037710000	4008190493516	J.12	H4/20D GRAU	9019200000	4008190126575	J.10	KMVF LI 6.3 EP/SW	0249100000	4008190085476	D.8
H10,0/26T ZH BRAUN SV	9005170000	4008190482756	J.12	H4/20T ORANGE	9021110000	4008190357554	J.10	KMVF RE 6.3 EP/SW	0492000000	4008190004019	D.8
H10,0/30 ZH ELFENBEIN	9037350000	4008190492823	J.11	H4/22D GRAU ZH/SV	9004730000	4008190161811	J.12	KMVT LI 2.4 EP/SW	0249300000	4008190004798	D.9
H10,0/30D ZH ROT	9037580000	4008190493158	J.12	H4/22D GRAU ZH ROT	9004730000	4008190161811	J.11	KMVT RE 2.4 EP/SW	0249400000	4008190159016	D.9
H10,0/30T ZH BRAUN	9037720000	4008190493530	J.12	H4/26D GRAU	9019210000	4008190002336	J.10	KS 10 O.D.10	0141620000	4008190053697	F.4
H10/22 ELFENBEIN	0534200000	4008190033460	J.9	H4/26D GRAU	9019210000	4008190002336	J.9	KS 2 O.D.2	0134420000	4008190084813	F.4
H10/22D ROT	9019240000	4008190075385	J.10	H4/26T ORANGE	9021120000	4008190092825	J.10	KS 4 O.D.4</			

Type	Order No.	EAN-No.	Page	Type	Order No.	EAN-No.	Page	Type	Order No.	EAN-No.	Page
M				P							
Magazin PrintJet	1813090000	0032248296521	K.19	P 14/10 D01 RT SAKS4	0328700000	4008190010294	B.27	QB 2 WI RA6 IS	0482700000	4008190166021	E.3
Magazin S-Mark Laser	1782880000	0032248179527	K.18	P 14/10 D01 RT SAKS4	0328700000	4008190010294	A.29	QB 2 WI RA6 IS	0482700000	4008190166021	I.13
MB M3/M3 CRM	0503500000	4008190182083	H.11	P 14/2 D01 RS SAKS4	0138000000	4008190114664	B.29	QB 2 WI RA8 IS	0461100000	4008190034818	I.13
MB M5/M3 SW	0553400000	4008190122263	H.11	P 14/2 D01 RS SAKS4	0138000000	4008190114664	A.29	QB 25/6.11.5 SAKR	0134000000	4008190118945	E.3
MB M6/M4 GR	0334900000	4008190057602	H.11	P 14/4 D01 BR SAKS4	0138100000	4008190077365	B.29	QB 3 SAKT1	0205800000	4008190173364	I.21
MF 10/5 MC FS 1-50	1681200001	4008190910150	K.13	P 14/4 D01 BR SAKS4	0138100000	4008190077365	A.29	QB 3 WI RA6 IS	0482800000	4008190145217	I.13
MF 10/5 MC FS 101-150	1681200101	4008190910174	K.13	P 14/6 D01 GN SAKS4	0328600000	4008190004248	A.29	QB 3 WI RA8 IS	0461200000	4008190161699	I.13
MF 10/5 MC FS 151-200	1681200151	4008190910181	K.13	P 14/6 D01 GN SAKS4	0328600000	4008190004248	B.27	QB 4 SAKT1	0205900000	4008190046200	I.21
MF 10/5 MC FS 51-100	1681200051	4008190910167	K.13	P 16/10 RT SAKS2	0208900000	4008190112578	B.27	QB 4 WI RA6 IS	0482900000	4008190086169	I.13
MF 10/5 MC FSZ 1-10	1681210001	4008190929558	K.13	P 16/10 RT SAKS2	0208900000	4008190112578	A.29	QB 4 WI RA6 IS	0482900000	4008190086169	E.3
MF 10/5 MC FSZ L1,L2-PE	1681571187	4008190929794	K.13	P 16/16 GR SAKS2	0209000000	4008190144937	B.27	QB 58/8/15	0545400000	4008190028794	I.13
MF 10/5 MC FW 1-50	1681080001	4008190899141	K.13	P 16/16 GR SAKS2	0209000000	4008190144937	A.29	QB 58/9/WI	0545300000	4008190125080	I.13
MF 10/5 MC FW 101-150	1681080101	4008190899165	K.13	P 16/20 BL SAKS2	0209100000	4008190055493	B.27	QB 75/6.2/15	0535200000	4008190179168	I.13
MF 10/5 MC FW 151-200	1681080151	4008190899189	K.13	P 16/20 BL SAKS2	0209100000	4008190055493	A.29	QB 75/6.2/9/WI	0526400000	4008190099923	I.13
MF 10/5 MC FW 51-100	1681080051	4008190899158	K.13	P 18/20 D02 BL SAKS5	0361800000	4008190106249	B.27	QL 10 SAK10	0470600000	4008190127992	I.9
MF 10/5 MC GS PE	1681231187	4008190935375	K.13	P 18/20 D02 BL SAKS5	0361800000	4008190106249	A.29	QL 10 SAK16	0471000000	4008190150761	I.9
MF 10/5 MC GW PE	1681191187	4008190929534	K.13	P 18/25 D02 GE SAKS5	0361900000	4008190091101	B.27	QL 10 SAK2.5	0338100000	4008190189426	I.10
MF 10/5 MC NEUTRAL	1677160000	4008190475505	K.13	P 18/25 D02 GE SAKS5	0361900000	4008190091101	A.29	QL 10 SAK2.5	0338100000	4008190189426	I.9
MF 10/5 MC SONDERDRUCK	1677170000	4008190475512	K.13	P 18/35 D02 SW SAKS5	0362000000	4008190070175	B.27	QL 10 SAK3	0338600000	4008190106133	I.9
MF 10/6 MC FS 1-50	1681360001	4008190322779	K.13	P 18/35 D02 SW SAKS5	0362000000	4008190070175	A.29	QL 10 SAK3S	0338600000	4008190106133	I.11
MF 10/6 MC FS 101-150	1681360101	4008190322793	K.13	P 18/50 D02 WS SAKS5	0362100000	4008190081874	A.29	QL 10 SAK3SN	0565200000	4008190174286	I.9
MF 10/6 MC FS 151-200	1681360151	4008190322809	K.13	P 18/50 D02 WS SAKS5	0362100000	4008190081874	B.27	QL 10 SAK4	0338200000	4008190107413	I.10
MF 10/6 MC FS 51-100	1681360051	4008190322786	K.13	PJ-Clean Unit	4062150000	032248297078	K.19	QL 10 SAK4	0338200000	4008190107413	I.10
MF 10/6 MC FSZ 1-10	1681370001	4008190943936	K.13	POSC M3X20 PA/NA	0451300000	4008190128265	I.17	QL 10 SAK6N	0338300000	4008190176679	I.10
MF 10/6 MC FW 1-50	1681240001	4008190944063	K.13	PPT/35	3835020000	4008190971885	D.9	QL 10 SAK6N	0338300000	4008190176679	I.21
MF 10/6 MC FW 101-150	1681240101	4008190944087	K.13	PrintJet II 115V	1858980000	03224841002	K.19	QL 10 SAK6N	0338300000	4008190176679	I.9
MF 10/6 MC FW 151-200	1681240151	4008190944094	K.13	PrintJet II 230V	1858990000	032248410811	K.19	QL 10 SAKS1	0338800000	4008190127039	B.27
MF 10/6 MC FW 51-100	1681240051	4008190944070	K.13	PS 2.0 MC	0310000000	4008190000059	I.14	QL 10 SAKS1	0338800000	4008190127039	B.27
MF 10/6 MC FWZ 1-10	1681260001	4008190944339	K.13	PS 2.0 OR	0293800000	4008190042356	I.14	QL 10 SAKS2	0338900000	4008190105723	B.27
MF 10/6 MC FWZ 5-10	1681271187	4008190935856	K.13	PS 2.3 RT	0180400000	4008190060121	I.14	QL 10 SAKS2	0338900000	4008190105723	I.9
MF 10/6 MC GS PE	1681391187	4008190935870	K.13	PS 2.3 RT	0180400000	4008190060121	E.2	QL 10 SAKS4	0339000000	4008190025335	I.9
MF 10/6 MC GW L1	1681341075	4008190943677	K.13	PS 2.3 RT	0180400000	4008190060121	E.3	QL 15 SAK6N	0221200000	4008190042110	I.21
MF 10/6 MC GW L2	1681341076	4008190943684	K.13	PS 4 F.STB 4	0296000000	4008190074043	I.14	QL 2 DLI	0297200000	4008190057176	I.9
MF 10/6 MC GW L3	1681341077	4008190943691	K.13	PS 4 F.STB 4	0296000000	4008190074043	J.8	QL 2 SAK10	0470300000	4008190023690	I.9
MF 10/6 MC GW PE	1681351187	4008190322748	K.13	PZ 1.5	9005990000	4008190088964	J.8	QL 2 SAK10	0470300000	4008190023690	I.10
MF 10/6 MC NEUTRAL	1677220000	4008190475529	K.13	PZ 16	9012600000	4008190035440	J.6	QL 2 SAK16	0470700000	4008190182618	I.9
MF 10/6 MC SONDERDRUCK	1677230000	4008190475536	K.13	PZ 3	0567300000	4008190052423	J.8	QL 2 SAK2.5	0155900000	4008190145408	I.9
MF 12/5 MC NEUTRAL	1677180000	4008190470579	K.13	PZ 4	9012500000	4008190030920	J.8	QL 2 SAK2.5	0155900000	4008190145408	I.10
MF 12/5 MC SONDERDRUCK	1677190000	4008190470586	K.13	PZ 50	9006450000	4008190095796	J.8	QL 2 SAK35	0123600000	4008190092566	I.9
MF 5/5 MC NEUTRAL	1816250000	0322248306206	K.13	PZ 50	9006450000	4008190095796	J.6	QL 2 SAK35N	0564900000	4008190099282	I.9
MF 5/5 MC SONDERDRUCK	1816320000	0322248306602	K.13	PZ 6 HEX	9013650000	0322248065516	J.8	QL 2 SAK4	0130600000	4008190077372	I.9
MF 5/5 Mini MC NEUTRAL	1816240000	0322248306190	K.13	PZ 6 Roto	9014350000	4008190406615	J.8	QL 2 SAK4	0130600000	4008190077372	I.10
MF 5/5 Mini MC SONDRDR	1816310000	0322248306589	K.13	PZ 6 Roto	9014350000	4008190406615	J.5	QL 2 SAK6N	0194300000	4008190182854	I.10
MF 5/6 MC NEUTRAL	1816260000	0322248306183	K.13	PZ 6/5	9011460000	4008190165352	J.8	QL 2 SAK6N	0194300000	4008190182854	I.21
MF 5/6 MC SONDERDRUCK	1816330000	0322248306596	K.13	PZ 6/5	9011460000	4008190165352	J.5	QL 2 SAK6N	0194300000	4008190182854	I.9
MF 8/5 MC NEUTRAL	1677140000	4008190475482	K.13	PZ 6/5	9011460000	4008190165352	J.8	QL 2 SAK6N-SAK35	0207400000	40081900061296	I.10
MF 8/5 MC SONDERDRUCK	1677150000	4008190475499	K.13	PZ ZH 16	9013600000	0322248065523	J.8	QL 2 SAK70	0345300000	4008190008013	I.9
MF 9/5 MC NEUTRAL	1816270000	0322248306312	K.13					QL 2 SAKA10	0135500000	4008190099404	I.10
MF 9/5 MC SONDERDRUCK	1816340000	0322248306718	K.13					QL 2 SAKG28	0551200000	4008190038526	I.9
MF 9/5F MC NEUTRAL	1816280000	0322248306329	K.13					QL 2 SAKS1	0191400000	4008190123130	B.27
MF 9/5F MC SONDERDRUCK	1816350000	0322248306725	K.13	Q 10 AKZ1.5	0368500000	4008190159481	E.2	QL 2 SAKS1	0191400000	4008190123130	I.9
MF 9/6 MC NEUTRAL	1816290000	0322248306336	K.13	Q 10 AKZ2	0368500000	4008190159481	I.11	QL 2 SAKS2	0207800000	4008190144364	I.9
MF 9/6 MC SONDERDRUCK	1816360000	0322248306732	K.13	Q 10 AKZ4SS	0368600000	4008190056766	E.3	QL 2 SAKS2	0207800000	4008190144364	B.27
MK 10/14	0370160000	4008190101428	F.3	Q 10 AKZ4SS	0368900000	4008190065744	I.11	QL 2 SAKS4	0328000000	4008190071165	I.9
MK 2/12	0241260000	4008190026738	F.2	Q 10 DLI	1313100000	4008190167622	I.11	QL 3 DLI	0297300000	4008190034634	I.9
MK 3/10	0274620000	4008190117559	F.2	Q 10 SAK10	0457400000	4008190016166	I.9	QL 3 SAK10	0470400000	4008190143312	I.9
MK 3/10/E	7906190000	4008190576394	F.6	Q 10 SAK16	0457800000	4008190082512	I.9	QL 3 SAK16	0470800000	4008190011574	I.9
MK 3/11/E	7906200000	4008190576400	F.6	Q 10 SAK2.5	0368700000	4008190107796	I.9	QL 3 SAK2.5	0156000000	4008190027360	I.9
MK 3/12	0243520000	4008190072834	F.2	Q 10 SAK4	0368800000	4008190049478	I.9	QL 3 SAK2.5	0156000000	4008190027360	I.10
MK 3/12/E	7906210000	4008190576417	F.6	Q 10 SAK6N	0457000000	4008190153762	I.21	QL 3 SAK35	0123700000	4008190182526	I.9
MK 3/2	0273820000	4008190142117	F.2	Q 10 SAK6N	0457000000	4008190153762	I.9	QL 3 SAK35N	0565000000	4008190076597	I.9
MK 3/2/E	7906110000	4008190576318	F.6	Q 2 AKZ1.5	0368200000	4008190149987	I.11	QL 3 SAK4	0130700000	4008190085117	I.9
MK 3/3	0273920000	4008190104894	F.2	Q 2 AKZ1.5	0368200000	4008190149987	E.2	QL 3 SAK6N	0194400000	4008190063351	I.9
MK 3/3/E	7906120000	4008190576325	F.6	Q 2 AKZ4	0336400000	4008190037680	I.9	QL 3 SAK6N	0194400000	4008190063351	I.10
MK 3/4	0274020000	4008190020712	F.2	Q 2 AKZ4	0336400000	4008190037680	I.11	QL 3 SAK6N	0194400000	4008190063351	I.21
MK 3/4/E	7906130000	4008190576332	F.6	Q 2 AKZ4SS	0336400000	4008190037680	E.3	QL 3 SAK70	0167000000	4008190001018	I.9
MK 3/5	0274120000	4008190010607	F.2	Q 2 DLI	0369000000	4008190143589	I.11	QL 3 SAKG28	0407600000	4008190038328	I.9
MK 3/5/E	7906140000	4008190576349	F.6	Q 2 SAK10	1312500000	4008190039837	I.11	QL 3 SAKS1	0191500000	4008190036881	B.27
MK 3/6	0274220000	4008190153847	F.2	Q 2 SAK16	0457100000	4008190103545	I.9	QL 3 SAKS1	0191500000	4008190036881	I.9
MK 3/6/E	7906150000	4008190576356	F.6	Q 2 SAKK16	0457500000	4008190055349	I.9	QL 3 SAKS2	0207900000	4008190047795	B.27
MK 3/7	0274320000	4008190187507	F.2	Q 2 SAK16	0367700000	4008190033842	I.9	QL 3 SAKS2	0207900000	4008190047795	I.9
MK 3/7/E	7906160000	4008190576363	F.6	Q 2 SAK6N	0456700000	4008190150044	I.21	QL 3 SAKS4	0328100000	4008190097639	I.9
MK 3/8	0274420000	4008190185015	F.2	Q 2 SAK6N	0456700000	4008190150044	I.9	QL 4 SAK10	047050000		

Type	Order No.	EAN-No.	Page	Type	Order No.	EAN-No.	Page	Type	Order No.	EAN-No.	Page
QVS 2 SAKT1+2	0307300000	4008190036140	L.20	SAK 4 SS/35 6.3/2.8	0630460000	4008190098599	A.38	SAKS 1/32 G20 GL 230VAC	0306120000	4008190038311	B.27
QVS 2/S SAKT1+2	0358460000	4008190157937	L.20	SAK 4/35	0443660000	4008190019990	A.3	SAKS 1/32 G20 GL 230VAC	0306120000	4008190038311	B.22
QVS 3 SAKT1+2	0329300000	4008190084714	L.20	SAK 4/35 BL	0443680000	4008190003869	A.3	SAKS 1/32 G20 LD 24VAC	1111220000	4008190138684	B.22
QVS 4 SAKT1+2	0307400000	4008190091941	L.20	SAK 4/35 KRIG	0443620000	4008190095642	A.7	SAKS 1/32 G20 LD 24VAC	1111220000	4008190138684	B.27
QVSK 2 SAKT1	1670360000	4008190431242	L.20	SAK 4/35 KRIG/BL	0443670000	4008190126186	A.7	SAKS 1/32 G20 LD 24VDC	0371420000	4008190074319	B.22
				SAK 4/EN	0467460000	4008190002749	C.2	SAKS 1/32 G20 LD 24VDC	0371420000	4008190074319	B.27
				SAK 4/EN BL	0467480000	4008190065669	C.2	SAKS 1/32 G25 GL 230VAC	0309320000	4008190086848	B.27
				SAK 6/35	0380560000	4008190134648	A.3	SAKS 1/32 G25 GL 230VAC	0309320000	4008190086848	B.23
				SAK 6/35 BL	0380580000	4008190029050	A.3	SAKS 1/35 G20 GB 24VDC	0173220000	4008190073459	B.27
				SAK 6/35 KRIG	0380520000	4008190007300	A.8	SAKS 1/35 G20 GL 115VAC	8068330000	4008190464523	A.24
				SAK 6/35 KRIG/BL	0380570000	4008190040642	A.8	SAKS 1/35 G20 GL 115VAC	8068330000	4008190464523	B.27
				SAK 6/EN	0212860000	4008190065553	C.3	SAKS 1/35 G20 GL 230VAC	0199920000	4008190061012	A.24
				SAK 6/EN BL	0212880000	4008190107147	C.3	SAKS 1/35 G20 GL 230VAC	0199920000	4008190061012	B.27
				SAK 6N	0193260000	4008190031893	B.3	SAKS 1/35 G20 LD 24VAC	1111320000	4008190175436	A.24
				SAK 6N BL	0193280000	4008190020644	B.3	SAKS 1/35 G20 LD 24VAC	1111320000	4008190175436	B.27
				SAK 6N KRIG	0193220000	4008190098285	B.7	SAKS 1/35 G20 LD 24VDC	0225820000	4008190057626	A.24
				SAK 6N KRIG/BL	0193270000	4008190450380	B.7	SAKS 1/35 G20 LD 24VDC	0225820000	4008190057626	B.27
				SAK 70 KRIG	0340820000	4008190080754	B.9	SAKS 1/35 G20 LD 48VAC	0214020000	4008190168100	A.24
				SAK 70 KRIG/BL	0340870000	4008190053321	B.9	SAKS 1/35 G20 LD 48VAC	0214020000	4008190168100	B.27
				SAK 70/35	0139160000	4008190088552	A.6	SAKS 1/35 G25 GL 230VAC	0198620000	4008190185992	B.27
				SAK 95 KRIG	0550520000	4008190077389	B.9	SAKS 1/35 G25 GL 230VAC	0198620000	4008190185992	A.25
				SAK 95/35 KRIG	0662220000	4008190140991	A.10	SAKS 1/35/G25	0501620000	4008190111229	A.24
				SAKA 10	0134120000	4008190083380	B.30	SAKS 1/35/G25	0501520000	4008190047801	A.25
				SAKB 10	0134920000	4008190143138	B.30	SAKS 1/G20	0191220000	4008190095860	B.22
				SAKC 10 2STB	0324120000	4008190049959	B.19	SAKS 1/G25	0191120000	4008190121129	B.23
				SAKC 10 STB/RE	0324020000	4008190055523	B.19	SAKS 2	0206820000	4008190048327	B.24
				SAKC 10/35 1STB4 KRIG	1404520000	4008190170400	A.20	SAKS 2/35	1366720000	4008190047818	A.26
				SAK 4 KRIG	0340720000	4008190160609	B.19	SAKS 3 G/5X30 500V	0297520000	4008190128401	B.23
				SAK 4/35	0357520000	4008190185077	A.20	SAKS 3 GZ/6.3X32	0248920000	4008190109738	B.23
				SAK 4/35 BL	0357570000	4008190054913	A.20	SAKS 3/35 G/6.3X30 500V	0328920000	4008190113339	A.25
				SAKD 2.5/35	0288860000	4008190136284	A.2	SAKS 3/35 GZ/6.3X32	0667520000	4008190093976	A.25
				SAKD 2.5/35 BL	0268880000	4008190061951	A.2	SAKS 4	0321320000	4008190005313	B.24
				SAKD 2.5N	0215560000	4008190163433	B.2	SAKS 4 USA	0162220000	4008190016586	B.25
				SAKD 2.5N BL	0215580000	4008190082086	B.2	SAKS 4/32 E14 GL 480VAC	0102120000	4008190131326	B.27
				SAKE 35	0144400000	4008190122744	B.14	SAKS 4/32 GL 115VAC	0101820000	4008190138264	B.27
				SAKE 70/32	0213200000	4008190088712	B.15	SAKS 4/35	0501820000	4008190090166	A.26
				SAKG 28 I	0170020000	4008190152000	B.52	SAKS 4/35 USA	0178220000	4008190095987	A.27
				SAKG 28 II	0170320000	4008190126247	B.53	SAKS 5 380AC	0359420000	4008190036010	B.25
				SAKG 28 II/GW	0185020000	4008190022822	B.53	SAKS 5/35	0502120000	4008190142360	A.27
				SAKG 28 III	0170820000	4008190039356	B.54	SAKS 6/GZ 500AC	0531820000	4008190129808	B.27
				SAKG 32 I	0286620000	4008190116750	B.54	SAKS 7/G20	0573120000	4008190071399	B.27
				SAKG 32 II	0170420000	4008190011369	B.55	SAKS 7/G25	0576120000	400819001498	B.27
				SAKG 32 II/GW	0185120000	4008190014568	B.55	SAKT 1/35/DU1	0105820000	4008190044176	A.32
				SAKG 32 III	0286720000	4008190081010	B.55	SAKT 1/35/LT	0105420000	4008190014036	A.32
				SAKG 32/35 I	0637120000	4008190111496	A.42	SAKT 1/35/LT STB	0105620000	4008190079338	A.32
				SAKG 32/35 II	0637320000	4008190018276	A.43	SAKT 1/35/QT1	0105720000	4008190116439	A.33
				SAKG 32/35 II/GW	0637420000	4008190070564	A.43	SAKT 1/35/QT2	0124620000	4008190093855	A.33
				SAKG 32/35 III	0637220000	4008190083366	A.44	SAKT 1/DU1	0195620000	4008190100391	B.31
				SAKG 40 I	0286820000	4008190163273	B.56	SAKT 1/DU2	0550420000	4008190140373	B.31
				SAKG 40 II	0170520000	4008190049911	B.57	SAKT 1/LT	0269120000	4008190185978	B.31
				SAKG 40 II/GW	0185220000	4008190088408	B.57	SAKT 1/LT STB14/4	0437920000	4008190163549	B.31
				SAKG 40 III	0286920000	4008190137847	B.57	SAKT 1/QT1	0269320000	4008190120380	B.31
				SAKG 40/35 I	0637520000	4008190014872	A.45	SAKT 1/QT2	0494820000	4008190039585	B.31
				SAKG 40/35 II	0637720000	4008190101367	A.45	SAKT 2/35/LT 4STB	0106020000	4008190182892	A.33
				SAKG 40/35 II/GW	0637820000	4008190052409	A.45	SAKT 2/35/LT/STB	0105920000	4008190126162	A.33
				SAKG 40/35 III	0637620000	4008190112189	A.46	SAKT 2/LT 4STB	0437720000	4008190040291	B.32
				SAKG 46 I/AL	1287920000	4008190060372	B.59	SAKT 2/LT O.STB	0445420000	4008190095438	B.32
				SAKG 46 II	0170620000	4008190170592	B.58	SAKT 2/LT STB	0330620000	4008190048433	B.32
				SAKG 46 II/GW	0185320000	4008190125257	B.58	SAKT 4/35/LT O.STB	1272420000	4008190168483	A.33
				SAKG 46/35 II	0637920000	4008190122645	A.46	SAKT 4/35/LT STB2.0	1272520000	4008190061838	A.33
				SAKG 46/35 II/GW	0638020000	4008190080161	A.47	SAKT 4/DU O.STB	0246320000	4008190034092	B.33
				SAKG 54 I	0170720000	4008190064044	B.59	SAKT 4/LT 1STB2.0	0254220000	4008190120351	B.32
				SAKG 54 II/GW	0185420000	4008190052577	B.59	SAKT 4/LT O.STB	0254120000	4008190130138	B.32
				SAKG 54/35 I	0638120000	4008190068646	A.47	SAKT 4/LT STB2.0	0310320000	4008190181796	B.32
				SAKG 54/35 II/GW	0638220000	4008190092443	A.47	SCHT 14/6	1269060000	4008190051396	K.16
				SAKG 70 II/GW	0150420000	4008190126841	B.56	SCHT 5	0292460000	4008190105440	K.15
				SAKG 70/35 II/GW	0636620000	4008190157876	A.44	SCHT 5 S	1631930000	4008190206680	K.15
				SAKH 10 CUN/EP/SW	1104700000	4008190175092	D.7	SCHT 7	0517960000	4008190001742	K.15
				SAKH 10 EP/SW	0126700000	4008190033156	D.7	SCHT 9/4	1278460000	4008190089300	K.16
				SAKH 35 EP/SW	1596240000	4008190093570	D.7	SD 0,4x2,0x60	9037160000	032248171613	J.18
				SAKH 35/M.AP CUN/EP/SW	1593540000	4008190185725	D.7	SD 0,4x2,5x75	9090300000	032248266944	J.18
				SAKH 6 EP/SW	0126600000	4008190121471	D.6	SD 0,5x3,0x80	9008320000	032248056262	J.18
				SAKK 10	9502610000	4008190050592	D.3	SD 0,6x3,5x100	9008330000	032248056286	J.15
				SAKK 10 KER/WS	1598090000	4008190185565	D.3	SD 0,6x3,5x100	9008330000	032248056286	J.18
				SAKK 4	9502600000	4008190050585	D.2	SD 0,6x3,5x200	9010110000	032248300754	J.18
				SAKK 4 KER/WS	1598080000	4008190020729	D.2	SD 0,8x4,0x100	9008340000	032248056293	J.18
				SAKR	0412160000	4008190016418	B.16	SD 0,8x4,5x125	9090200000	032248266883	J.18
				SAKR 15	0412760000	4008190035310	E.3	SD 1,0x5,5x150	9008350000	032248056316	J.18
				SAKR 15 2STB	0412860000	4008190018290	E.3	SD 1,2x6,5x150	9090100000	032248266869	J.18
				SAKR 2STB	0412260000	4008190054403	B.16	SD STK 10x175	9009710000	032248267958	J.19
				SAKR 2STB BL	0412280000	4008190096915	B.16	SD STK 8x150	9009700000	032248267941	J.19
				SAKR 2STB KRIG	0412220000	4008190049058	B.16	SDI 0,4x2,5x75	9008370000	032248056330	J.16
				SAKR BL	0412180000	4008190026745	B.18	SDI			

Type	Order No.	EAN-No.	Page	Type	Order No.	EAN-No.	Page	Type	Order No.	EAN-No.	Page	
SDIT 25	9009670000	4032248267866	J.16	STB 30.5 IH/BL	0341200000	4008190044077	L.15	V	VH 12.5/5/3.5 SAK10-2.5	0300800000	4008190056179	L.10
SDIT 30	9009680000	4032248267873	J.16	STB 30.5 IH/GE	0341500000	4008190130961	L.20		VH 12/4.9/3.3 SAK6N	0249000000	4008190129507	L.10
SDIT 40	9009690000	4032248267880	J.16	STB 30.5 IH/GE	0341500000	4008190130961	L.15		VH 12/4.9/3.3 SAK6N	0249000000	4008190129507	L.10
SDIT 8	9201940000	4032248478965	J.16	STB 30.5 IH/GN	0341400000	4008190080893	L.20		VH 13.5/4.9/3.3 SAK4	0248500000	4008190022723	L.9
SDIZ0,6X3,5X100	9008450000	4032248056446	J.24	STB 30.5 IH/GN	0341100000	4008190083960	L.20		VH 13.5/4.9/3.3 SAK4	0248500000	4008190022723	L.9
SDIZ0,8X4,0X100	9008460000	4032248056453	J.24	STB 30.5 IH/GR	0341100000	4008190083960	L.15		VH 13.5/4.9/3.3 SAK4	0248500000	4008190022723	L.9
SDK PH0	9008470000	4032248056460	J.18	STB 30.5 IH/GR	0341300000	4008190157852	L.15		VH 16/5/3.5 SAK10-35	0309700000	4008190037024	L.10
SDK PH1	9008480000	4032248056477	J.18	STB 30.5 IH/RT	0341300000	4008190157852	L.15		VH 17/8/5 SAK35	0267000000	4008190146986	L.10
SDK PH2	9008490000	4032248056484	J.18	STB 30.5 IH/RT	0341300000	4008190157852	L.15		VH 17/8/5 SAK35	0267000000	4008190146986	L.10
SDK PH3	9008500000	4032248056491	J.18	STB 30.5 IH/SW	0341000000	4008190015299	L.20		VH 19/5/3.5 SAK4-16	0285100000	4008190189297	L.12
SDK PZ0	9008520000	4032248056514	J.18	STB 30.5 IH/SW	0341000000	4008190015299	L.15		VH 19/6/4.2 SAKT1	0318000000	4008190059460	L.21
SDK PZ1	9008530000	4032248056521	J.18	STB 30.5 IH/VI	0341600000	4008190026035	L.15		VH 24.5/8/5 SAK35	0298700000	4008190070809	L.12
SDK PZ2	9008540000	4032248056538	J.18	STB 30.5 IH/VI	0341600000	4008190026035	L.20		VH 27/5/3.5 SAK10-35	0309400000	4008190143176	L.10
SDK PZ3	9008550000	4032248056545	J.18	STB 35 IH/BL	0388700000	4008190082383	L.15		VH 30.5/11/5.5 SAK70	0345500000	4008190100698	L.9
SDS 2,5-5,5/PH1/2	9009740000	4032248267996	J.19	STB 35 IH/BL	0388700000	4008190082383	L.20		VH 35/11/5.5 SAK95	0551100000	4008190052669	L.9
SDS TR8-30	9009720000	4032248267965	J.19	STB 35 IH/GE	0389000000	4008190396985	L.15		VH 4.5/5/3.5 SAK6N-16	0303200000	4008190165963	L.10
SDTR 10	9009180000	4032248267156	J.18	STB 35 IH/GE	0389000000	4008190396985	L.20		VH 5/4/2.8 AKZ4	0296800000	4008190080000	L.9
SDTR 15	9009170000	4032248267149	J.18	STB 35 IH/GN	0388900000	4008190010409	L.15		VH 8/4.9/3.3 SAK2.5	0266700000	4008190152031	L.9
SDTR 20	9009160000	4032248267125	J.18	STB 35 IH/GN	0388900000	4008190010409	L.20		VH 8/4.9/3.3 SAK2.5	0266700000	4008190152031	L.9
SDTR 25	9009150000	4032248267118	J.18	STB 35 IH/GR	0388600000	4008190140656	L.20		VL 2 SAK16/SAKA	0135800000	4008190132088	L.12
SDTR 30	9009140000	4032248267101	J.18	STB 35 IH/GR	0388600000	4008190140656	L.15		VL 2 SAK35	0124000000	4008190120108	L.12
SDTR 8	9009190000	4032248267163	J.18	STB 35 IH/RT	0388800000	4008190177485	L.15		VL 2 SAK4	0197000000	4008190000271	L.12
SH 1	0299860000	4008190135133	H.3	STB 35 IH/RT	0388800000	4008190177485	L.20		VL 2 SAK6/10/SAKB	0135900000	4008190036409	L.12
SH 2	0494920000	4008190007584	L.12	STB 35 IH/SW	0388500000	4008190089726	L.20		VL 2 SAK6N/SAKT	0194700000	4008190148027	L.12
SH 2 S	0641720000	4008190166304	H.3	STB 35 IH/SW	0388500000	4008190089726	L.15		WAD 12 M. BLITZZEICHEN	1055960000	4008190154080	K.16
SH 3	0556660000	4008190123086	H.3	STB 35 IH/VI	0389100000	4008190137755	L.20		WAD 12 NEUTRAL	1056260000	4008190083205	K.16
SK 10,0x125	9009070000	4032248267026	J.18	STB 35 IH/VI	0389100000	4008190137755	L.15		WAD 27 M. BLITZZEICHEN	1062860000	4008190127732	K.16
SK 11,0x125	9009060000	4032248267019	J.18	STB 5.5/D3.7/2.3/M3 ZB	0122700000	4008190036665	L.15		WAD 27 NEUTRAL	1062960000	4008190148225	K.16
SK 12,0x125	9009050000	4032248267002	J.18	STB 6/D3.7/2.3/M2 SAKR	0379400000	4008190023478	L.15		WAD 5 MIT BLITZZEICHEN	1053460000	4008190102586	K.16
SK 13,0x125	9009040000	4032248266968	J.18	STB 6/D3.9/2.3/M2.5 ZB	0132020000	4008190154311	L.15		WAD 5 NEUTRAL	1056600000	4008190048099	K.16
SK 5,0x125	9009130000	4032248267095	J.18	STB 7.5/D6.4/M4 ZB/SAKB	0130000000	4008190136598	L.15		WAD 8 MIT BLITZZEICHEN	1053560000	4008190085537	K.16
SK 5,5x125	9009120000	4032248267088	J.18	STB 7/D4.2.3/M3 ZB/SAKC	0358500000	4008190049195	L.15	WAD 8 NEUTRAL	1056160000	4008190024888	K.16	
SK 6,0x125	9009110000	4032248267071	J.18	STB 8.5/5/2.3/M3 SAK2.5	0280600000	4008190023188	L.15	WAW 1 NEUTRAL	9004500000	4008190053925	J.3	
SK 7,0x125	9009100000	4032248267064	J.18	STB 8.5/D4.5/2/M3 SAKT4	0244600000	4008190103828	L.15	WAW 2	9004510000	4008190111182	J.3	
SK 8,0x125	9009090000	4032248267057	J.18	STB 8.5/D4.2/3/M2.5 AKZ	0215700000	4008190184872	E.3	WEW 32/1	1067600000	4008190099657	H.10	
SK 9,0x125	9009080000	4032248267040	J.18	STB 8.5/D4.2/3/M2.5 AKZ	0215700000	4008190184872	E.2	WEW 35/1	1059000000	4008190172282	H.3	
SK S20/SAKS1	0282100000	4008190004606	B.27	STB 8.5/D4.2/3/M2.5 AKZ	0215700000	4008190184872	L.15	WEW 35/2	1059000000	4008190172282	H.10	
SK GAKS1/G25	0282000000	4008190078492	B.27	STRIPAX	9005000000	4008190072506	J.4	WEW-35/2	1061200000	4008190030230	H.3	
SK WSD-S 1,5-10,0	9008850000	4032248266609	J.20	STRIPAX 16	9005610000	4008190183875	J.4	WEW-35/2	1061200000	4008190030230	H.10	
SK-S 2,0-8,0	9008860000	4032248266616	J.20	STRIPAX PLUS 2,5	9020000000	4008190067267	J.8	WGB 5 ABDG.M.GRUPPENBEZ	1050760000	4008190072865	K.16	
SK-S 2,0-8,0 MR	9008870000	4032248266623	J.20	swifty	9006000000	4032248257409	J.15	WGB 8 ABDG.M.GRUPPENBEZ	1050960000	4008190076986	K.16	
SK.SCHLÜSSEL SW 4 D 911	0048510000	4008190117429	J.24	SWIFTY SET	9006060000	4032248257638	J.15	WK IK PH 0	9918460000	4032248388820	J.23	
SK.SCHLÜSSEL SW 6 D6911	0407900000	4008190166465	J.24	System 11+1	9009750000	4032248286809	J.19	WK IK PH 1	9918470000	4032248388837	J.23	
SK.SCHLÜSSEL SW 8 D6911	0235000000	4008190167875	J.24	System 11+1 Secur.	9009760000	4032248268016	J.19	WK IK PH 2	9918480000	4032248388844	J.23	
SKI 10,0x126	9008940000	4032248266739	J.16	TA 1	0535860000	4008190111915	L.14	WK IK PH 2	9918490000	4032248388851	J.23	
SKI 11,0x125	9008930000	4032248266722	J.16	TBS 2	1287860000	4008190040208	L.17	WK IK PZ 1	9918500000	4032248388868	J.23	
SKI 13,0x125	9008920000	4032248266715	J.16	Tintenpatrone PrintJet	1797460000	4032248238682	K.19	WK IK PZ 2	9918510000	4032248388875	J.23	
SKI 5,0x129	9009000000	4032248266814	J.16	Tintentank PrintJet II	1858920000	4032248410651	K.19	WK K PH 0	9918570000	4032248388943	J.22	
SKI 5,5x128	9008990000	4032248266791	J.16	Toner für Speedmarking-Laser TR-S 9-40	1770070000	4032248117468	K.18	WK K PH 1	9918580000	4032248388950	J.22	
SKI 6,0x128	9008980000	4032248266784	J.16	TS 15x5 1M/ST/ZN	9008880000	4032248266630	J.20	WK K PH 1	9918590000	4032248388967	J.22	
SKI 7,0x127	9008970000	4032248266777	J.16	TS 15x5 2M/AL/BK	0514210000	4008190050547	H.8	WK K PH 2	9918600000	4032248388974	J.22	
SKI 8,0x127	9008960000	4032248266760	J.16	TS 15x5 2M/ST/ZN	0134700000	4008190129026	H.8	WK K PH 2	9918610000	4032248388981	J.22	
SKI 9,0x126	9008950000	4032248266753	J.16	TS 15x5 2M/ST/ZN	0514200000	4008190172428	H.8	WK K PZ 1	9918620000	4032248388988	J.22	
SMSE WSH U1	1083900000	4008190065515	G.7	TS 15x5/LL 1M/ST/ZN	0117510000	4008190111298	H.8	WK K PZ 2	9918630000	4032248388995	J.22	
Snap Mark I	1805880000	4032248273614	K.14	TS 15x5/LL 2M/AL/BK	0217900000	4008190119034	H.8	WK S 0,4 x 2,5	9918500000	4032248388912	J.22	
SO SFH1	0401460000	4008190188092	H.3	TS 15x5/LL 2M/ST/ZN	0117500000	4008190150662	G.11	WK S 0,5 x 3,0	9918530000	4032248388919	J.22	
SP 15	3896100000	4008190857851	G.9	TS 32x15 1M/ST/ZN	1802690000	4032248257201	G.11	WK S 0,6 x 3,5	9918540000	4032248388926	J.22	
SP 20	3896200000	4008190850234	G.9	TS 32x15 2M/AL/BK	0122810000	4008190078935	H.8	WK S 0,8 x 4,0	9918550000	4032248388933	J.22	
SP 30	3896300000	4008190850241	G.9	TS 32x15 2M/ST/ZN	0169300000	4008190105167	H.8	WK S 1,0 x 5,5	9918560000	4032248388940	J.22	
SPEEDMARKING-LASER	1767090000	4032248112916	K.18	TS 32x15/LL 1M/ST/ZN	0122800000	4008190066307	B.27	WK SI 0,4 x 2,5	9918420000	4032248388937	J.23	
SS M3 D 128-A 3	0164400000	4008190035914	L.10	TS 32x16.2 2M/AL/BK	0364300000	4008190026806	H.8	WK SI 0,5 x 3,0	9918430000	4032248388944	J.23	
SS M4 D 128-A 4	0136400000	4008190118143	L.10	TS 35x15 1M/ST/ZN	0236410000	4008190157708	H.8	WK SI 0,6 x 3,5	9918440000	4032248388951	J.23	
SSCH 10X3X1000 CU/SN	0348900000	4008190024802	G.4	TS 35x15 2M/ST/ZN	0236400000	4008190114558	H.9	WK SI 0,8 x 4,0	9918450000	4032248388958	J.23	
SSCH 10X3X1000 CU/SN	0348900000	4008190024802	G.6	TS 35x15/2.3 2M/AL/BK	1848290000	4032248385614	H.9	WK SI 1,0 x 5,5	9918460000	4032248388965	J.23	
SSCH 10X3X1000 CU/SN	0348900000	4008190024802	G.5	TS 35x15/2.3 2M/ST/ZN	0270100000	4008190105136	H.9	WS 10/3,5 NEUTRAL	1070290000	4008190430368	K.11	
SSCH 10X3X1000 CU/SN	0348900000	4008190024802	H.2	TS 35x15/2.3 2M/ST/ZN	0514400000	4008190175283						

Type	Order No.	EAN-No.	Page
WS 14/5 MC neutral	1768090000	4032248106271	K.11
WS 15/5 MC BEDRUCKT	1609890000	4008190456672	K.11
WS 15/5 MC NEUTRAL	1609880000	4008190203504	K.11
WS 8/5 MC BEDRUCKT	1640750000	4008190456627	K.11
WS 8/5 MC NEUTRAL	1640740000	4008190279103	K.11
WS 8/5 Sonderdr. Laser	1773360000	4032248140961	K.10
WSH 1	1068700000	4008190118389	G.6
WSH 18 MT	1083100000	4008190053246	G.7
WSH 19 MT	1083200000	4008190059538	G.7
WSH 20 MT	1752950000	4008190022624	G.7
WSH 3/H/N	1715970000	4008190353100	G.6
WSH 4 MT	1079900000	4008190379254	G.9
WSH 5	1080100000	4008190965143	G.6
WSH 6	1080200000	4008190965150	G.6
WTW EN	1058800000	4008190140175	A.34
WTW EN	1058800000	4008190140175	B.34

Z

ZB 10 F.10X3/10X5/10X10	1261300000	4008190180201	H.4
ZB 16 ZKSC	0316600000	4008190145989	H.4
ZB 16/6	0556800000	4008190007751	H.4
ZB 16/6K BL	0569680000	4008190024369	H.5
ZB 16/6K GE/GN	0569660000	4008190043681	H.5
ZB 16K BL	0502880000	4008190014186	H.5
ZB 16K GE/GN	0502860000	4008190188795	H.5
ZB 16K SW	0502810000	4008190332563	H.5
ZB 35/M6X16	0266500000	4008190102814	H.4
ZB 35K BL M6X16	0502680000	4008190004385	H.5
ZB 35K GE/GN M6X16	0502660000	4008190052294	H.5
ZB 35K SW M6X16	0502610000	4008190332587	H.5
ZB 4	0316500000	4008190061999	H.4
ZB 4/6	0556700000	4008190188412	H.4
ZB 4/6K BL	0565480000	4008190086831	H.5
ZB 4/6K GE/GN	0565460000	4008190032609	H.5
ZB 4G BL	0322180000	4008190050504	H.5
ZB 4G EX E GN/GE	0322160000	4008190014278	H.5
ZB 4G SW	0322110000	4008190189310	H.5
ZB 4K BL	0475380000	4008190010942	H.5
ZB 4K GE/GN	0475360000	4008190188047	H.5
ZBE 6	0459500000	4008190032692	H.4
ZBE 6K BL	0525980000	4008190060886	H.5
ZBE 6K GE/GN	0525960000	4008190145026	H.5
ZBE 6K SW	0525910000	4008190977054	H.5
ZEW	9540000000	4008190956264	H.10
ZEW 15	7920340000	4032248238910	H.10
ZEW 35/2	8630740000	4032248348916	H.10
ZF 4 S	1814680000	4032248302949	H.5
ZF 4 S BL	1814660000	4032248302956	H.5
ZF 4 S GN/GE	1814670000	4032248302963	H.5
ZGB 15	1636530000	4008190297053	K.17
ZGB 30	1611930000	4008190002251	K.17
ZS 10/5 MC BEDRUCKT	1610010000	4008190263423	K.11
ZS 10/5 MC NEUTRAL	1610000000	4008190263171	K.11
ZS 12/6 BEDRUCKT	1610030000	4008190456689	K.11
ZS 12/6 MC NEUTRAL	1610020000	4008190444600	K.11
ZS 15/5 MC BEDRUCKT	1646640000	4008190456696	K.11
ZS 15/5 MC NEUTRAL	1646630000	4008190401214	K.11
ZS 2.3/4	0249600000	4008190022785	I.14
ZU 1	0240600000	4008190014940	I.5

Order No.	EAN No.	Type	Page
-----------	---------	------	------

005000000

0053160000	4008190860943	DK 4/35 RC 220R/220N	A.57
------------	---------------	----------------------	------

010000000

0101700000	4008190069254	TST 2/M6	H.11
0101820000	4008190138264	SAKS 4/32 GL 115VAC	B.27
0102120000	4008190131326	SAKS 4/32 E14 GL 480VAC	B.27
0103300000	4008190023348	BFSC M4X9T	H.3
0103300000	4008190023348	BFSC M4X9T	I.9
0105100000	4008190394875	AP SAK4-10 DB	I.6
0105160000	4008190042677	AP SAK4-10 OR	I.6
0105360000	4008190100452	AP ASK1 OR	I.6
0105420000	4008190014056	SAKT 1/35/LT	A.32
0105620000	4008190079338	SAKT 1/35/LT STB	A.32
0105720000	4008190116439	SAKT 1/35/QT1	A.33
0105820000	4008190044176	SAKT 1/35/DU1	A.32
0105920000	4008190126162	SAKT 2/35/LT/STB	A.33
0106020000	4008190182892	SAKT 2/35/LT 4STB	A.33
0107160000	4008190188726	SAK 2.5/TC AL	B.34
0107260000	4008190113711	SAK 2.5/TC CH	B.34
0108520000	4008190154165	SAK 2.5 SW 1X1/KRG	B.47
0108560000	4008190184032	SAK 2.5 SW 1X1	B.39
0108960000	4008190020934	AKZ 2.5 K SW U/V 1X1	E.15

011000000

0110020000	4008190047214	SAK 10 KRG	B.7
0110060000	4008190027056	SAK 10	B.3
0110070000	4008190143824	SAK 10 KRG/BL	B.7
0110080000	4008190151799	SAK 10 BL	B.3
0111750000	4008190150662	TS 15X5/LL 2M/ST/ZN	H.8
0111751000	4008190111298	TS 15X5/LL 1M/ST/ZN	H.8
0111790000	4008190125059	AP SAK4-10 RT	I.6
0111791000	4008190183707	AP SAK4-10 I	I.6
0111792000	4008190135904	AP SAK4-10 KRG	I.4
0111792000	4008190135904	AP SAK4-10 KRG	I.6
0111796000	4008190081485	AP SAK4-10	I.6
0111797000	4008190049607	AP SAK4-10 KRG/BL	I.6
0111798000	4008190171087	AP SAK4-10 BL	I.6

012000000

0122700000	4008190063865	STB 5.5/D3.7/2.3/M3 ZB	I.15
0122800000	4008190086307	TS 32X15 2M/ST/ZN	B.27
0122800000	4008190066307	TS 32X15 2M/ST/ZN	H.8
0122810000	4008190078935	TS 32X15 1M/ST/ZN	H.8
0123600000	4008190092566	QL 2 SAK35	I.9
0123700000	4008190182526	QL 3 SAK35	I.9
0123800000	4008190185390	QL 4 SAK35	I.9
0124000000	4008190120108	VL 2 SAK35	I.12
0124620000	4008190093785	SAKT 1/35/QT2	A.33
0126600000	4008190121471	SAKH 6 EP/SW	D.6
0126700000	4008190033156	SAKH 10 EP/SW	D.7
0128300000	4008190407629	SAK 4 EP/SW	D.6
0128320000	4008190024796	SAK 4 KRG	B.6
0128370000	4008190110475	SAK 4 KRG BL	B.6
0128380000	4008190113629	SAK 4 BL	B.3
0128900000	4008190084158	BFSC M3X22 PA/RT	I.17
0129100000	4008190020842	BFSC M4X32 PA/RT	I.17

013000000

0130000000	4008190136598	STB 7.5/D6/4/M4 ZB/SAKB	I.15
0130200000	4008190154431	STB 6/D3.9/2.3/M2.5 ZB	I.15
0130600000	4008190077372	QL 2 SAK4	I.9
0130600000	4008190077372	QL 2 SAK4	I.10
0130700000	4008190085117	QL 3 SAK4	I.9
0130800000	4008190173715	QL 4 SAK4	I.10
0130800000	4008190173715	QL 4 SAK4	I.9
0131700000	4008190174880	AP SAKH6-10 EP/SW	I.6
0131720000	4008190040901	AP SAKH6-10 KRG	I.6
0131730000	4008190132729	AP SAKH6-10 KRS	I.4
0132660010	4008190162399	DEK 5 FW 10-500	K.20
0132690000		DEK 5 FW FARBIG	K.20
0132961021	4008190078904	DEK 5 GS A	K.20
0132961022	4008190121631	DEK 5 GS B	K.20
0132961023	4008190162221	DEK 5 GS C	K.20
0132961024	4008190131876	DEK 5 GS D	K.20
0132961025	4008190064402	DEK 5 GS E	K.20
0132961026	4008190186357	DEK 5 GS F	K.20
0132961027	4008190046910	DEK 5 GS G	K.20
0132961028	4008190081142	DEK 5 GS H	K.20
0132961029	4008190074494	DEK 5 GS I	K.20
0132961030	4008190084073	DEK 5 GS J	K.20
0132961031	4008190177669	DEK 5 GS K	K.20
0132961032	4008190081003	DEK 5 GS L	K.20
0132961033	4008190102821	DEK 5 GS M	K.20
0132961034	4008190087883	DEK 5 GS N	K.20
0132961035	4008190071691	DEK 5 GS O	K.20
0132961036	4008190173937	DEK 5 GS P	K.20
0132961037	4008190050122	DEK 5 GS Q	K.20
0132961038	4008190080105	DEK 5 GS R	K.20
0132961039	4008190109882	DEK 5 GS S	K.20
0132961040	4008190094546	DEK 5 GS T	K.20
0132961041	4008190049164	DEK 5 GS U	K.20

Order No.	EAN No.	Type	Page
-----------	---------	------	------

0132961042	4008190123604	DEK 5 GS V	K.20
0132961043	4008190160234	DEK 5 GS W	K.20
0132961044	4008190161057	DEK 5 GS X	K.20
0132961045	4008190161125	DEK 5 GS Y	K.20
0132961046	4008190089375	DEK 5 GS Z	K.20
0133161114	4008190044121	DEK 5 FW U1-PE1	K.20
0133161115	4008190115524	DEK 5 FW U2-PE2	K.20
0133161116	4008190150389	DEK 5 FW U3-PE3	K.20
0133161117	4008190183226	DEK 5 FW U4-PE4	K.20
0133161118	4008190146146	DEK 5 FW U5-PE5	K.20
0133161119	4008190071189	DEK 5 FW U6-PE6	K.20
0133161120	4008190103767	DEK 5 FW U7-PE7	K.20
0133161121	4008190145880	DEK 5 FW U8-PE8	K.20
0133161122	4008190151416	DEK 5 FW U9-PE9	K.20
0133261150	4008190100940	DEK 5 FW X1-Z1	K.20
0133261151	4008190189228	DEK 5 FW X2-Z2	K.20
0133261152	4008190088484	DEK 5 FW X3-Z3	K.20
0133261153	4008190105204	DEK 5 FW X4-Z4	K.20
0133261154	4008190085315	DEK 5 FW X5-Z5	K.20
0133261155	4008190064518	DEK 5 FW X6-Z6	K.20
0133261156	4032248044467	DEK 5 FW X7-Z7	K.20
0133261157	4008190033231	DEK 5 FW X8-Z8	K.20
0133261158	4008190094577	DEK 5 FW X9-Z9	K.20
0133261159	4008190083052	DEK 5 FW X10-Z10	K.20
0133360001	4008190125912	DEK 6 FSZ 1-10	K.20
0133360011	4008190025557	DEK 6 FSZ 11-20	K.20
0133360021	4008190078348	DEK 6 FSZ 21-30	K.20
0133360031	4008190023850	DEK 6 FSZ 31-40	K.20
0133360041	4008190086510	DEK 6 FSZ 41-50	K.20
0133360051	4008190075774	DEK 6 FSZ 51-60	K.20
0133360061	4008190182656	DEK 6 FSZ 61-70	K.20
0133360071	4008190062934	DEK 6 FSZ 71-80	K.20
0133360081	4008190025120	DEK 6 FSZ 81-90	K.20
0133360091	4008190104719	DEK 6 FSZ 91-100	K.20
0133400000	4008190136567	STB 28.5 IH/SW SAK2.5	I.15
0134000000	4008190118945	QB 25/6.5/11.5 SAKR	E.3
0134120000	4008190083380	SAKA 10	B.30
0134220000	4008190167943	AP SAKA KRG	I.6
0134220000	4008190167943	AP SAKA KRG	I.4
0134420000	4008190084813	KS 2 O.D2	F.4
0134700000	4008190129026	TS 15X5 2M/AL/BK	H.8
0134920000	4008190143138	SAKB 10	B.30
0135200000	4008190172862	STB 13.5/D6/4/M4 SAKA10	I.15
0135500000	4008190093404	QL 2 SAKA10	I.10
0135800000	4008190132088	VL 2 SAK16/SAKA	I.12
0135900000	4008190036409	VL 2 SAK6/10/SAKB	I.12
0136400000	4008190118143	SS M4 D 128-A 4	I.10
0137320000	4008190023454	AL 1	E.12
0137400000	4008190068904	E 14/4A RS	B.26
0137400000	4008190068904	E 14/4A RS	A.28
0137500000	4008190142629	E 14/4A BR	A.28
0137500000	4008190142629	E 14/4A BR	B.26
0138000000	4008190114664	P 14/2 D01 RS SAKSA	A.27
0138000000	4008190114664	P 14/2 D01 RS SAKSA	B.29
0138100000	4008190077365	P 14/4 D01 BR SAKSA	B.27
0138100000	4008190077365	P 14/4 D01 BR SAKSA	A.29
0139160000	4008190088552	SAK 70/35	A.6

014000000

0140200000	4008190134884	STB 16/D7/4/M4 SAK35	I.15
0140320000	4008190044336	KS 4 O.D4	F.4
0140620000	4008190071769	KS 6 O.D6	F.4
0141620000	4008190053697	KS 10 O.D10	F.4
0144400000	4008190122744	SAKE 35	B.14
0146720000	4008190027995	AP SAKB/C/T KRG	I.6
0146720000	4008190027995	AP SAKB/C/T KRG	B.27
0146720000	4008190027995	AP SAKB/C/T KRG	I.4
0146760000	4008190114985	AP SAKB/C/T BE	I.6
0147100000	4008190183042	STB 17/D6/4/M4 SAKC10	I.15

015000000

0150420000	4008190126841	SAKG 70 II/GW	B.56
0150960000	4008190071981	AP SAKD2.5N	I.4
0150960000	4008190071981	AP SAKD2.5N	I.6
0150980000	4008190014797	AP SAKD2.5N BL	I.6
0155900000	4008190145408	QL 2 SAK2.5	I.9
0155900000	4008190145408	QL 2 SAK2.5	I.10
0156000000	4008190027360	QL 3 SAK2.5	I.9
0156000000	4008190027360	QL 3 SAK2.5	I.10
0156100000	4008190076443	QL 4 SAK2.5	I.10
0156100000	4008190076443	QL 4 SAK2.5	I.9
0157261187	4008190064471	DEK 5 GS PE	K.20
0157261202	4008190145774	DEK 5 GS ERDE	K.20
0157261203	4008190046415	DEK 5 GS ERDE IM KREIS	K.20
0157261235		DEK 5 GS MP	K.20
0158760000	4008190017606	AKZ 4 SF SE 6.3/2.8	E.9
0159160000	4008190146405	DK 4/32 2D 1K5	B.68

016000000

0162220000	4008190016586	SAKS 4 USA	B.25
0162520000	4008190139179	AP AKA2.5	I.6
0162570000	4008190022358	AP AKA2.5 KRG/BL	I.6
0164000000	4008190095345	TSTW 6/M6	H.11
0164400000	4008190035914	SS M3 D 128-A 3	I.10
0167000000	4008190001018	QL 3 SAK70	I.9

Order No.	EAN No.	Type	Page
-----------	---------	------	------

Order No.	EAN No.	Type	Page
0205400000	4008190027223	EP 2 SAKG46/32 HP/TF/GE	I.4
0205700000	4008190073725	QB 2 SAKT1	I.21
0205800000	4008190173364	QB 3 SAKT1	I.21
0205900000	4008190046200	QB 4 SAKT1	I.21
0206160000	4008190080020	EWK 1	B.27
0206160000	4008190080020	EWK 1	H.10
0206820000	4008190048327	SAKS 2	B.24
0207400000	4008190061296	QL 2 SAK6N-SAK35	I.10
0207530000	4008190107925	DS 14 SAK4	I.12
0207630000	4008190087401	DS 12.5 SAK10	I.12
0207730000	4008190148843	DS 12.5 SAK6N	I.12
0207800000	4008190144364	QL 2 SAKS2	I.9
0207800000	4008190144364	QL 2 SAKS2	B.27
0207900000	4008190047795	QL 3 SAKS2	B.27
0207900000	4008190047795	QL 3 SAKS2	I.9
0208000000	4008190069100	QL 4 SAKS2	I.9
0208000000	4008190069100	QL 4 SAKS2	B.27
0208500000	4008190067120	E 16/10A RT TNDZ	B.26
0208500000	4008190067120	E 16/10A RT TNDZ	A.28
0208600000	4008190015121	E 16/16A GR TNDZ	A.28
0208600000	4008190015121	E 16/16A GR TNDZ	B.26
0208700000	4008190044886	E 16/20A BL TNDZ	B.26
0208700000	4008190044886	E 16/20A BL TNDZ	A.28
0208800000	4008190037314	E 16/25A GE TNDZ	B.26
0208800000	4008190037314	E 16/25A GE TNDZ	A.28
0208900000	4008190112578	P 16/10 RT SAKS2	B.27
0208900000	4008190112578	P 16/10 RT SAKS2	A.29
0209000000	4008190144937	P 16/16 GR SAKS2	B.27
0209000000	4008190144937	P 16/16 GR SAKS2	A.29
0209100000	4008190055493	P 16/20 BL SAKS2	B.27
0209100000	4008190055493	P 16/20 BL SAKS2	A.29
0209760000	4008190018627	DK 4/32 LD 1D ROT 24VDC	B.63
0209860000	4008190122249	DK 4/32 LD ROT 24VDC	A.51
0209960000	4008190152727	DK 4/32 LD 1D GR 24VDC	B.63

Order No.	EAN No.	Type	Page
0240000000			
0241260000	4008190026738	MK 2/12	F.2
0243520000	4008190072834	MK 3/12	F.2
0243820000	4008190035365	MK 5/2 O.DE	F.4
0244220000	4008190107222	MK 4/16	F.3
0244600000	4008190103828	STB 8.5/D4.5/2/M3 SAKT4	I.15
0244920000	4008190108953	AP SAKT4 KRG	I.6
0245400000	4008190129187	GZ 12,5A/FF	A.28
0245400000	4008190129187	GZ 12,5A/FF	B.26
0246320000	4008190034092	SAKT 4/DU O.STB	B.33
0248500000	4008190103828	VH 13.5/4.9/3.3 SAK4	I.10
0248500000	4008190103828	VH 13.5/4.9/3.3 SAK4	B.29
0248920000	4008190109738	SAKS 3 GZ/6.3X32	I.9
0249000000	4008190129507	VH 12/4.9/3.3 SAK6N	I.10
0249000000	4008190129507	VH 12/4.9/3.3 SAK6N	I.21
0249000000	4008190129507	VH 12/4.9/3.3 SAK6N	I.9
0249100000	4008190085476	KMVF L1 6.3 EP/SW	D.8
0249200000	4008190004019	KMVF RE 6.3 EP/SW	D.8
0249300000	4008190004798	KMVT L1 2.4 EP/SW	D.9
0249400000	4008190159016	KMVT RE 2.4 EP/SW	D.9
0249600000	4008190022785	ZS 2/3/4	I.14

Order No.	EAN No.	Type	Page
0250000000			
0254120000	4008190130138	SAKT 4/LT O.STB	B.32
0254220000	4008190120351	SAKT 4/LT 1STB2.0	B.32
0258260000	4008190037488	HP 7 TSK31.5	I.16
0258360000	4008190114510	HP 8 ADP 1	I.16
0258660000	4008190033477	EW 35/SCHA/M3	I.12
0258760000	4008190012182	EWK 2/SCHA/M3/L	I.12
0259800000	4008190049300	SSCH 10X3X1000 MS/BK	H.2

Order No.	EAN No.	Type	Page
0260000000			
0261100000	4008190070779	AD 4 WSD SAKG54 HP/DBR	I.17
0263100000	4008190020477	AD 4 WSD SAKG28 HP/DBR	I.17
0263200000	4008190152802	AD 4 WSD SAKG40 HP/DBR	I.17
0263300000	4008190175528	AD 4 WSD SAKG46 HP/DBR	I.17
0263900000	4008190144333	AD 3 WSD SAKG54 HP/DBR	I.17
0265800000	4008190141660	G 25/1.00A/M RT	A.28
0265800000	4008190141660	G 25/1.00A/M RT	B.26
0266320000	4008190163811	AST 1 6.3 KRG	B.44
0266360000	4008190143411	AST 1 6.3	B.36
0266400000	4008190176488	AP AST1+5 DB	I.6
0266420000	4008190043483	AP AST1+5 KRG	I.4
0266420000	4008190043483	AP AST1+5 KRG	I.6
0266460000	4008190045517	AP AST1+5	I.6
0266500000	4008190102814	ZB 35/M6X16	H.4
0266700000	4008190152031	VH 8/4.9/3.3 SAK2.5	I.9
0266700000	4008190152031	VH 8/4.9/3.3 SAK2.5	I.10
0267000000	4008190146986	VH 17/8/5 SAK35	I.10
0267000000	4008190146986	VH 17/8/5 SAK35	I.9
0267100000	4008190187897	BFSC M4X30	I.9
0267100000	4008190187897	BFSC M4X30	H.3
0267100000	4008190187897	BFSC M4X30	I.10
0267200000	4008190022862	STB 25 IH/GE	I.20
0267200000	4008190022862	STB 25 IH/GE	I.15
0268660000	4008190136284	SAKD 2.5/35	A.2
0268880000	4008190061951	SAKD 2.5/35 BL	A.2
0269120000	4008190185978	SAKT 1/LT	B.31
0269320000	4008190023980	SAKT 1/QT1	B.31

Order No.	EAN No.	Type	Page
0270000000			
0270100000	4008190105136	TS 35X15/2.3 2M/CU/BK	H.9
0270320000	4008190009922	RSF 1 KRG	B.28
0270420000	4008190099107	AP RSF1 KRG	I.6
0270460000	4008190110635	AP RSF3	I.6
0270760000	4008190011420	QS 2/12/4	I.13
0270760000	4008190011420	QS 2/12/4	I.21
0270860000	4008190062620	QS 2/10/4	I.13
0270860000	4008190062620	QS 2/10/4	I.13
0270960000	4008190077006	QS 2/8/4	I.21
0270960000	4008190077006	QS 2/8/4	I.21
0271020000	4008190120856	SAK 16 KRG	B.7
0271060000	4008190078324	SAK 16	B.4
0271080000	4008190097578	SAK 16 BL	B.4
0271120000	4008190062606	AP SAK16 KRG	I.4
0271120000	4008190062606	AP SAK16 KRG	I.6
0271160000	4008190120429	AP SAK16	I.4
0271160000	4008190120429	AP SAK16	I.6
0271180000	4008190169800	AP SAK16 BL	I.6
0271200000	4008190155889	STB 25 IH/GN	I.15
0271200000	4008190155889	STB 25 IH/GN	I.20
0271300000	4008190111342	STB 25 IH/VI	I.15
0271300000	4008190111342	STB 25 IH/VI	I.20
0271400000	4008190029692	STB 25 IH/GR	I.12
0271400000	4008190029692	STB 25 IH/GR	I.15
0271500000	4008190030162	STB 25 IH/SW	I.12
0271500000	4008190030162	STB 25 IH/SW	I.15
0271800000	4008190046934	EP 1/BW SAKG28/32 HP/DB	I.5
0271900000	4008190172497	EP 2/BW SAKG46/32 HP/DB	I.5
0273400000	4008190106027	AD 3 SAK35	F.2
0273820000	4008190142117	MK 3/2	I.17
0273920000	4008190104894	MK 3/3	F.2
0274020000	4008190020712	MK 3/4	F.2
0274120000	4008190010607	MK 3/5	F.2

Order No.	EAN No.	Type	Page
0274220000	4008190153847	MK 3/6	F.2
0274320000	4008190187507	MK 3/7	F.2
0274420000	4008190185015	MK 3/8	F.2
0274520000	4008190074722	MK 3/9	F.2
0274620000	4008190117559	MK 3/10	F.2
0279500000	4008190404130	AP SAK2.5 GE	I.6
0279520000	4008190014117	AP SAK2.5 KRG	I.6
0279520000	4008190014117	AP SAK2.5 KRG	I.4
0279530000	4008190025575	AP SAK2.5 KRS	I.4
0279540000	4008190000073	AP SAK2.5 OR	I.6
0279560000	4008190075736	AP SAK2.5	I.6
0279560000	4008190075736	AP SAK2.5	B.34
0279570000	4008190022525	AP SAK2.5 KRG BL	I.6
0279580000	4008190050702	AP SAK2.5 BL	I.6
0279620000	4008190100087	SAK 2.5 KRG	B.6
0279660000	4008190069926	SAK 2.5	B.2
0279670000	4008190186630	SAK 2.5 KRG/BL	B.6
0279680000	4008190076474	SAK 2.5 BL	B.2

Order No.	EAN No.	Type	Page
0280000000			
0280100000	4008190036348	DKSUE NSCH/ESCH	H.2
0280200000	4008190012953	NSCH 1M	H.2
0280300000	4008190143053	ESCH 1 M	H.2
0280600000	4008190023188	STB 8.5/5/2.3 M3 SAK2.5	I.15
0282000000	4008190078492	SK SAKS1/G25	B.27
0282100000	4008190004606	SK G20/SAKS1	B.27
0283100000	4008190087982	AD 4 WSD SAKG32 HP/DBR	I.17
0285100000	4008190189297	VH 19/5/5.3 SAK4-16	I.12
0285300000	4008190072902	AD 4 SAK4	I.17
0286400000	4008190085339	DSTV VH 6.5	I.10
0286620000	4008190116750	SAKG 32 I	B.54
0286720000	4008190081010	SAKG 32 III	B.55
0286820000	4008190163273	SAKG 40 I	B.56
0286920000	4008190137847	SAKG 40 III	B.57

Order No.	EAN No.	Type	Page
0290000000			
0292460000	4008190105440	SCHT 5	K.15
0292500000	4008190177027	BFSC M3X25	I.12
0292500000	4008190177027	BFSC M3X25	I.10
0292520000	4032248014026	TS 32X15 2M/CRN	H.8
0293800000	4008190042356	PS 2.0 OR	I.14
0293900000	4008190091767	GZ 10.0A	A.28
0293900000	4008190091767	GZ 10.0A	B.26
0294220000	4008190050580	SAKR LL 2STB/KRG	B.50
0294260000	4008190029791	SAKR LL 2STB	B.43
0294360000	4008190054625	AKZ 4	E.3
0294380000	4008190002152	AKZ 4 BL	E.3
0294420000	4008190128289	AP AKZ4 KRG	I.4
0294420000	4008190128289	AP AKZ4 KRG	I.6
0294460000	4008190466268	AP AKZ4	I.4
0294460000	4008190466268	AP AKZ4	I.6
0294460000	4008190466268	AP AKZ4	E.3
0294480000	4008190021832	AP AKZ4 BL	I.6
0294480000	4008190021832	AP AKZ4 BL	E.3
0294500000	4008190047603	GZ 2.0A	B.26
0294500000	4008190047603	GZ 2.0A	A.28
0294600000	4008190141233	GZ 5.0A	A.28
0294600000	4008190141233	GZ 5.0A	B.26
0295700000	400819018351	GZ 3.0A	B.26
0295700000	400819018351	GZ 3.0A	A.28
0295800000	4008190017095	GZ 7.0A	A.28
0295800000	4008190017095	GZ 7.0A	B.26
0295900000	4008190133337	FKSC M3X25 D9/SW2.5	H.11
0296200000	4008190043391	BFSC M3X30	I.10
0296700000	4008190081764	BFSC M5X8	H.2
0296800000	4008190008000	VH 5/4/2.8 AKZ4	I.9
0297060000	4008190117052	DK 4SS/35 FF 8X2.8	A.39
0297200000	4008190091776	QL 2 DLJ	I.9
0297300000	4008190034634	QL 3 DLJ	I.9
0297520000	4008190128401	SAKS 3 G/5X30 500V	B.23
0297600000	4008190173395	AD 3 SAK4	I.17
0297700000	4008190086787	AD 3 SAK6N	I.17
0297800000	4008190080884	AD 3 SAK16	I.17
0297900000	4008190038229	AD 3 SAK2.5	I.17
0298020000	4008190156831	AST 3 6.3 KRG	B.44
0298120000	4008190172213	AP AST3+4 KRG	I.4
0298120000	4008190172213	AP AST3+4 KRG	

Order No.	EAN No.	Type	Page	Order No.	EAN No.	Type	Page	Order No.	EAN No.	Type	Page
0303580000	4008190016944	SAK 35 BL	B.4	0336400000	4008190037680	Q 2 AKZ4	E.3	0358500000	4008190049195	STB 7/D4/2.3/M3 ZB/SAKC	I.15
0303620000	400819005184	AP SAK35 KRG	I.6	0336500000	4008190121730	Q 3 AKZ4	I.9	0359000000	4008190061548	KISC M3X15/6 SAK2.5	I.10
0303620000	4008190050184	AP SAK35 KRG	I.4	0336500000	4008190121730	Q 3 AKZ4	E.3	0359000000	4008190061548	KISC M3X15/6 SAK2.5	I.9
0303660000	4008190110765	AP SAK35/TW SAK16	I.4	0336500000	4008190121730	Q 3 AKZ4	I.11	0359260000	4008190012991	AP DK4	I.6
0303660000	4008190110765	AP SAK35/TW SAK16	I.6	0336600000	4008190096656	Q 4 AKZ4	E.3	0359280000	4008190031213	AP DK4 BL	I.6
0303670000	4008190009113	AP SAK35 KRG/BL	I.6	0336600000	4008190096656	Q 4 AKZ4	I.11	0359420000	4008190036010	SAKS 5 380AC	B.25
0303680000	4008190025199	AP SAK35/TW SAK16 BL	I.6	0336700000	4008190033842	Q 2 SAK4	I.9				
0303860000	4008190035723	ADK 1/1.5	E.11	0336800000	4008190089795	Q 3 SAK4	I.9				
0303880000	4008190168315	ADK 1/1.5 BL	E.11	0336900000	4008190036201	Q 4 SAK4	I.9				
0304000000	4008190150792	VH 13/5/3.5 SAK 10	I.10	0337660000	4008190062231	SAK 10/EN	C.3				
0306120000	4008190038311	SAKS 1/32 G20 GL 230VAC	B.27	0338100000	4008190189426	QL 10 SAK2.5	I.10	0361300000	4008190113131	E 18/20A BL	B.26
0306120000	4008190038311	SAKS 1/32 G20 GL 230VAC	B.22	0338100000	4008190189426	QL 10 SAK2.5	I.9	0361300000	4008190113131	E 18/20A BL	A.28
0307300000	4008190036140	QVS 2 SAKT1+2	I.20	0338200000	4008190107413	QL 10 SAK4	I.10	0361400000	4008190080785	E 18/25A GE	A.28
0307400000	4008190091941	QVS 4 SAKT1+2	I.20	0338200000	4008190107413	QL 10 SAK4	I.9	0361400000	4008190080785	E 18/25A GE	B.26
0309120000	4008190131791	SAK 2.5+LS KRG	B.49	0338300000	4008190176679	QL 10 SAK6N	I.10	0361500000	4008190131005	E 18/35A SW	A.28
0309220000	4008190049997	AP SAK2.5L KRG	I.6	0338300000	4008190176679	QL 10 SAK6N	I.21	0361500000	4008190131005	E 18/35A SW	B.26
0309220000	4008190049997	AP SAK2.5L KRG	I.4	0338300000	4008190176679	QL 10 SAK6N	I.9	0361600000	4008190144173	E 18/50A WS	B.26
0309270000	4008190124878	AP SAK2.5L KRG BL	I.6	0338600000	4008190106133	QL 10 SAK35	I.9	0361600000	4008190144173	E 18/50A WS	A.28
0309320000	4008190086848	SAKS 1/32 G25 GL 230VAC	B.27	0338600000	4008190106133	QL 10 SAK35	I.11	0361700000	4008190083861	E 18/63A KU	B.26
0309320000	4008190086848	SAKS 1/32 G25 GL 230VAC	B.23	0338600000	4008190106133	QL 10 SAK35	B.27	0361700000	4008190083861	E 18/63A KU	A.28
0309400000	4008190143176	VH 27/5/3.5 SAK10-35	I.10	0338800000	4008190127039	QL 10 SAKS1	I.9	0361800000	4008190106249	P 18/20 D02 BL SAKS5	B.27
0309700000	4008190037024	VH 16/5/3.5 SAK10-35	I.10	0338800000	4008190127039	QL 10 SAKS1	B.27	0361800000	4008190106249	P 18/20 D02 BL SAKS5	A.29
0309800000	4008190058838	BFSC M3X35	I.10	0338900000	4008190105723	QL 10 SAKS2	I.9	0361900000	4008190091101	P 18/25 D02 GE SAKS5	B.27
				0339000000	4008190025335	QL 10 SAKS4	I.9	0361900000	4008190091101	P 18/25 D02 GE SAKS5	A.29
				0339760000	4008190069544	SAK 16/EN	C.3	0362000000	4008190070175	P 18/35 D02 SW SAKS5	B.27
				0339860000	4008190076573	SAK 35/EN	C.4	0362000000	4008190070175	P 18/35 D02 SW SAKS5	A.29

0310000000

0310000000	4008190000059	PS 2.0 MC	I.14
0310320000	4008190181796	SAKT 4/TL STB2.0	B.32
0316500000	4008190061999	ZB 4	H.4
0316600000	4008190145989	ZB 16 ZKSC	H.4
0317000000	4008190158231	H25/30 BRAUN	J.9
0317100000	4008190049751	H25/36 BRAUN	J.9
0317200000	4008190023904	H35/30 BEIGE	J.9
0317300000	4008190051294	H35/39 BEIGE	J.9
0318000000	4008190059460	VH 19/6/4.2 SAKT1	I.21
0318560000	4008190062033	TW AKZ2.5	E.2
0318580000	4008190143657	TW AKZ2.5 BL	E.2

0320000000

0321220000	4008190167646	AST 4 SF 6.3 KRG	B.45
0321320000	4008190005313	SAKS 4	B.24
0322110000	4008190189310	ZB 4G SW	H.5
0322160000	4008190014278	ZB 4G EX E GN/GE	H.5
0322180000	4008190050504	ZB 4G BL	H.5
0323100000	4008190013585	EK 2	B.14
0323620000	4008190140489	SAK 2.5 LL KRG	B.50
0323660000	4008190114855	SAK 2.5 LL	B.41
0323670000	4008190039134	SAK 2.5 LL KRG/BL	B.50
0324020000	4008190055523	SAKC 10 STB/RE	B.19
0324120000	4008190049959	SAKC 10 2STB	B.19
0324460000	4008190132545	AKZ 4 S WA 2X2.8	E.9
0324560000	4008190125301	AKZ 4 SS SE 6.3/2.8	E.8
0326660000	4008190031510	AH 28 SAKG28	I.17
0326760000	4008190064976	AH 32 SAKG32	I.17
0326860000	4008190061258	AH 40 SAKG40	I.17
0326960000	4008190174712	AH 46 SAKG46	I.17
0328000000	4008190071165	QL 2 SAKS4	I.9
0328100000	4008190097639	QL 3 SAKS4	I.9
0328200000	4008190086428	QL 4 SAKS4	I.9
0328300000	4008190002190	E 14/6A GN	A.28
0328300000	4008190002190	E 14/6A GN	B.26
0328400000	4008190000288	E 14/10A RT	A.28
0328400000	4008190000288	E 14/10A RT	B.26
0328500000	4008190152161	E 14/16A GR	A.28
0328500000	4008190152161	E 14/16A GR	B.26
0328600000	4008190004248	P 14/6 D01 GN SAKS4	A.29
0328600000	4008190004248	P 14/6 D01 GN SAKS4	B.27
0328700000	4008190010294	P 14/10 D01 RT SAKS4	B.27
0328700000	4008190010294	P 14/10 D01 RT SAKS4	A.29
0328920000	4008190113339	SAKS 3/35 G/5X30 500V	A.25
0329120000	4008190012793	AP SAKT2 KRG	I.6
0329120000	4008190012793	AP SAKT2 KRG	I.4
0329300000	4008190084714	QVS 3 SAKT1+2	I.20
0329660000	4008190019792	AP AKZ1.5W	I.6
0329660000	4008190019792	AP AKZ1.5W	I.4

0330000000

0330620000	4008190048433	SAKT 2/TL STB	B.32
0330800000	4008190100650	TS 35X7.5 2M/AL/BK	H.9
0330930000	4008190149758	DS 9 SAK2.5	I.12
0334520000	4008190043247	AST 5 SF 6.3 KRG	B.45
0334560000	4008190051587	AST 5 SF 6.3	B.37
0334700000	4008190118839	BS 25 OJH SAKT1	I.21
0334820000	4008190011666	AKZ 4L SL VS KRG	E.12
0334860000	4008190019501	AKZ 4L SL VS	E.10
0334880000	4008190158156	AKZ 4L SL VS BL	E.10
0334900000	4008190057602	MB M6/M4 GR	H.11
0335200000	4008190114039	BS 25 IH/SW SAKT1	I.21
0335300000	4008190136864	BS 25 IH/GR SAKT1	I.21
0335400000	4008190086879	BS 25 IH/BL SAKT1	I.21
0335500000	4008190118877	BS 25 IH/RT SAKT1	I.21
0335600000	4008190113490	BS 25 IH/EN SAKT1	I.21
0335700000	4008190189235	BS 25 IH/GE SAKT1	I.21
0335800000	4008190039196	BS 25 IH/VI SAKT1	I.21
0336400000	4008190037680	Q 2 AKZ4	I.9
0336400000	4008190037680	Q 2 AKZ4	I.11

0336400000	4008190037680	Q 2 AKZ4	E.3
0336500000	4008190121730	Q 3 AKZ4	I.9
0336500000	4008190121730	Q 3 AKZ4	E.3
0336600000	4008190121730	Q 3 AKZ4	I.11
0336600000	4008190096656	Q 4 AKZ4	E.3
0336600000	4008190096656	Q 4 AKZ4	I.11
0336700000	4008190033842	Q 2 SAK4	I.9
0336800000	4008190089795	Q 3 SAK4	I.9
0336900000	4008190036201	Q 4 SAK4	I.9
0337660000	4008190062231	SAK 10/EN	C.3
0338100000	4008190189426	QL 10 SAK2.5	I.10
0338100000	4008190189426	QL 10 SAK2.5	I.9
0338200000	4008190107413	QL 10 SAK4	I.10
0338200000	4008190107413	QL 10 SAK4	I.9
0338300000	4008190176679	QL 10 SAK6N	I.10
0338300000	4008190176679	QL 10 SAK6N	I.21
0338300000	4008190176679	QL 10 SAK6N	I.9
0338600000	4008190106133	QL 10 SAK35	I.9
0338600000	4008190106133	QL 10 SAK35	B.27
0338800000	4008190127039	QL 10 SAKS1	I.9
0338800000	4008190127039	QL 10 SAKS1	B.27
0338900000	4008190105723	QL 10 SAKS2	I.9
0338900000	4008190105723	QL 10 SAKS2	B.27
0339000000	4008190025335	QL 10 SAKS4	I.9
0339760000	4008190069544	SAK 16/EN	C.3
0339860000	4008190076573	SAK 35/EN	C.4

0340000000

0340160000	4008190156350	AKZ 1.5L VS	E.10
0340460000	4008190091567	AP AKZ1.5	E.2
0340480000	4008190075378	AKZ 1.5 BL	E.2
0340560000	4008190138745	AP AKZ1.5	I.6
0340560000	4008190138745	AP AKZ1.5	E.2
0340580000	4008190118907	AP AKZ1.5 BL	E.2
0340580000	4008190118907	AP AKZ1.5 BL	I.6
0340720000	4008190160809	SAKC 4 KRG	B.19
0340820000	4008190080754	SAK 70 KRG	B.9
0340870000	4008190053321	SAK 70 KRG/BL	I.9
0340920000	4008190154684	AP 70 SAK70 KRG	B.4
0340920000	4008190154684	AP 70 SAK70 KRG	I.6
0340960000	4008190098681	AP SAK70/35	I.4
0340960000	4008190098681	AP SAK70/35	I.6
0341000000	4008190015299	STB 30.5 IH/SW	I.15
0341000000	4008190015299	STB 30.5 IH/SW	I.15
0341100000	4008190083960	STB 30.5 IH/GR	I.15
0341100000	4008190083960	STB 30.5 IH/GR	I.20
0341200000	4008190044077	STB 30.5 IH/BL	I.15
0341200000	4008190044077	STB 30.5 IH/BL	I.20
0341300000	4008190157852	STB 30.5 IH/RT	I.15
0341300000	4008190157852	STB 30.5 IH/RT	I.15
0341400000	4008190008093	STB 30.5 IH/EN	I.20
0341400000	4008190008093	STB 30.5 IH/EN	I.20
0341500000	4008190130961	STB 30.5 IH/GE	I.15
0341500000	4008190130961	STB 30.5 IH/GE	I.15
0341600000	4008190026035	STB 30.5 IH/VI	I.15
0343300000	4008190034115	STB 25 IH/RT	I.20
0343300000	4008190034115	STB 25 IH/RT	I.15
0343400000	4008190107192	STB 25 IH/BL	I.20
0343400000	4008190107192	STB 25 IH/BL	I.15
0343800000	4008190168032	QB 10 SAKT1	I.21
0344300000	4008190166489	AD 3 SAK70	I.17
0344400000	40081900229203	BFSC M5X45 PA/NA	I.17
0345300000	4008190000813	QL 2 SAK70	I.9
0345500000	4008190100698	VH 30.5/11/5.5 SAK70	I.9
0345600000	4008190058739	BFSC M5X45	I.9
0346200			

Order No.	EAN No.	Type	Page
0388700000	4008190082383	STB 35 IH/BL	I.15
0388700000	4008190082383	STB 35 IH/BL	I.20
0388800000	4008190177485	STB 35 IH/RT	I.15
0388800000	4008190177485	STB 35 IH/RT	I.20
0388900000	4008190010409	STB 35 IH/KN	I.15
0388900000	4008190010409	STB 35 IH/KN	I.20
0389000000	4008190396985	STB 35 IH/GE	I.15
0389000000	4008190396985	STB 35 IH/GE	I.20
0389100000	4008190137755	STB 35 IH/VI	I.20
0389100000	4008190137755	STB 35 IH/VI	I.15

0390000000

0395460000	4008190070311	DK 4/35 LD GR 24VDC	A.50
0395560000	4008190168872	DK 4/35 LD ROT 60VDC	A.50
0395760000	4008190029470	DK 4/35 LD GR 24VDC	A.50
0395860000	4008190100636	DK 4/35 LD ROT 60VDC	A.50
0395960000	4008190134372	DK 4/35 LD 1D ROT 24VAC	A.51
0396060000	4008190163693	DK 4/35 LD 1D 48VAC	A.51
0396260000	4008190176266	DK 4/35 GL 100K 115VAC	A.52
0396360000	4008190092023	DK 4/35 1D GET.SCH.	A.53
0396660000	4008190126551	DK 4/35 2D GET.SCH. A1	A.54
0396760000	4008190095482	DK 4/35 2D GET.SCH. A1	A.55
0396860000	4008190027100	DK 4/35 2D GET.SCH. A2	A.55
0396960000	4008190040888	DK 4/35 1D 1K5 GET.SCH	A.55

0400000000

0400100000	4008190068196	KISC M2.5X11/4.5 AKZ1.5	I.9
0401220000	4008190035655	SAK 4 S 6.3/2.8/KRG	B.45
0401260000	4008190134730	SAK 4 S 6.3/2.8	B.37
0401360000	4008190120986	AP DUSA4/35	I.6
0401460000	4008190188092	SO SH1	H.3
0407360001	4008190049980	DEK 6,5 FSZ 1-10	K.20
0407360011	4008190141172	DEK 6,5 FSZ 11-20	K.20
0407360021	4008190003494	DEK 6,5 FSZ 21-30	K.20
0407360031	4008190139346	DEK 6,5 FSZ 31-40	K.20
0407360041	4008190011055	DEK 6,5 FSZ 41-50	K.20
0407360051	4008190000639	DEK 6,5 FSZ 51-60	K.20
0407360061	4008190108571	DEK 6,5 FSZ 61-70	K.20
0407360071	4008190177829	DEK 6,5 FSZ 71-80	K.20
0407360081	4008190140694	DEK 6,5 FSZ 81-90	K.20
0407360091	4008190029258	DEK 6,5 FSZ 91-100	K.20
0407600000	4008190038328	QL 3 SAKZ628	I.9
0407700000	4008190078409	QL 4 SAKZ628	I.9
0407900000	4008190166465	SK.SCHLÜSSEL SW 6 D6911	J.24
0408730000	4008190101763	AP SAKH 4EX	I.6
0409500000	4008190090456	H0,5/12 ORANGE	J.9
0409600000	4008190079826	H0,75/12 WEISS	J.9
0409700000	4008190152222	H1/12 GELB	J.9

0410000000

0412120000	4008190074180	SAKR KRG	B.18
0412160000	40081900116418	SAKR	B.16
0412180000	4008190026745	SAKR BL	B.16
0412220000	4008190049058	SAKR 2STB KRG	B.18
0412260000	4008190054403	SAKR 2STB	B.16
0412280000	4008190096915	SAKR 2STB BL	B.16
0412460000	4008190067762	SAKR LS	B.42
0412760000	4008190035310	SAKR 15	E.3
0412860000	4008190018290	SAKR 15 2STB	E.3
0413160000	4008190077921	SAKR D 2STB2.3	B.17

0430000000

0430300000	4008190077174	G 2/0.10A/F	B.26
0430300000	4008190077174	G 2/0.10A/F	A.28
0430400000	4008190152383	G 2/0.20A/F	B.26
0430400000	4008190152383	G 2/0.20A/F	A.28
0430500000	4008190153991	G 2/0.25A/F	B.26
0430500000	4008190153991	G 2/0.25A/F	A.28
0430600000	4008190046835	G 2/0.50A/F	B.26
0430600000	4008190046835	G 2/0.50A/F	A.28
0430700000	4008190093877	G 2/0.1.00A/F	B.26
0430700000	4008190093877	G 2/0.1.00A/F	A.28
0430800000	4008190031503	G 2/0.1.60A/F	A.28
0430800000	4008190031503	G 2/0.1.60A/F	B.26
0430900000	4008190123567	G 2/0.2.00A/F	B.26
0430900000	4008190123567	G 2/0.2.00A/F	A.28
0431000000	4008190085513	G 2/0.2.50A/F	B.26
0431000000	4008190085513	G 2/0.2.50A/F	A.28
0431100000	4008190012977	G 2/0.3.15A/F	B.26
0431100000	4008190012977	G 2/0.3.15A/F	A.28
0431200000	4008190022983	G 2/0.4.00A/F	B.26
0431200000	4008190022983	G 2/0.4.00A/F	A.28
0431300000	4008190185381	G 2/0.5.00A/F	A.28
0431300000	4008190185381	G 2/0.5.00A/F	B.26
0431400000	4008190086053	G 2/0.6.30A/F	A.28
0431400000	4008190086053	G 2/0.6.30A/F	B.26
0437720000	4008190040291	SAKT 2/LT 4STB	B.32
0437920000	4008190163549	SAKT 1/LT STB1/4	B.31
0438000000	4008190080938	SSCH 10X3X1000 ST/ZN	H.2
0438560000	4008190133351	AP DK4/380 Q	I.6
0438560000	4008190133351	AP DK4/380 Q	I.4
0439000000	4008190131210	G 2/0.63A/F	A.28
0439000000	4008190131210	G 2/0.63A/F	B.26
0439120000	4008190005146	AST 4 S 6.3/2.8 KRG	B.45

Order No.	EAN No.	Type	Page
0442420000	4008190002923	AST 3 6.3/2.8 KRG	B.44
0442470000	4008190002923	AST 3 6.3/2.8 KRG/BL	B.44
0443620000	4008190095642	SAK 4/35 KRG	A.7
0443660000	4008190019990	SAK 4/35	A.3
0443670000	4008190126186	SAK 4/35 KRG/BL	A.7
0443680000	4008190003869	SAK 4/35 BL	A.3
0443720000	4008190183899	SAK 10/35 KRG	A.8
0443760000	4008190136949	SAK 10/35	A.3
0443770000	4008190103781	SAK 10/35 KRG/BL	A.8
0443780000	4008190152512	SAK 10/35 BL	A.3
0444200000	4008190110284	H50/36 OLIV	J.9
0445420000	4008190085438	SAKT 2/LT O.STB	B.32
0445860000	4008190021733	AKZ 4 SW 1X1	E.14
0447240000	4008190457044	AP ST5 PPO/SW	I.6
0447260000	4032248183913	AP ST5 PA/VE	I.6

0440000000

0451300000	4008190128265	POSC M3X20 PA/NA	I.17
0456700000	4008190150044	Q 2 SAK6N	I.21
0456700000	4008190150044	Q 2 SAK6N	I.9
0456800000	4008190110277	Q 3 SAK6N	I.21
0456800000	4008190110277	Q 3 SAK6N	I.9
0456900000	4008190032579	Q 4 SAK6N	I.21
0456900000	4008190032579	Q 4 SAK6N	I.9
0457000000	4008190153762	Q 10 SAK6N	I.21
0457000000	4008190153762	Q 10 SAK6N	I.9
0457100000	4008190103545	Q 2 SAK10	I.9
0457200000	4008190135379	Q 3 SAK10	I.9
0457300000	4008190129750	Q 4 SAK10	I.9
0457400000	4008190016166	Q 10 SAK10	I.9
0457500000	4008190055349	Q 2 SAK16	I.9
0457600000	4008190022280	Q 3 SAK16	I.9
0457700000	4008190070823	Q 4 SAK16	I.9
0457800000	4008190082512	Q 10 SAK16	I.9
0459500000	4008190032692	ZBE 6	H.4

0450000000

0460020000	4008190130206	AP SAK4 KRG M.FU	I.6
0460360000	4008190001094	AST 3/35 6.3/2.8	A.36
0460460000	4008190061319	AST 4/35 SF 6.3/2.8	A.37
0460490000	4008190039486	AP SAK2.5/35 DB	I.6
0460560000	4008190048334	AP SAK2.5/35 + AST3+4	I.6
0460580000	4008190081164	AP SAK2.5/35 BL	I.6
0460660001	4008190186685	DEK 5 FSZ 1-10	K.20
0460660011	4008190087647	DEK 5 FSZ 11-20	K.20
0460660021	4008190105358	DEK 5 FSZ 21-30	K.20
0460660031	4008190049782	DEK 5 FSZ 31-40	K.20
0460660041	4008190112660	DEK 5 FSZ 41-50	K.20
0460660051	4008190138226	DEK 5 FSZ 51-60	K.20
0460660061	4008190054601	DEK 5 FSZ 61-70	K.20
0460660071	4008190089634	DEK 5 FSZ 71-80	K.20
0460660081	4008190050962	DEK 5 FSZ 81-90	K.20
0460660091	4008190130794	DEK 5 FSZ 91-100	K.20
0461100000	4008190034818	QB 2 WI RA8 IS	I.13
0461200000	4008190161699	QB 3 WI RA8 IS	I.13
0461300000	4008190025373	QB 4 WI RA8 IS	I.13
0462900000	4008190033248	H0,75/14 WEISS	J.9
0463000000	4008190024697	H1/14 GELB	J.9
0463100000	4008190068509	H1,5/14 ROT	J.9
0464400000	4008190128326	SAKR LL	B.43
0467460000	4008190002749	SAK 4/EN	C.2
0467480000	4008190065669	SAK 4/EN BL	C.2
0467960000	4008190110321	DK 4/32 1D CSA A2	B.66
0467980000	4008190140861	DK 4/32 1D CSA A2	B.66
0468060000	4008190013158	DEK 6,5 NEUTRAL	K.9
0468060000	4008190013158	DEK 6,5 NEUTRAL	K.20
0468091686	4008190160579	DEK 6,5 RT NEUTRAL	K.20
0468091687	4008190087890	DEK 6,5 GE NEUTRAL	K.20
0468091688	4008190168148	DEK 6,5 GN NEUTRAL	K.20
0468091689	4008190058203	DEK 6,5 VI NEUTRAL	K.20
0468091690	4008190115708	DEK 6,5 OR NEUTRAL	K.20
0468091693	4008190144746	DEK 6,5 BL NEUTRAL	K.20
0468091694	4008190005726	DEK 6,5 SW NEUTRAL	K.20
0468160001	4008190070816	DEK 6,5 FW 1-50	K.20
0468160051	4008190021542	DEK 6,5 FW 51-100	K.20
0468160101	4008190085346	DEK 6,5 FW 101-150	K.20
0468160151	4008190115029	DEK 6,5 FW 151-200	K.20
0468160201	4008190026752	DEK 6,5 FW 201-250	K.20
0468160251	4008190170493	DEK 6,5 FW 251-300	K.20
0468160301	4008190121761	DEK 6,5 FW 301-350	K.20
0468160351	4008190118921	DEK 6,5 FW 351-400	K.20
0468160401	4008190108045	DEK 6,5 FW 401-450	K.20
0468160451	4008190183219	DEK 6,5 FW 451-500	K.20
0468160501	4008190021269	DEK 6,5 FW 501-550	K.20
0468160551	4008190175849	DEK 6,5 FW 551-600	K.20
0468160601	4008190051938	DEK 6,5 FW 601-650	K.20
0468160651	4008190096526	DEK 6,5 FW 651-700	K.20
0468160701	4008190010775	DEK 6,5 FW 701-750	K.20
0468160751	4008190168766	DEK 6,5 FW 751-800	K.20
0468160801	4008190087128	DEK 6,5 FW 801-850	K.20
0468160851	4008190134044	DEK 6,5 FW 851-900	K.20
0468160901	4008190126148	DEK 6,5 FW 901-950	K.20
0468160951	4008190025649	DEK 6,5 FW 951-999	K.20
0468260001	4008190022211	DEK 6,5 FS 1-50	K.20

0460000000

0468260051	4008190162900	DEK 6,5 FS 51-100	K.20
0468260101	4008190049218	DEK 6,5 FS 101-150	K.20
0468260151	4008190078768	DEK 6,5 FS 151-200	K.20
0468260201	4008190004071	DEK 6,5 FS 201-250	K.20
0468260251	4008190112875	DEK 6,5 FS 251-300	K.20
0468260301	4008190076054	DEK 6,5 FS 301-350	K.20
0468260351	4008190073473	DEK 6,5 FS 351-400	K.20
0468260401	4008190075545	DEK 6,5 FS 401-450	K.20
0468260451	4008190186920	DEK 6,5 FS 451-500	K.20
0468260501	4008190037772	DEK 6,5 FS 501-550	K.20
0468260551	4008190002657	DEK 6,5 FS 551-600	K.20
0468260601	4008190082192</		

Order No.	EAN No.	Type	Page	Order No.	EAN No.	Type	Page	Order No.	EAN No.	Type	Page
0473391687	4008190131586	DEK 5 GE NEUTRAL	K.20	0494920000	4008190007584	SH 2	L.12	0522660006	4008190160890	DEK 5 GW 6	K.20
0473391688	4008190057473	DEK 5 GN NEUTRAL	K.20	0495060000	4008190103217	SAK 2.5/35 SL	A.41	0522660007	4008190011949	DEK 5 GW 7	K.20
0473391689	4008190102494	DEK 5 VI NEUTRAL	K.20	0495160000	4008190160777	EWK 1 ALT	H.10	0522660008	4008190171513	DEK 5 GW 8	K.20
0473391690	4008190159375	DEK 5 OR NEUTRAL	K.20	0495360000	4008190022648	DK 4/32 LD ROT 24VDC A1	B.62	0522660009	4008190105129	DEK 5 GW 9	K.20
0473391691	4008190165079	DEK 5 GR NEUTRAL	K.20	0495660000	4008190048518	MOFUJ 35	H.11	0522660010	4008190162788	DEK 5 GW 10	K.20
0473391692	4008190100056	DEK 5 BR NEUTRAL	K.20	0497520000	4008190521462	RSF 2	B.29	0522660011	4008190022051	DEK 5 GW 11	K.20
0473391693	4008190187415	DEK 5 BL NEUTRAL	K.20	0497560000	4008190158590	RSF 3 PA	B.28	0522660012	4008190034764	DEK 5 GW 12	K.20
0473391694	4008190085407	DEK 5 SW NEUTRAL	K.20	0498000000	4008190042493	TS 35X15/2.3 2M/ST/ZN	H.9	0522660013	4008190047245	DEK 5 GW 13	K.20
0473460001	4008190135157	DEK 5 FW 1-50	K.20	0498000000	4008190042493	TS 35X15/2.3 2M/ST/ZN	B.27	0522660014	4008190177706	DEK 5 GW 14	K.20
0473460005	4008190085667	DEK 5 FW 51-100	K.20	0499280000	4008190086077	NT 16/35 10X3 BL	A.31	0522660015	4008190081997	DEK 5 GW 15	K.20
0473460101	4008190033323	DEK 5 FW 101-150	K.20	0500000000							
0473460151	4008190062958	DEK 5 FW 151-200	K.20	0501470000	4008190041052	NT 6/35 10X3 KRG/BL	A.30	0522660016	4008190175252	DEK 5 GW 16	K.20
0473460201	4008190014520	DEK 5 FW 201-250	K.20	0501520000	4008190047801	SAKS 1/35/G25	A.25	0522660017	4008190181888	DEK 5 GW 17	K.20
0473460251	4008190123529	DEK 5 FW 251-300	K.20	0501620000	4008190111229	SAKS 1/35/G20	A.24	0522660018	4008190181888	DEK 5 GW 18	K.20
0473460301	4008190113094	DEK 5 FW 301-350	K.20	0501820000	4008190090166	SAKS 4/35	A.26	0522660019	4008190131357	DEK 5 GW 19	K.20
0473460351	4008190110444	DEK 5 FW 351-400	K.20	0502120000	4008190142360	SAKS 5/35	A.27	0522660020	4008190164492	DEK 5 GW 20	K.20
0473460401	4008190138899	DEK 5 FW 401-450	K.20	0502260000	4008190052294	ZB 35K GE/GN M6X16	H.5	0522660021	4008190039660	DEK 5 GW 21	K.20
0473460451	4008190024413	DEK 5 FW 451-500	K.20	0502610000	400819032587	ZB 35K SW M6X16	H.5	0522660022	4008190104005	DEK 5 GW 22	K.20
0473460501	4008190091668	DEK 5 FW 501-550	K.20	0502660000	4008190052294	ZB 35K GE/GN M6X16	H.5	0522660023	40081901907305	DEK 5 GW 23	K.20
0473460551	4008190056100	DEK 5 FW 551-600	K.20	0502760000	4008190157678	IK 35/ZB35 GG	H.4	0522660024	4008190052478	DEK 5 GW 24	K.20
0473460601	4008190161750	DEK 5 FW 601-650	K.20	0502780000	4008190141455	IK 35/ZB35 BL	H.4	0522660025	4008190082777	DEK 5 GW 25	K.20
0473460651	4008190050542	DEK 5 FW 651-700	K.20	0502810000	4008190332563	ZB 16K SW	H.5	0522660026	4008190081805	DEK 5 GW 26	K.20
0473460701	40081900004743	DEK 5 FW 701-750	K.20	0502860000	4008190188795	ZB 16K GE/GN	H.5	0522660027	4008190119904	DEK 5 GW 27	K.20
0473460751	4008190128012	DEK 5 FW 751-800	K.20	0502880000	4008190014186	ZB 16K BL	H.5	0522660028	4008190120719	DEK 5 GW 28	K.20
0473460801	4008190120610	DEK 5 FW 801-850	K.20	0502960000	4008190113438	IK 16/ZB16 GG	H.4	0522660029	4008190120924	DEK 5 GW 29	K.20
0473460851	4008190131784	DEK 5 FW 851-900	K.20	0502980000	4008190159696	IK 16/ZB16 BL	H.4	0522660030	4008190094232	DEK 5 GW 30	K.20
0473460901	4008190162511	DEK 5 FW 901-950	K.20	0503500000	4008190182083	MB M3/M5 CRM	H.11	0522660031	4008190020347	DEK 5 GW 31	K.20
0473460951	4008190062408	DEK 5 FW 951-999	K.20	0509560000	4008190120580	DK 4/32 GL 330K 230VAC	B.64	0522660032	4008190064839	DEK 5 GW 32	K.20
0473560001	4008190133412	DEK 5 FS 1-50	K.20	0510000000							
0473560051	4008190083809	DEK 5 FS 51-100	K.20	0510300000	4008190018368	G 25/0.50A/M WS	B.26	0522660033	4008190073183	DEK 5 GW 33	K.20
0473560101	4008190009632	DEK 5 FS 101-150	K.20	0510300000	4008190018368	G 25/0.50A/M WS	A.28	0522660034	4008190014992	DEK 5 GW 34	K.20
0473560151	4008190038922	DEK 5 FS 151-200	K.20	0510420000	4008190172428	TS 15X5 2M/ST/ZN	H.8	0522660035	4008190016494	DEK 5 GW 35	K.20
0473560201	4008190003272	DEK 5 FS 201-250	K.20	0514210000	4008190005047	TS 15X5 1M/ST/ZN	H.8	0522660036	4008190159139	DEK 5 GW 36	K.20
0473560251	4008190112073	DEK 5 FS 251-300	K.20	0514300000	4008190052263	TSK 35X15 2M PVC/GR	H.9	0522660037	4008190021146	DEK 5 GW 37	K.20
0473560301	4008190150938	DEK 5 FS 301-350	K.20	0514400000	4008190086152	TS 32X15/LL 2M/ST/ZN	H.8	0522660038	4008190012885	DEK 5 GW 38	K.20
0473560351	4008190148041	DEK 5 FS 351-400	K.20	0514410000	4008190175283	TS 32X15/LL 1M/ST/ZN	H.8	0522660039	4008190001285	DEK 5 GW 39	K.20
0473560401	4008190188504	DEK 5 FS 401-450	K.20	0514500000	4008190046019	TS 35X7.5/LL 2M/ST/ZN	H.9	0522660040	4008190175771	DEK 5 GW 40	K.20
0473560451	4008190074982	DEK 5 FS 451-500	K.20	0514510000	4008190116620	TS 35X7.5/LL 1M/ST/ZN	H.9	0522660041	4008190082789	DEK 5 GW 41	K.20
0473560501	4008190155605	DEK 5 FS 501-550	K.20	0514580000	4032248318957	TS 35X7.5/LL 2M/ST/ZN /WS/BL	H.9	0522660042	4008190143725	DEK 5 GW 42	K.20
0473560551	4008190120498	DEK 5 FS 551-600	K.20	0517960000	4008190001742	SOHT 7	K.15	0522660043	4008190166793	DEK 5 GW 43	K.20
0473560601	4008190048143	DEK 5 FS 601-650	K.20	0518160000	4008190002633	SAKR LS 2STB	B.42	0522660044	4008190000219	DEK 5 GW 44	K.20
0473560651	4008190092559	DEK 5 FS 651-700	K.20	0518200000	4008190122416	AD 4 SAK16	L.17	0522660045	4008190142520	DEK 5 GW 45	K.20
0473560701	4008190059217	DEK 5 FS 701-750	K.20	0518960001	4008190014261	DEK 6 FWZ 1-10	K.20	0522660046	4008190056889	DEK 5 GW 46	K.20
0473560751	4008190027384	DEK 5 FS 751-800	K.20	0518960011	4008190104989	DEK 6 FWZ 11-20	K.20	0522660047	4008190161507	DEK 5 GW 47	K.20
0473560801	4008190032715	DEK 5 FS 801-850	K.20	0518960021	4008190158132	DEK 6 FWZ 21-30	K.20	0522660048	4008190037130	DEK 5 GW 48	K.20
0473560851	4008190044220	DEK 5 FS 851-900	K.20	0518960021	4008190158132	DEK 6 FWZ 21-30	K.20	0522660049	4008190189648	DEK 5 GW 49	K.20
0473560901	4008190088873	DEK 5 FS 901-950	K.20	0518960031	4008190103156	DEK 6 FWZ 31-40	K.20	0522660050	4008190150716	DEK 5 GW 50	K.20
0473560951	4008190178475	DEK 5 FS 951-999	K.20	0518960041	4008190165000	DEK 6 FWZ 41-50	K.20	0522660051	4008190072339	DEK 5 GW 51	K.20
0474360000	4008190146177	EK 2.5N	B.12	0518960051	4008190155476	DEK 6 FWZ 51-60	K.20	0522660052	4008190149116	DEK 5 GW 52	K.20
0474460000	4008190042158	DK 4/32 LD ROT 24VDC A2	B.62	0518960061	4008190071943	DEK 6 FWZ 61-70	K.20	0522660053	4008190033651	DEK 5 GW 53	K.20
0474560000	4008190020880	ASK 1/EN	C.5	0518960071	4008190142919	DEK 6 FWZ 71-80	K.20	0522660054	4008190037130	DEK 5 GW 54	K.20
0475360000	4008190188047	ZB 4K GE/GN	H.5	0518960081	4008190104412	DEK 6 FWZ 81-90	K.20	0522660055	4008190004521	DEK 5 GW 55	K.20
0475380000	4008190010942	ZB 4K BL	H.5	0518960091	4008190183097	DEK 6 FWZ 91-100	K.20	0522660056	4008190161262	DEK 5 GW 56	K.20
0475460000	4008190065348	IK 4 GG ZB4	H.4	0518960101	4008190133535	DEK 6 FWZ 101-110	K.20	0522660057	4008190055585	DEK 5 GW 57	K.20
0475480000	4008190145668	IK 4 BL ZB4	H.4	0518960111	4008190084912	DEK 6 FWZ 111-120	K.20	0522660058	4008190104351	DEK 5 GW 58	K.20
0476260000	4008190158194	AP ADK1	I.6	0518960121	4008190118723	DEK 6 FWZ 121-130	K.20	0522660059	4008190116538	DEK 5 GW 59	K.20
0476520000	4008190134471	SAK 35/1K KRG	B.8	0518960131	4008190078621	DEK 6 FWZ 131-140	K.20	0522660060	4008190051129	DEK 5 GW 60	K.20
0476560000	4008190097400	SAK 35/K	B.5	0518960141	4008190157517	DEK 6 FWZ 141-150	K.20	0522660061	4008190179465	DEK 5 GW 61	K.20
0478220000	4008190140625	AST 1 6.3/2.8 KRG	B.44	0518960151	4008190162672	DEK 6 FWZ 151-160	K.20	0522660062	4008190117665	DEK 5 GW 62	K.20
0478260000	4008190003043	AST 1 6.3/2.8	B.36	0518960161	4008190131432	DEK 6 FWZ 161-170	K.20	0522660063	4008190172602	DEK 5 GW 63	K.20
0478820000	4008190126339	SAK 2.5 TS SE 1.6/KRG	B.47	0518960171	4008190084912	DEK 6 FWZ 171-180	K.20	0522660064	4008190001711	DEK 5 GW 64	K.20
0479220000	4008190021795	AST 5 SF 6.3/2.8 KRG	B.45	0518960181	4008190159467	DEK 6 FWZ 181-190	K.20	0522660065	4008190174750	DEK 5 GW 65	K.20
0479260000	4008190084486	AST 5 SF 6.3/2.8	B.37	0518960191	4008190064105	DEK 6 FWZ 191-200	K.20	0522660066	4008190157555	DEK 5 GW 66	K.20
0479360000	4008190132941	SAK 4 S 6.3 KRG	A.36	0518960201	4008190024994	DEK 6 FWZ 201-210	K.20	0522660067	4008190067427	DEK 5 GW 67	K.20
0479460000	4008190108625	ADP 4/35 SF 6.3	A.37	0519060001	4008190152550	DEK 6,5 FWZ 1-10	K.22	0522660068	4008190131968	DEK 5 GW 68	K.20
0479520000	4008190104047	SAK 4 S 6.3 KRG	B.45	0519060011	4008190051747	DEK 6,5 FWZ 11-20	K.22	0522660069	4008190004682	DEK 5 GW 69	K.20
0479620000	4008190060992	SAK 4 SS 6.3/2.8 KRG	B.46	0519060021	4008190051747	DEK 6,5 FWZ 11-20	K.20	0522660070	4008190070199	DEK 5 GW 70	K.20
0479660000	4008190185527	SAK 4 SS 6.3/2.8	B.37	0519060031	4008190051747	DEK 6,5 FWZ 11-20	K.20	0522660071	4008190024284	DEK 5 GW 71	K.20
0479670000	4008190148782	SAK 4 SS 6.3/2.8 KRG/BL	B.46	0519060041	4008190132778	DEK 6,5 FWZ 21-30	K.22	0522660072	4008190167028	DEK 5 GW 72	K.20
0480000000											
0482700000	4008190166021	QB 2 WI RA6 IS	E.3	0519060051	4008190103026	DEK 6,5 FWZ 51-60	K.22	0522660073	4008190048426	DEK 5 GW 73	K.20
0482700000	4008190166021	QB 2 WI RA6 IS	L.13	0519060061	4008190019730	DEK 6,5 FWZ 61-70	K.22	0522660074	4008190083984	DEK 5 GW 74	K.20
0482800000	4008190145217										

Order No.	EAN No.	Type	Page	Order No.	EAN No.	Type	Page	Order No.	EAN No.	Type	Page
0522660106	4008190094799	DEK 5 GW 106	K.20	0522761026	4008190110079	DEK 5 GW F	K.20	0526960032	4008190070700	DEK 6 GW 32	K.20
0522660107	4008190063658	DEK 5 GW 107	K.20	0522761027	4008190160104	DEK 5 GW G	K.20	0526960033	4008190078751	DEK 6 GW 33	K.20
0522660108	4008190186661	DEK 5 GW 108	K.20	0522761028	4008190019471	DEK 5 GW H	K.20	0526960034	4008190086985	DEK 6 GW 34	K.20
0522660109	4008190083953	DEK 5 GW 109	K.20	0522761029	4008190187019	DEK 5 GW I	K.20	0526960035	4008190022198	DEK 6 GW 35	K.20
0522660110	4008190104825	DEK 5 GW 110	K.20	0522761030	4008190042127	DEK 5 GW J	K.20	0526960036	4008190111816	DEK 6 GW 36	K.20
0522660111	4008190118082	DEK 5 GW 111	K.20	0522761031	4008190136727	DEK 5 GW K	K.20	0526960037	4008190010249	DEK 6 GW 37	K.20
0522660112	4008190130022	DEK 5 GW 112	K.20	0522761032	4008190003845	DEK 5 GW L	K.20	0526960038	4008190026974	DEK 6 GW 38	K.20
0522660113	4008190070120	DEK 5 GW 113	K.20	0522761033	4008190025267	DEK 5 GW M	K.20	0526960039	4008190007362	DEK 6 GW 39	K.20
0522660114	4008190164263	DEK 5 GW 114	K.20	0522761034	4008190045746	DEK 5 GW N	K.20	0526960040	4008190181659	DEK 6 GW 40	K.20
0522660115	4008190067694	DEK 5 GW 115	K.20	0522761035	4008190184360	DEK 5 GW O	K.20	0526960041	4008190088897	DEK 6 GW 41	K.20
0522660116	4008190089498	DEK 5 GW 116	K.20	0522761036	4008190097509	DEK 5 GW P	K.20	0526960042	4008190149444	DEK 6 GW 42	K.20
0522660117	4008190074517	DEK 5 GW 117	K.20	0522761037	4008190008697	DEK 5 GW Q	K.20	0526960043	4008190018498	DEK 6 GW 43	K.20
0522660118	40081900023423	DEK 5 GW 118	K.20	0522761038	4008190038359	DEK 5 GW R	K.20	0526960044	4008190006235	DEK 6 GW 44	K.20
0522660119	4008190161620	DEK 5 GW 119	K.20	0522761039	4008190031947	DEK 5 GW S	K.20	0526960045	4008190148287	DEK 6 GW 45	K.20
0522660120	4008190122720	DEK 5 GW 120	K.20	0522761040	4008190052140	DEK 5 GW T	K.20	0526960046	4008190098704	DEK 6 GW 46	K.20
0522660121	4008190186135	DEK 5 GW 121	K.20	0522761041	4008190162382	DEK 5 GW U	K.20	0526960047	4008190166847	DEK 6 GW 47	K.20
0522660122	4008190178680	DEK 5 GW 122	K.20	0522761042	4008190045647	DEK 5 GW V	K.20	0526960048	4008190009809	DEK 6 GW 48	K.20
0522660123	4008190135669	DEK 5 GW 123	K.20	0522761043	4008190118983	DEK 5 GW W	K.20	0526960049	4008190005863	DEK 6 GW 49	K.20
0522660124	4008190054977	DEK 5 GW 124	K.20	0522761044	4008190119966	DEK 5 GW X	K.20	0526960050	4008190156367	DEK 6 GW 50	K.20
0522660125	4008190164140	DEK 5 GW 125	K.20	0522761045	4008190083977	DEK 5 GW Y	K.20	0526960051	4008190078027	DEK 6 GW 51	K.20
0522660126	4008190011475	DEK 5 GW 126	K.20	0522761046	4008190047337	DEK 5 GW Z	K.20	0526960052	4008190189525	DEK 6 GW 52	K.20
0522660127	4008190012335	DEK 5 GW 127	K.20	0522861047	4008190017057	DEK 5 GW A KLEIN	K.20	0526960053	4008190039769	DEK 6 GW 53	K.20
0522660128	4008190012519	DEK 5 GW 128	K.20	0522861048	4008190098452	DEK 5 GW B KLEIN	K.20	0526960054	4008190043193	DEK 6 GW 54	K.20
0522660129	4008190131333	DEK 5 GW 129	K.20	0522861049	4008190107895	DEK 5 GW C KLEIN	K.20	0526960055	4008190045920	DEK 6 GW 55	K.20
0522660130	4008190103033	DEK 5 GW 130	K.20	0522861050	4008190103804	DEK 5 GW D KLEIN	K.20	0526960056	4008190166601	DEK 6 GW 56	K.20
0522660131	4008190147815	DEK 5 GW 131	K.20	0522861051	4008190038663	DEK 5 GW E KLEIN	K.20	0526960057	4008190061593	DEK 6 GW 57	K.20
0522660132	4008190156077	DEK 5 GW 132	K.20	0522861052	4008190128494	DEK 5 GW F KLEIN	K.20	0526960058	4008190110420	DEK 6 GW 58	K.20
0522660133	4008190128111	DEK 5 GW 133	K.20	0522861053	4008190180768	DEK 5 GW G KLEIN	K.20	0526960059	4008190157760	DEK 6 GW 59	K.20
0522660134	4008190098940	DEK 5 GW 134	K.20	0522861054	4008190042936	DEK 5 GW H KLEIN	K.20	0526960060	4008190057145	DEK 6 GW 60	K.20
0522660135	4008190187705	DEK 5 GW 135	K.20	0522861055	4008190023430	DEK 5 GW I KLEIN	K.20	0526960061	4008190030926	DEK 6 GW 61	K.20
0522660136	4008190050771	DEK 5 GW 136	K.20	0522861056	4008190157746	DEK 5 GW J KLEIN	K.20	0526960062	4008190123628	DEK 6 GW 62	K.20
0522660137	4008190103873	DEK 5 GW 137	K.20	0522861057	4008190100971	DEK 5 GW K KLEIN	K.20	0526960063	4008190178314	DEK 6 GW 63	K.20
0522660138	4008190084066	DEK 5 GW 138	K.20	0522861058	4008190162061	DEK 5 GW L KLEIN	K.20	0526960064	4008190007812	DEK 6 GW 64	K.20
0522660139	4008190028053	DEK 5 GW 139	K.20	0522861059	4008190186739	DEK 5 GW M KLEIN	K.20	0526960065	4008190026363	DEK 6 GW 65	K.20
0522660140	4008190164966	DEK 5 GW 140	K.20	0522861060	4008190158774	DEK 5 GW N KLEIN	K.20	0526960066	4008190163006	DEK 6 GW 66	K.20
0522660141	4008190035082	DEK 5 GW 141	K.20	0522861061	4008190110260	DEK 5 GW O KLEIN	K.20	0526960067	4008190073411	DEK 6 GW 67	K.20
0522660142	4008190059361	DEK 5 GW 142	K.20	0522861062	4008190024727	DEK 5 GW P KLEIN	K.20	0526960068	4008190172794	DEK 6 GW 68	K.20
0522660143	4008190082796	DEK 5 GW 143	K.20	0522861063	4008190129316	DEK 5 GW Q KLEIN	K.20	0526960069	4008190010669	DEK 6 GW 69	K.20
0522660144	4008190033880	DEK 5 GW 144	K.20	0522861064	4008190161378	DEK 5 GW R KLEIN	K.20	0526960070	4008190075958	DEK 6 GW 70	K.20
0522660145	4008190139957	DEK 5 GW 145	K.20	0522861065	4008190157654	DEK 5 GW S KLEIN	K.20	0526960071	4008190065621	DEK 6 GW 71	K.20
0522660146	4008190053567	DEK 5 GW 146	K.20	0522861066	4008190153083	DEK 5 GW T KLEIN	K.20	0526960072	4008190173098	DEK 6 GW 72	K.20
0522660147	4008190086572	DEK 5 GW 147	K.20	0522861067	4008190075880	DEK 5 GW U KLEIN	K.20	0526960073	4008190054373	DEK 6 GW 73	K.20
0522660148	4008190082406	DEK 5 GW 148	K.20	0522861068	4008190153687	DEK 5 GW V KLEIN	K.20	0526960074	4008190125882	DEK 6 GW 74	K.20
0522660149	4008190042134	DEK 5 GW 149	K.20	0522861069	4008190039417	DEK 5 GW W KLEIN	K.20	0526960075	4008190124571	DEK 6 GW 75	K.20
0522660150	4008190155353	DEK 5 GW 150	K.20	0522861070	4008190141615	DEK 5 GW X KLEIN	K.20	0526960076	4008190086617	DEK 6 GW 76	K.20
0522660151	4008190040840	DEK 5 GW 151	K.20	0522861071	4008190108496	DEK 5 GW Y KLEIN	K.20	0526960077	4008190047719	DEK 6 GW 77	K.20
0522660152	4008190116897	DEK 5 GW 152	K.20	0522861072	4008190074265	DEK 5 GW Z KLEIN	K.20	0526960078	4008190128388	DEK 6 GW 78	K.20
0522660153	4008190120443	DEK 5 GW 153	K.20	0523060001	4008190021726	DEK 5 FWZ 1-10	K.20	0526960079	4008190171391	DEK 6 GW 79	K.20
0522660154	4008190087456	DEK 5 GW 154	K.20	0523060011	4008190112219	DEK 5 FWZ 11-20	K.20	0526960080	4008190057671	DEK 6 GW 80	K.20
0522660155	4008190017941	DEK 5 GW 155	K.20	0523060021	4008190129897	DEK 5 FWZ 21-30	K.20	0526960081	4008190027544	DEK 6 GW 81	K.20
0522660156	4008190138653	DEK 5 GW 156	K.20	0523060031	4008190074678	DEK 5 FWZ 31-40	K.20	0526960082	4008190151584	DEK 6 GW 82	K.20
0522660157	4008190186012	DEK 5 GW 157	K.20	0523060041	4008190172480	DEK 5 FWZ 41-50	K.20	0526960083	4008190083670	DEK 6 GW 83	K.20
0522660158	4008190008291	DEK 5 GW 158	K.20	0523060051	4008190162436	DEK 5 FWZ 51-60	K.20	0526960084	4008190134877	DEK 6 GW 84	K.20
0522660159	4008190019457	DEK 5 GW 159	K.20	0523060061	4008190079482	DEK 5 FWZ 61-70	K.20	0526960085	4008190149437	DEK 6 GW 85	K.20
0522660160	4008190071868	DEK 5 GW 160	K.20	0523060071	4008190114589	DEK 5 FWZ 71-80	K.20	0526960086	4008190162689	DEK 6 GW 86	K.20
0522660161	4008190163846	DEK 5 GW 161	K.20	0523060081	4008190075873	DEK 5 FWZ 81-90	K.20	0526960087	4008190104955	DEK 6 GW 87	K.20
0522660162	4008190064938	DEK 5 GW 162	K.20	0523060091	4008190000653	DEK 5 FWZ 91-100	K.20	0526960088	4008190010195	DEK 6 GW 88	K.20
0522660163	4008190084448	DEK 5 GW 163	K.20	0523760000	4008190030551	DK 4/32 2D CSA A2	B.67	0526960089	4008190105501	DEK 6 GW 89	K.20
0522660164	4008190067182	DEK 5 GW 164	K.20	0525500000	4008190141554	GZ 1.0A/F	A.28	0526960090	4008190121884	DEK 6 GW 90	K.20
0522660165	4008190049133	DEK 5 GW 165	K.20	0525500000	4008190141554	GZ 1.0A/F	B.26	0526960091	4008190107277	DEK 6 GW 91	K.20
0522660166	4008190150471	DEK 5 GW 166	K.20	0525910000	40081900977054	ZBE 6K SW	H.5	0526960092	4008190055950	DEK 6 GW 92	K.20
0522660167	4008190023959	DEK 5 GW 167	K.20	0525960000	4008190145026	ZBE 6K GE/GN	H.5	0526960093	4008190004262	DEK 6 GW 93	K.20
0522660168	4008190087548	DEK 5 GW 168	K.20	0525980000	4008190060886	ZBE 6K BL	H.5	0526960094	4008190007093	DEK 6 GW 94	K.20
0522660169	4008190078256	DEK 5 GW 169	K.20	0526060000	4008190128647	IK 6 GG ZBE6K	H.4	0526960095	4008190101732	DEK 6 GW 95	K.20
0522660170	4008190107048	DEK 5 GW 170	K.20	0526080000	4008190032425	IK 6 BL ZBE6K	H.4	0526960096	4008190131081	DEK 6 GW 96	K.20
0522660171	4008190059729	DEK 5 GW 171	K.20	0526400000	4008190009923	QB 75/6.2/9/WI	1.13	0526960097	4008190088781	DEK 6 GW 97	K.20
0522660172	4008190131371	DEK 5 GW 172	K.20	0526700000	4008190093723	ISPF QB75 SW	1.13	0526960098	4008190009847	DEK 6 GW 98	K.20
0522660173	4008190165895	DEK 5 GW 173	K.20	0526760000	4008190157821	ISPF QB75 RT	1.13	0526960099	4008190120900	DEK 6 GW 99	K.20
0522660174	4008190010423	DEK 5 GW 174	K.20	0526780000	4008190093105	ISPF QB75 BL	1.13	0526960100	4008190059194	DEK 6 GW 100	K.20
0522660175	4008190162849	DEK 5 GW 175	K.20	0526960001	4008190128234	DEK 6 GW 1	K.20	0526960200	4032248028627	DEK 6 GW 200	K.20
0522660176	4008190089269	DEK 5 GW 176	K.20	0526960002	4008190160708	DEK 6 GW 2	K.20	0527660000	4008190082130	DK 4/35	A.12
0522660177	4008190014308	DEK 5 GW 177	K.20	0526960003	4008190122119	DEK 6 GW 3	K.20	0527680000	4008190103682	DK 4/35 BL	A.12
0522660178	4008190057718	DEK 5 GW 178	K.20	0526960004	4008190045968	DEK 6 GW 4					

Order No.	EAN No.	Type	Page
0540000000			
0544120000	4008190162023	SAK 2.5 LS KRG	B.49
0544160000	4008190160715	SAK 2.5 LS	B.41
0544660000	4008190182724	DK 4/32 1D CSA GET.SCH.	B.65
0545060000	4008190025878	SAKR ST SE 2.4	B.41
0545300000	4008190125080	QB 58/8/9/WI	L.13
0545400000	4008190028794	QB 58/8/15	L.13
0546000000	4008190116705	ISPF QB58 SW	L.13
0546040000	4008190497941	ISPF QB58 RT	L.13
0546080000	4008190927035	ISPF QB58 BL	L.13
0546900000	4008190097370	G 25/0.25A/M GE	B.26
0546900000	4008190097370	G 25/0.25A/M GE	A.28

0550000000

0550200000	4008190141844	GL 110 AC/ZG203 SAKS6	B.27
0550300000	4008190038298	GL 220V AC/ZG233 SAKS6	B.27
0550420000	4008190140373	SAKT 1/DU2	B.31
0550520000	4008190077389	SAK 95 KRG	B.9
0550620000	4008190166874	SAK 35N KRG	B.9
0550660000	4008190165925	SAK 35N	B.5
0550920000	4008190160845	AP SAK95 KRG	L.6
0550920000	4008190160845	AP SAK95 KRG	L.4
0550970000	4008190087968	AP SAK95 KRG/BL	L.6
0551100000	4008190052669	VH 35/11/5.5 SAK95	L.9
0551200000	4008190038526	QL 2 SAKG28	L.9
0553400000	4008190122263	MB M5/M3 SW	H.11
0555760000	4008190143749	SAK 35N/K	B.5
0556660000	4008190123086	SH 3	H.3
0556700000	4008190188412	ZB 4/6	H.4
0556800000	4008190007751	ZB 16/6	H.4
0558360000	4008190075217	DEK 5 FWZ U,V,W,N,PE	K.20

0560000000

0564900000	4008190099282	QL 2 SAK35N	L.9
0565000000	4008190076597	QL 3 SAK35N	L.9
0565100000	4008190162139	QL 4 SAK35N	L.9
0565200000	4008190174286	QL 10 SAK35N	L.9
0565380000	4008190093440	IK 4/6 BL ZB4/6	H.4
0565460000	4008190032609	ZB 4/6K GE/GN	H.5
0565480000	4008190086831	ZB 4/6K BL	H.5
0565560000	4008190112448	IK 16/6 GG ZB16	H.4
0565580000	4008190161774	IK 16/6 BL ZB16/6	H.4
0565600000	4008190187071	H1,5/24 ROT	J.9
0565700000	4008190026837	H6/26 SCHWARZ	J.9
0565800000	4008190138646	H10/28 ELFENBEIN	J.9
0565900000	4008190022181	H16/24 GRÜN	J.9
0566000000	4008190165406	H16/28 GRÜN	J.9
0566700000	4008190000127	BEZ.-KARTE ADP	L.16
0567260000	4008190149161	SAK 2.5/35 LL	A.41
0567300000	4008190052423	PZ 3	J.8
0569560000	4008190164034	DK 4/32 GL 100K 115VAC	B.64
0569660000	4008190043681	ZB 16/6K GE/GN	H.5
0569680000	4008190024369	ZB 16/6K BL	H.5

0570000000

0571200000	4008190174200	SSCH 6X6X1000 MS/BK	H.2
0571300000	4008190015039	SSCH 6X6X1000 CU/SN	H.2
0572680000	4008190128395	SAKR SL 2STB BL	B.42
0573120000	4008190076139	SAKS 7/G20	B.27
0576120000	4008190021498	SAKS 7/G25	B.27
0576260000	4008190163297	DEK 5 GW	K.20
0576261198	4008190429072	DEK 5 GW +	K.20
0576261199	4008190429058	DEK 5 GW -	K.20
0576261202	4008190040352	DEK 5 GW ERDE	K.20
0576261203	4008190167097	DEK 5 GW ERDE I.KR.	K.20
0576261215	4008190010003	DEK 5 GW W-STROM	K.20
0576291737	4008190118228	DEK 5 GW RT/SW	K.20
0576291741	4008190081393	DEK 5 GW BL/SW -	K.20
0576700000	4008190119881	AD 4 SAK35N	L.17

0580000000

0582360002	4008190125363	DEK 5 FSZ 2,4,6...16	K.20
0582360018	4008190187422	DEK 5 FSZ 18,20,...32	K.20
0582460000	4008190090692	SAK 35/35/IK	A.5
0582560000		AP TOP2.5T-AST6T	L.4

0590000000

0590060000	4008190147228	DK 4Q/32	B.10
0590080000	4008190100407	DK 4Q/32 BL	B.10
0590160000	4008190103521	DK 4Q/35	A.12
0590180000	4008190088361	DK 4Q/35 BL	A.12
0590260000	4008190022419	DK 4QV/32	B.11
0590280000	4008190038762	DK 4QV/32 BL	B.11

0600000000

0607000000	4008190002732	TW SAKS2 HP/DBR/2	A.34
0607000000	4008190002732	TW SAKS2 HP/DBR/2	B.34
0608220000	4008190126278	SAK 35N/35 KRG	A.9
0608260000	4008190157470	SAK 35N/35	A.5

Order No.	EAN No.	Type	Page
0608320000	4008190184940	SAK 35N/35/IK KRG	A.9
0608360000	4008190090197	SAK 35N/35/IK	A.5
0608370000	4008190104436	SAK 35N/35/IK KRG/BL	A.9

0620000000

0620120000	4008190129330	MK 6/6	F.3
0620220000	40081900226905	MK 6/4	F.3
0620320000	4008190077440	MK 6/3	F.3
0620420000	4008190020569	MK 6/2	F.3
0623320000	40081900524692	RSF 2	B.29
0624720000	4008190158583	BK 2 CRN	F.5
0624920000	4008190157739	BK 3 CRN	F.5
0625120000	4008190013875	BK 4 CRN	F.5
0625220000	4008190026417	BK 6 CRN	F.5
0625320000	4008190156541	BK 12 CRN	F.5

0630000000

0630200000	4008190024246	KISC M5X50/26 SAK95	L.9
0630360000	4008190093716	SAK 4 S/35 6.3/2.8	A.37
0630460000	4008190098599	SAK 4 SS/35 6.3/2.8	A.38
0631160000	4008190086840	DK 4S SF 4X2.8	B.38
0631260000	400819007355	DK 4S SF 6.3/2.8	B.38
0631300000	4008190965013	AP DK4Q DB	L.6
0631360000	4008190101329	AP DK4S	L.6
0631380000	4008190109820	AP DK4S BL	L.6
0631860000	4008190167417	DEK 6 FWZ R,S,T,N,ERDE	K.20
0631961187	4008190154561	DEK 6 FWZ L1-PE	K.20
0631961203	4008190037208	DEK 6 FWZ L1-ERDE I.KRE	K.20
0632060000	4008190060329	DEK 6,5 FWZ R,S,T,N,ERD	K.20
0632060000	4008190060329	DEK 6,5 FWZ R,S,T,N,ERD	K.22
0632161187	4008190118365	DEK 6,5 FW L1-PE	K.22
0632161187	4008190118365	DEK 6,5 FW L1-PE	K.20
0632161203	4008190087227	DEK 6,5 FW L1-ERDE I.KR	K.22
0632161203	4008190087227	DEK 6,5 FW L1-ERDE I.KR	K.20
0632560000	4008190000684	DEK 6 FW L,N,PE	K.20
0632860000	4008190146719	DK 4/32 LD 1D 48VAC CSA	B.63
0634100000	4008190083199	AD 250	L.18
0634300000	4008190022426	HP EK132/2 AD250	L.18
0635060000	4008190012168	AP DKIT4	L.6
0635100000	4008190141745	H1,5/16 ROT	J.9
0635960000	4008190007140	KLBUE SH1	H.3
0636620000	4008190157876	SAKG 70/35 II/GW	A.44
0636800000	4008190152949	FM 5/TS35	H.11
0636900000	4008190174019	FM 6/TS35	H.11
0637120000	4008190111496	SAKG 32/35 I	A.42
0637220000	4008190083366	SAKG 32/35 III	A.44
0637320000	4008190018276	SAKG 32/35 II	A.43
0637420000	4008190070564	SAKG 32/35 II/GW	A.43
0637520000	4008190014872	SAKG 40/35 I	A.45
0637620000	4008190112189	SAKG 40/35 III	A.46
0637720000	4008190101367	SAKG 40/35 II	A.45
0637820000	4008190052409	SAKG 40/35 II/GW	A.45
0637920000	4008190122645	SAKG 46/35 II	A.46
0638020000	4008190008161	SAKG 46/35 II/GW	A.47
0638120000	4008190068646	SAKG 54/35 II	A.47
0638220000	4008190092443	SAKG 54/35 II/GW	A.47

0640000000

0641720000	4008190166304	SH 2 S	H.3
0642600000	4008190058258	FKSC M6X8 D9/SW3	H.11
0642760000	4008190043209	DK 4/32 2D CSA GET.SCH.	B.66
0646260000	4008190178574	MOFU 35/LO/1	H.11
0646400000	4008190060794	G 25/0.80A/M GR	A.28
0646400000	4008190060794	G 25/0.80A/M GR	B.26
0646560000	4008190144043	DK 4/32 LD GR 24VDC A2	B.62

0660000000

0661060000	4008190135287	EK 2.5/35	A.14
0661160000	4008190038823	EK 4/35	A.14
0661260000	4008190096588	EK 6/35	A.15
0661360000	4008190080594	EK 10/35	A.15
0661460000	4008190147600	EK 35/35	A.16
0662220000	4008190140991	SAK 95/35 KRG	A.10
0663160000	4008190022365	DK 4/35 GL 330K 230VAC	A.52
0663960000	4008190147853	DK 4/32 2D A1	B.67
0664860000	4008190103279	AST 1/35 6.3	A.36
0664960000	4008190043322	AST 5/35 SF 6.3/2.8	A.37
0667520000	4008190093976	SAKS 3/35 GZ/6.3X32	A.25

0680000000

0685260000	4008190175986	DK 4/32 1D 1K5	B.67
0686360000	4008190028992	DK 4/32 LD GR 24VDC CSA	B.62
0686560000	4008190137458	DK 4S/35 SF 4X2.8	A.40
0686660000	4008190100254	DK 4S/35 SF 6.3/2.8	A.39
0687020000	4008190113544	SAK 2.5 ST WA 2.4	B.48
0687360000	4008190059743	DKT 4	B.17
0687460000	4008190148690	DKT 4/35	A.19
0687560000	4008190009465	AP DKT4 PA	L.6
0687900000	4008190086459	FM 4/TS35	G.10
0687900000	4008190086459	FM 4/TS35	H.11
0688660000	4008190148461	DEK 6 FW 1-5 (10X)	K.20

0690000000

0690700000	4008190015770	H0,5/14 ORANGE	J.9
0692160000	4008190151805	DK 4/32 RC 220R/220NF	B.70
0697160000	4008190121716	AKZ 2.5	E.2
0697180000	4008190167448	AKZ 2.5 BL	E.2
0697260000	4008190128821	AP AKZ2.5K	L.6
0697360000	4008190098865	AP AKZ2.5	E.2
0697360000	4008190098865	AP AKZ2.5	L.6
0697380000	4008190018269	AP AKZ2.5 BL	E.2
0697380000	4008190018269	AP AKZ2.5 BL	L.6
0699660000	4008190041861	AST 1/35	

Order No.	EAN No.	Type	Page	Order No.	EAN No.	Type	Page	Order No.	EAN No.	Type	Page
1276960081	4008190155001	DEK 8 FWZ 81-90	K.20	1330000000				1610000000			
1276960081	4008190155001	DEK 8 FWZ 81-90	K.22	1333100000	4008190160364	H2,5/14S BLAU	J.12	1610000000	4008190263171	ZS 10/5 MC NEUTRAL	K.11
1276960091	4008190079062	DEK 8 FWZ 91-100	K.20	1333200000	4008190188016	AP TW/SS.../35	I.6	1610010000	4008190263423	ZS 10/5 MC BEDRUCKT	K.11
1276960091	4008190079062	DEK 8 FWZ 91-100	K.22	1338060000	4008190167141	DK 4Q/TC TYP J	B.34	1610020000	4008190444600	ZS 12/6 MC NEUTRAL	K.11
1276960101	4032248028085	DEK 8 FWZ 101-110	K.22	1338160000	4008190097769	DK 4Q/TC TYP T	B.34	1610030000	4008190456689	ZS 12/6 BEDRUCKT	K.11
1276960101	4032248028085	DEK 8 FWZ 101-110	K.20	1338260000	4008190109561	DK 4Q/TC TYP K	B.34	1610110000	4008190185305	TSTW D 4.3	H.11
1276960111	4008190135577	DEK 8 FWZ 111-120	K.20	1338300000	4008190030483	EK 70/35/M.2ZB OJK	A.17	1611930000	4008190002251	ZGB 30	K.17
1276960111	4008190135577	DEK 8 FWZ 111-120	K.22	1350000000				1615280000	4008190193850	AP MAK2.5	I.6
1276960121	4008190168339	DEK 8 FWZ 121-130	K.20	1358460000	4008190128883	DEK 5 FW 1,3,5,...99	K.20	1630000000			
1276960121	4008190168339	DEK 8 FWZ 121-130	K.22	1358560000	4008190075156	DEK 5 FW 2,4,...100	K.20	1631930000	4008190206680	SCHT 5 S	K.15
1276960121	4008190168339	DEK 8 FWZ 121-130	K.22	1358660000	4008190139993	DEK 6 FW 1,3,5,...99	K.20	1633260000	4008190257729	AP VL1.5	I.6
1276960131	4008190164713	DEK 8 FWZ 131-140	K.22	1358760000	4008190095666	DEK 6 FW 2,4,...100	K.20	1633320000	4008190257774	AP VL1.5/PE	I.6
1276960131	4008190164713	DEK 8 FWZ 131-140	K.20	1360000000				1635000000	4008190261948	WS 10/5 MC NEUTRAL	K.11
1276960141	4032248028092	DEK 8 FWZ 141-150	K.20	1368720000	4008190047818	SAKS 2/35	A.26	1635010000	4008190456634	WS 10/5 MC BEDRUCKT	K.11
1276960141	4032248028092	DEK 8 FWZ 141-150	K.22	1370000000				1636530000	4008190297053	ZGB 15	K.17
1277060000	4008190088705	DEK 8 NEUTRAL	K.22	1378160000	4008190183851	ADP 4/300	I.16	1640000000			
1277060000	4008190088705	DEK 8 NEUTRAL	K.20	1380000000				1640740000	4008190279103	WS 8/5 MC NEUTRAL	K.11
1277060000	4008190088705	DEK 8 NEUTRAL	K.9	1381600000	4008190121464	EP 1/BW SAKG32/35 HP/DB	I.5	1640750000	4008190456627	WS 8/5 MC BEDRUCKT	K.11
1277091686	4032248048045	DEK 8 RT NEUTRAL	K.20	1390000000				1646630000	4008190401214	ZS 15/5 MC NEUTRAL	K.11
1277091686	4032248048045	DEK 8 RT NEUTRAL	K.22	1397160000	4008190125899	AP DK4Q	B.34	1646640000	4008190456696	ZS 15/5 MC BEDRUCKT	K.11
1277091687	40081900944537	DEK 8 GE NEUTRAL	K.22	1397160000	4008190125899	AP DK4Q	A.34	1650000000			
1277091687	40081900944537	DEK 8 GE NEUTRAL	K.20	1397160000	4008190125899	AP DK4Q	I.6	1653340001	4008190403805	DEK 8 FW 1-50 TAMPOPR.	K.22
1277091688	40081900944544	DEK 8 GN NEUTRAL	K.22	1397180000	4008190171728	AP DK4Q BL	I.6	1653340051	4008190403812	DEK 8 FW 51-100 TAMPOPR.	K.22
1277091688	40081900944544	DEK 8 GN NEUTRAL	K.20	1397180000	4008190171728	AP DK4Q BL	I.6	1653350001	4008190403843	DEK 8 FS 1-50 TAMPOPR.	K.20
1277091689	40081900944551	DEK 8 VI NEUTRAL	K.22	1398760000	4008190059576	DK 4Q ST WA 2.4	B.40	1653350051	4008190403836	DEK 8 FS 51-100 TAMPOPR.	K.22
1277091689	40081900944551	DEK 8 VI NEUTRAL	K.20	1400000000				1670000000			
1277091690	40081900944568	DEK 8 OR NEUTRAL	K.22	1404520000	4008190170400	SAKC 10/35 1STB4 KRG	A.20	1670290000	4008190430368	WS 10/3,5 NEUTRAL	K.11
1277091690	40081900944568	DEK 8 OR NEUTRAL	K.20	1430000000				1670360000	4008190431242	QVSK 2 SAKT1	I.20
1278460000	4008190086930	SCHT 9/4	K.16	1430760000	4008190132897	ADP 4/1000	I.16	1675350000	4008190450083	KLBU 2X2-6	G.4
1280000000				1440000000				1677140000	4008190475482	MF 8/5 MC NEUTRAL	K.13
1284060000	4008190017347	DK 4Q/35/TC TYP J	A.34	1447260000	4008190144661	WS 10/6 SONDERDRUCK	K.11	1677150000	4008190475499	MF 8/5 MC SONDERDRUCK	K.13
1284160000	4008190033569	DK 4Q/35/TC TYP K	A.34	1570000000				1677160000	4008190475505	MF 10/5 MC NEUTRAL	K.13
1285660000	4008190086060	DK 4Q/35/TC TYP T	A.34	1572000000	4008190177164	DEK 5 FWZ 1-9	K.20	1677170000	4008190475512	MF 10/5 MC SONDERDRUCK	K.13
1286600000	4008190144777	TST 2/M5	H.11	1590000000				1677180000	4008190470579	MF 12/5 MC NEUTRAL	K.13
1287700000	4008190132392	BST 2 BEZEICHNUNGSSTR.	I.17	1592810000	4008190182250	KLBU 4-13.5	G.4	1677190000	4008190470586	MF 12/5 MC SONDERDRUCK	K.13
1287860000	4008190040208	TBS 2	I.17	1593540000	4008190185725	SAKH 35/M.AP.CUN/EP/SW	D.7	1677200000	4008190475529	MF 10/6 MC NEUTRAL	K.13
1287920000	4008190006372	SAKG 46 I/AL	B.59	1595960000	4008190164324	AP DLD2.5/PE	I.6	1677220000	4008190475536	MF 10/6 MC SONDERDRUCK	K.13
1289660001	4008190124656	DEK 8 FSZ 1-10	K.22	1596240000	4008190093570	SAKH 35 EP/SW	D.7	1677230000	4008190475536	MF 10/6 MC SONDERDRUCK	K.13
1289660001	4008190124656	DEK 8 FSZ 1-10	K.20	1598080000	4008190020729	SAKK 4 KER/WS	D.2	1678650000	4008190466763	FK 4	I.14
1289660011	4008190024345	DEK 8 FSZ 11-20	K.20	1598090000	4008190185565	SAKK 10 KER/WS	D.3	1680000000			
1289660011	4008190024345	DEK 8 FSZ 11-20	K.22	1600000000				1681080001	4008190899141	MF 10/5 MC FW 1-50	K.13
1289660021	4008190041700	DEK 8 FSZ 21-30	K.20	1600480000	4008190130589	KLBU 3-8	G.4	1681080051	4008190899158	MF 10/5 MC FW 51-100	K.13
1289660021	4008190041700	DEK 8 FSZ 21-30	K.22	1600490000	4008190151874	KLBU 10-20	G.4	1681080101	4008190899165	MF 10/5 MC FW 101-150	K.13
1289660021	4008190041700	DEK 8 FSZ 21-30	K.22	1609800000	4008190397111	DEK 5/5 MC-10 NEUT. VAR	K.20	1681080151	4008190899189	MF 10/5 MC FW 151-200	K.13
1289660031	4008190022457	DEK 8 FSZ 31-40	K.20	1609801044	4008190397111	DEK 5/5 MC-10 NEUT. WS	K.9	1681191187	4008190292534	MF 10/5 MC GW PE	K.13
1289660031	4008190022457	DEK 8 FSZ 31-40	K.22	1609801044	4008190397111	DEK 5/5 MC-10 NEUT. WS	K.9	1681191187	4008190292534	MF 10/5 MC GW PE	K.13
1289660041	4008190085070	DEK 8 FSZ 41-50	K.20	1609801686	4008190397128	DEK 5/5 MC-10 NEUT. RT	K.20	1681200001	4008190910150	MF 10/5 MC FS 1-50	K.13
1289660041	4008190085070	DEK 8 FSZ 41-50	K.22	1609801687	4008190397135	DEK 5/5 MC-10 NEUT. GE	K.20	1681200051	4008190910167	MF 10/5 MC FS 51-100	K.13
1289660051	4008190074685	DEK 8 FSZ 51-60	K.20	1609801688	4008190397142	DEK 5/5 MC-10 NEUT. GN	K.20	1681200101	4008190910174	MF 10/5 MC FS 101-150	K.13
1289660051	4008190074685	DEK 8 FSZ 51-60	K.22	1609801691	4008190397159	DEK 5/5 MC-10 NEUT. GR	K.20	1681200151	4008190910181	MF 10/5 MC FS 151-200	K.13
1289660061	4008190181598	DEK 8 FSZ 61-70	K.20	1609801693	4008190397166	DEK 5/5 MC-10 NEUT. BL	K.20	1681210001	4008190929558	MF 10/5 MC FSZ 1-10	K.13
1289660061	4008190181598	DEK 8 FSZ 61-70	K.22	1609810000	4008190456597	DEK 5/5 MC BEDRUCKT	K.9	1681210001	4008190929558	MF 10/5 MC FSZ 1-10	K.13
1289660071	4008190026424	DEK 8 FSZ 71-80	K.20	1609810000	4008190456597	DEK 5/5 MC BEDRUCKT	K.9	1681231187	4008190835375	MF 10/5 MC GS PE	K.13
1289660071	4008190026424	DEK 8 FSZ 71-80	K.22	1609820000	4008190203436	DEK 5/6 MC NEUTRAL	K.9	1681240001	4008190944063	MF 10/6 MC FW 1-50	K.13
1289660081	4008190023935	DEK 8 FSZ 81-90	K.20	1609820000	4008190203436	DEK 5/6 MC NEUTRAL	K.20	1681240051	4008190944070	MF 10/6 MC FW 51-100	K.13
1289660081	4008190023935	DEK 8 FSZ 81-90	K.22	1609830000	4008190456603	DEK 5/6 MC BEDRUCKT	K.9	1681240101	4008190944087	MF 10/6 MC FW 101-150	K.13
1289660091	4008190103576	DEK 8 FSZ 91-100	K.20	1609830000	4008190456603	DEK 5/6 MC BEDRUCKT	K.20	1681240151	4008190944094	MF 10/6 MC FW 151-200	K.13
1289660091	4008190103576	DEK 8 FSZ 91-100	K.22	1609840000	4008190203429	DEK 5/6,5 MC NEUTRAL	K.20	1681260001	4008190944339	MF 10/6 MC FWZ 1-10	K.13
1289690000	4008190144159	DEK 8 BEDR./FARBIG	K.20	1609840000	4008190203429	DEK 5/6,5 MC NEUTRAL	K.9	1681271187	4008190935856	MF 10/6 MC FWZ L1,L2-PE	K.13
1289690000	4008190144159	DEK 8 BEDR./FARBIG	K.22	1609850000	4008190456610	DEK 5/6,5 MC BEDRUCKT	K.9	1681341075	4008190943677	MF 10/6 MC GW L1	K.13
1300000000				1609860000	4008190203481	WS 12/5 MC NEUTRAL	K.11	1681341076	4008190943684	MF 10/6 MC GW L2	K.13
1303360000	4008190084950	AKE 2.5	E.4	1609870000	4008190456641	WS 12/5 MC BEDRUCKT	K.11	1681341077	4008190943691	MF 10/6 MC GW L3	K.13
1304860000	4008190030896	DKT 4V 2STB	B.17	1609880000	4008190456672	WS 15/5 MC BEDRUCKT	K.11	1681351187	4008190322748	MF 10/6 MC GW PE	K.13
1304960000	4008190185503	DKT 4V/35 2STB	A.19	1609900000	4008190203467	WS 12/6 MC NEUTRAL	K.11	1681360001	4008190322778	MF 10/6 MC FS 1-50	K.13
1310000000				1609910000	4008190203467	WS 12/6 MC NEUTRAL	K.11	1681360051	4008190322786	MF 10/6 MC FS 51-100	K.13
1312500000	4008190039837	Q 2 DLI	I.11	1609910000	4008190203467	WS 12/6 MC NEUTRAL	K.11	1681360101	4008190322793	MF 10/6 MC FS 101-150	K.13
1312600000	4008190024604	Q 3 DLI	I.11	1609920000	4008190203467	WS 12/6 MC NEUTRAL	K.11	1681360151	4008190322809	MF 10/6 MC FS 151-200	K.13
1312700000	4008190162122	Q 4 DLI	I.11	1609930000	4008190203467						

Order No.	EAN No.	Type	Page
-----------	---------	------	------

1720000000

1720620000	4008190362300	DEK 5/7,5 MC NEUTRAL	K.9
1720620000	4008190362300	DEK 5/7,5 MC NEUTRAL	K.20
1723800000	4008190377038	BS 35II KLBÜ HOLDER	G.10
1723810000	4008190377007	BS 35II KLBÜ3-8	G.10
1723820000	4008190377014	BS 35II/KLBÜ 4-13.5	G.10
1724580000	4008190377717	FM 4.2/TS35	H.11

1740000000

1742630000	4008190980764	BTWZ KLBÜ	G.8
1746130000	4008190986834	SSCH 10X3X1000 ST/ZN	G.5
1746130000	4008190986834	SSCH 10X3X1000 ST/ZN	G.7
1746130000	4008190986834	SSCH 10X3X1000 ST/ZN	G.4
1747350000	4032248003372	TS 35X7.5 2M/CRN	H.9
1749151001	4032248064441	KLBUE CO 3	G.5
1749161001	4032248064458	KLBUE CO 4	G.5
1749430000	4032248013210	BS 35II KLBÜ3-8/2X2-6	G.10

1750000000

1752131001	4032248064434	KLBUE CO 2	G.5
1752681001	4032248044399	KLBÜ 3-8 CPF SS	G.11
1752691001	4032248044429	KLBÜ 4-13.5 CPF	G.11
1752701001	4032248044436	KLBÜ 10-20 CPF	G.11
1752711001	4032248044443	KLBÜ 15-32 CPF	G.11
1752950000	4008190022624	WSH 20 MT	G.7
1753311001	4032248064427	KLBUE CO 1	G.5
1753320000	4032248009015	AP ASK1 DB	I.6
1755081001	4032248064472	KLBUE CO 5	G.5
1755270000	4032248017348	DEK 5/3,5 MC NEUTRAL	K.9
1755270000	4032248017348	DEK 5/3,5 MC NEUTRAL	K.20
1755280001	4032248017392	DEK 5/3,5 MC GW 1	K.20
1755280002	4032248017379	DEK 5/3,5 MC GW 2	K.20
1755280003	4032248017386	DEK 5/3,5 MC GW 3	K.20
1755280004	4032248017393	DEK 5/3,5 MC GW 4	K.20
1755280005	4032248017409	DEK 5/3,5 MC GW 5	K.20
1755280006	4032248017416	DEK 5/3,5 MC GW 6	K.20
1755280007	4032248017423	DEK 5/3,5 MC GW 7	K.20
1755280008	4032248017430	DEK 5/3,5 MC GW 8	K.20
1755280009	4032248017447	DEK 5/3,5 MC GW 9	K.20
1755281000	4032248017454	DEK 5/3,5 MC GW 0	K.20

1760000000

1760720000	4008190068714	BS 35/WSH 2	G.7
1762320001	4032248043552	DEK 5/3,5 MC FSZ 1-10	K.20
1762320011	4032248043569	DEK 5/3,5 MC FSZ 11-20	K.20
1762320021	4032248043576	DEK 5/3,5 MC FSZ 21-30	K.20
1762320031	4032248043583	DEK 5/3,5 MC FSZ 31-40	K.20
1762320041	4032248043590	DEK 5/3,5 MC FSZ 41-50	K.20
1762320051	4032248043606	DEK 5/3,5 MC FSZ 51-60	K.20
1762320061	4032248043613	DEK 5/3,5 MC FSZ 61-70	K.20
1762320071	4032248043620	DEK 5/3,5 MC FSZ 71-80	K.20
1762320081	4032248043637	DEK 5/3,5 MC FSZ 81-90	K.20
1762320091	4032248043644	DEK 5/3,5 MC FSZ 91-100	K.20
1762320101	4032248043651	DEK 5/3,5 MC FSZ 101-110	K.20
1762320111	4032248043668	DEK 5/3,5 MC FSZ 111-120	K.20
1762320121	4032248043675	DEK 5/3,5 MC FSZ 121-130	K.20
1762320131	4032248043682	DEK 5/3,5 MC FSZ 131-140	K.20
1762320141	4032248043689	DEK 5/3,5 MC FSZ 141-150	K.20
1767090000	4032248112906	SPEEDMARKING-LASER	K.18
1767730000	4032248102532	DEK 5/3,5 MC bedruckt	K.9
1767730000	4032248102532	DEK 5/3,5 MC bedruckt	K.20
1768020000	4032248109296	BS 35II KLBÜ2X3-8/2X2-6	G.10
1768090000	4032248106271	WS 14/5 MC neutral	K.11

1770000000

1770070000	4032248117468	Toner für Speedmarking-Laser	K.18
1770490000	4032248119738	DEK 5/7,5 MC Sonderdruck	K.9
1773330001	4032248140855	WS 12/5 FWZ 1-10	K.10
1773330011	4032248140879	WS 12/5 FWZ 11-20	K.10
1773330021	4032248140886	WS 12/5 FWZ 21-30	K.10
1773330031	4032248140893	WS 12/5 FWZ 31-40	K.10
1773330041	4032248140909	WS 12/5 FWZ 41-50	K.10
1773360000	4032248140961	WS 8/5 Sonderdr. Laser	K.10
1773370000	4032248140978	WS 10/5 Sonderdr. Laser	K.10
1773380000	4032248140985	WS 12/5 Sonderdr. Laser	K.10
1773410000	4032248141111	AP 100 GR	I.6
1773430001	4032248141326	WS 12/5 FSZ 1-10	K.10
1773430011	4032248141333	WS 12/5 FSZ 11-20	K.10
1773430021	4032248141340	WS 12/5 FSZ 21-30	K.10
1773430031	4032248141357	WS 12/5 FSZ 31-40	K.10
1773430041	4032248141364	WS 12/5 FSZ 41-50	K.10
1778270000	4032248161041	WS 12/3,5 MC neutral	K.11
1778280000	4032248161058	WS 12/3,5 MC Sonderdr.	K.11
1779100000	4032248169894	TSTW 5/M5 ZN	H.11

1780000000

1782880000	4032248179527	Magazin SMark Laser	K.18
1783550000	4032248189847	AP DLD2.5 DB	I.6
1783800000	4032248189830	AP DLD2.5/PE DB	I.6
1784150000	4032248190140	AP VLI1.5 DB	I.6
1784160000	4032248190157	AP VLI1.5/PE DB	I.6

Order No.	EAN No.	Type	Page
-----------	---------	------	------

1784210000	4032248189878	AP DLD2.5 DB	I.6
1784390000	4032248259694	SAK 16/EN BL	C.3
1784400000	4032248259700	SAK 35/EN BL	C.4
1784410000	4032248259717	SAK 10/EN BL	C.3

1790000000

1790080000	4032248214105	AP 110 GR	I.6
1792000000	4032248223862	WS 10/5 MC Midd. Neutr.	K.11
1792010000	4032248223879	WS 10/5 MC Midd. Sonder	K.11
1797460000	4032248238682	Tintenpatrone PrintJet	K.19

1800000000

1802690000	4032248257201	TS 27X12.5M/ST/FZN	G.11
1805480000	4032248270224	BZT 2 WS 10/5	K.14
1805490000	4032248270231	BZT 1 WS 10/5	K.14
1805520000	4032248270248	BZT 1 ZA WS10/5	K.14
1805530000	4032248270255	BZT 2 ZA WS 10/5	K.14
1805880000	4032248273614	Snap Mark I	K.14
1806120000	4032248275298	EM 8/30	K.17
1806630000	4032248276813	IS2 KG	J.24
1806650000	4032248276820	IS 3 KG	J.24
1806660000	4032248276837	IS 4 KG	J.24

1810000000

1813090000	4032248296521	Magazin PrintJet	K.19
1814660000	4032248302956	ZF 4 S BL	H.5
1814670000	4032248302963	ZF 4 S GN/GE	H.5
1814680000	4032248302949	ZF 4 S	H.5
1816240000	4032248306190	MF 5/5 Mini MC NEUTRAL	K.13
1816250000	4032248306206	MF 5/5 MC NEUTRAL	K.13
1816260000	4032248306183	MF 5/6 MC NEUTRAL	K.13
1816270000	4032248306312	MF 5/5 MC NEUTRAL	K.13
1816280000	4032248306329	MF 9/5F MC NEUTRAL	K.13
1816290000	4032248306366	MF 9/6 MC NEUTRAL	K.13
1816310000	4032248306589	MF 5/5 Mini MC SONDERDR	K.13
1816320000	4032248306602	MF 5/5 MC SONDERDRUCK	K.13
1816330000	4032248306596	MF 5/6 MC SONDERDRUCK	K.13
1816340000	4032248306718	MF 9/5 MC SONDERDRUCK	K.13
1816350000	4032248306725	MF 9/5F MC SONDERDRUCK	K.13
1816360000	4032248306732	MF 9/6 MC SONDERDRUCK	K.13
1818400000	4032248310876	WS 10/6 MC Midd. Neutr.	K.11
1818410000	4032248310883	WS 10/6 MC Midd. Sonder	K.11

1820000000

1820200000	4032248313334	AP SAKR BE RS-SET	I.6
1828450000	4032248350513	WS 10/6 MC NEUTRAL	K.11
1828460000	4032248367399	WS 10/6 MC Sonderdruck	K.11

1840000000

1848290000	4032248385614	TS 35X15/2.3 2M/AL/BK	H.9
------------	---------------	-----------------------	-----

1850000000

1853970000	4032248389445	AP SAK4-10 GR 7042	I.6
1854490000	4032248393556	DEK 5/5 Plus MC Neutral	K.9
1856740000	4032248400850	DEK 5/8 MC Neutral	K.9
1858920000	4032248410651	Tintentank PrintJet II	K.19
1858950000	4032248410668	CleanUnit PrintJet II	K.19
1858980000	4032248410002	PrintJet II 115V	K.19
1858990000	4032248410811	PrintJet II 230V	K.19

2010000000

2012770000	4008190236823	AP STA2.5 0.5MM	I.6
------------	---------------	-----------------	-----

2070000000

2076890000	4032248424719	AP SAK4-10 GE	I.6
2076900000	4032248424726	AP SAK16 GE	I.6
2076910000	4032248424733	AP SAK35/TW SAK16 GE	I.6
2077060000	4032248424757	AP AST3+4/35 GE	I.6
2077070000	4008190469535	AP AKZ4	I.6

2090000000

2093550000		AP ATA1	I.6
------------	--	---------	-----

2110000000

2119490000	4008190219017	AP 2 DSG1.5T	I.6
------------	---------------	--------------	-----

2140000000

2144900000	4008190241797	AP SAK2.5/35	I.6
------------	---------------	--------------	-----

3830000000

3835020000	4008190971885	PPT/35	D.9
3835120000	4008190003364	AP PPT/35	I.6

Order No.	EAN No.	Type	Page
-----------	---------	------	------

3890000000

3896100000	4008190857851	SP 15	G.9
3896200000	4008190850234	SP 20	G.9
3896300000	4008190850241	SP 30	G.9

4060000000

4062150000	4032248297078	PJ-Clean Unit	K.19
------------	---------------	---------------	------

4140000000

4140450000	4008190261740	AP SAKB/C/T BE	I.6
4145220000	4008190401528	AP RV	I.6

4170000000

4173520000	4008190233143	AP SAKB/C/T1 DB	I.6
------------	---------------	-----------------	-----

6380000000

6382670000	4008190549510	SAKRF/35	A.38
------------	---------------	----------	------

7900000000

Order No.	EAN No.	Type	Page	Order No.	EAN No.	Type	Page	Order No.	EAN No.	Type	Page
9004310000	4008190179298	H0,75/14T HELLBLAU BD	J.10	9008870000	4032248266623	SK-S 2,0-8,0 MR	J.20	9019160000	4008190028732	H2,5/14D BLAU	J.9
9004320000	4008190167523	H1/14 GELB BD	J.9	9008880000	4032248266630	TR-S 9-40	J.20	9019170000	4008190178024	H2,5/18D BLAU	J.10
9004330000	4008190047498	H1/14D ROT BD	J.10	9008890000	4032248266661	SDIK P22	J.16	9019170000	4008190178024	H2,5/18D BLAU	J.9
9004330000	4008190047498	H1/14D ROT BD	J.10	9008900000	4032248266685	SDIK P21	J.16	9019180000	4008190101145	H2,5/20D BLAU	J.10
9004340000	4008190080723	H1,5/14 ROT BD	J.9	9008910000	4032248266692	SK1 1,0x4,5x125	J.16	9019180000	4008190101145	H2,5/24D BLAU	J.9
9004350000	4008190005474	H1,5/14D SCHWARZ BD	J.10	9008920000	4032248266715	SK1 13,0x125	J.16	9019190000	4008190141349	H4/17D GRAU	J.10
9004350000	4008190005474	H1,5/14D SCHWARZ BD	J.10	9008930000	4032248266722	SK1 11,0x125	J.16	9019190000	4008190141349	H4/17D GRAU	J.9
9004360000	4008190083397	H2,5/14D BLAU BD	J.9	9008940000	4032248266739	SK1 10,0x126	J.16	9019200000	4008190126575	H4/20D GRAU	J.9
9004360000	4008190083397	H2,5/14D BLAU BD	J.9	9008950000	4032248266753	SK1 9,0x126	J.16	9019200000	4008190126575	H4/20D GRAU	J.10
9004370000	4008190052508	H2,5/14T GRAU BD	J.10	9008960000	4032248266760	SK1 8,0x127	J.16	9019210000	4008190002336	H4/26D GRAU	J.10
9004390000	4008190881016	H0,34/12 TÜRKIS BD GSP	J.9	9008970000	4032248266777	SK1 7,0x127	J.16	9019210000	4008190002336	H4/26D GRAU	J.9
9004410000	4008190009397	H1,5/16 ZH ROT SV	J.11	9008980000	4032248266784	SK1 6,0x128	J.16	9019220000	4008190151607	H6/20D GELB	J.10
9004420000	4008190167455	H1,5/16D ZH SCHWARZ SV	J.12	9008990000	4032248266791	SK1 5,5x128	J.16	9019230000	4008190072117	H6/20D GELB	J.10
9004430000	4008190099367	H2,5/18,5D ZH BLAU SV	J.11	9009000000	4032248266814	SK1 5,0x129	J.16	9019240000	4008190075385	H10/22D ROT	J.10
9004430000	4008190099367	H2,5/18,5D ZH BLAU SV	J.12	9009010000	4032248266869	SD 1,2x6,5x150	J.18	9019250000	4008190041410	H10/28D ROT	J.10
9004440000	4008190198473	H0,5/15 ZH ORANGE SV	J.11	9009020000	4032248266883	SD 0,8x4,5x125	J.18	9019260000	4008190125806	H16/24D BLAU	J.10
9004500000	4008190053925	WAW 1 NEUTRAL	J.3	9009030000	4032248266944	SD 0,4x2,5x75	J.18	9019270000	4008190100773	H16/28D BLAU	J.10
9004510000	4008190111182	WAW 2	J.3	9009040000	4032248266968	SK 13,0x125	J.18	9019280000	4008190038380	H25/30D GELB	J.10
9004560000	4008190286132	H0,5/14S TRI ORANGE	J.12	9009050000	4032248267002	SK 12,0x125	J.18	9019300000	4008190054984	H25/36D GELB	J.10
9004590000	4008190862060	H0,5/14S TRI WEISS	J.12	9009060000	4032248267019	SK 11,0x125	J.18	9019310000	4008190102234	H35/30D ROT	J.10
9004710000	4032248044221	H10/26D ROT ZH SV	J.12	9009070000	4032248267026	SK 10,0x125	J.18	9019320000	4008190111847	H35/30D ROT	J.10
9004720000	4008190962210	H6/25D GELB ZH SV	J.12	9009080000	4032248267040	SK 9,0x125	J.18	9019330000	4008190048365	H35/39D ROT	J.10
9004730000	4008190161811	H4/22D GRAU ZH/SV	J.12	9009090000	4032248267057	SK 8,0x125	J.18	9019340000	4008190067632	H50/36D BLAU	J.10
9004730000	4008190161811	H4/22D GRAU ZH/SV	J.11	9009100000	4032248267064	SK 7,0x125	J.18	9019350000	4008190049263	H50/40D BLAU	J.10
9004740000	4008190031923	H2,5/20,5D BLAU ZH SV	J.12	9009110000	4032248267071	SK 6,0x125	J.18	9019400000	4008190066204	H0,5/14D WEISS SV	J.10
9004740000	4008190031923	H2,5/20,5D BLAU ZH SV	J.11	9009120000	4032248267088	SK 5,5x125	J.18	9019410000	4008190164096	H0,75/14D GRAU SV	J.10
9004750000	4008190055431	H1,5/20D SCHWARZ ZH SV	J.12	9009130000	4032248267095	SK 5,0x125	J.18	9019420000	4008190189099	H1/14D ROT SV	J.10
9004760000	4008190160951	H1,0/20D ROT ZH SV	J.12	9009140000	4032248267101	SDTR 30	J.18	9019430000	4008190107420	H1,5/14D SCHWARZ SV	J.10
9004770000	4008190038816	H0,75/17D GRAU ZH SV	J.12	9009150000	4032248267118	SDTR 25	J.18				
9004780000	4008190188481	H0,5/15D WEISS ZH SV	J.12	9009160000	4032248267125	SDTR 20	J.18				
9004900000	4008190482671	H0,75/17 ZH WEISS SV	J.11	9009170000	4032248267149	SDTR 15	J.18				
9004910000	4008190482688	H1,0/20 ZH GELB SV	J.11	9009180000	4032248267156	SDTR 10	J.18				
9004920000	4008190482695	H1,5/20 ZH ROT SV	J.11	9009190000	4032248267163	SDTR 8	J.18				
9004930000	4008190482701	H6,0/25 ZH SCHWARZ SV	J.11	9009640000	4032248267835	SDIT 10	J.16				
9004940000	4008190482718	H10,0/26 ZH ELFENBEINSV	J.11	9009650000	4032248267842	SDIT 15	J.16				
9005000000	4008190072506	STRIPAX	J.4	9009660000	4032248267859	SDIT 20	J.16				
9005140000	4008190482725	H0,75/17T ZH HELLBLAU SV	J.12	9009670000	4032248267866	SDIT 25	J.16				
9005150000	4008190482732	H2,5/20,5 T ZH GRAU SV	J.12	9009680000	4032248267873	SDIT 30	J.16				
9005160000	4008190482749	H6,0/25T ZH GRÜN SV	J.12	9009690000	4032248267880	SDIT 40	J.16				
9005170000	4008190482756	H10,0/26T ZH BRAUN SV	J.12	9009700000	4032248267914	SD STK 8x150	J.19				
9005180000	4008190859909	H014/10 GRAU SV	J.9	9009710000	4032248267958	SD STK 10x175	J.19				
9005610000	4008190183875	STRIPAX 16	J.4	9009720000	4032248267965	SDS TR8-30	J.19				
9005810000	4008190275877	H0,5/14 ORANGE BD GSP	J.9	9009730000	4032248267972	SDIS 2,5-5,5/PH1/2	J.17				
9005820000	4008190275884	H0,75/14 WEISS BD GSP	J.9	9009740000	4032248267996	SDS 2,5-5,5/PH1/2	J.19				
9005830000	4008190275891	H1,0/14 GELB BD GSP	J.9	9009750000	4032248268011	System 11+1	J.19				
9005840000	4008190275907	H1,5/14 ROT BD GSP	J.9	9009760000	4032248268016	System 11+1 Secur.	J.19				
9005850000	4008190275914	H2,5/14D BLAU BD GSP	J.10								
9005850000	4008190275914	H2,5/14D BLAU BD GSP	J.9								
9005860000	4008190275921	H0,5/14D WEISS BD GSP	J.10								
9005870000	4008190275938	H0,75/14 GRAU BD GSP	J.10								
9005880000	4008190275945	H1,0/14D ROT BD GSP	J.10								
9005890000	4008190275952	H1,5/14D SCHWARZ BD GSP	J.10								
9005900000	4008190275969	H0,75/14T BLAU BD GSP	J.10								
9005910000	4008190275976	H2,5/14T GRAU BD GSP	J.10								
9005990000	4008190085964	PZ 1,5	J.8								
9006020000	4032248257409	swifty	J.15								
9006060000	4032248257638	SWIFTY SET	J.15								
9006120000	4008190044527	CTI 6	J.8								
9006210000	4008190166694	CTI 6 S	J.8								
9006450000	4008190095796	PZ 50	J.8								
9006450000	4008190095796	PZ 50	J.6								
9006590000	4008190332259	H1,5/17,5X SCHWARZ SV	J.11								
9006630000	4008190332266	H1,5/19,5X SCHWARZ SV	J.11								
9006670000	4008190332273	H2,5/17,5X BLAU SV	J.11								
9006710000	4008190332280	H2,5/21,5X BLAU SV	J.11								
9006750000	4008190332297	H4,0/19,5X GRAU SV	J.11								
9006790000	4008190332303	H6,0/23,0X GELB SV	J.11								
9006830000	4008190332310	H10,0/24,5X ROT SV	J.11								
9006870000	4008190332327	H16,0/25,5X BLAU SV	J.11								
9007440000	4008190044987	DMS 3	J.13								
9007470000	4008190299224	DMS 3 SET 1	J.13								
9007480000	4008190045298	DMS 3 SET 2	J.13								
9008320000	4032248056262	SD 0,3x3,0x80	J.18								
9008330000	4032248056286	SD 0,6x3,5x100	J.15								
9008330000	4032248056286	SD 0,6x3,5x100	J.18								
9008340000	4032248056293	SD 0,8x4,0x100	J.18								
9008350000	4032248056316	SD 1,0x5,5x150	J.18								
9008370000	4032248056330	SDI 0,4x2,5x75	J.16								
9008380000	4032248056347	SDI 0,5x3,0x100	J.16								
9008390000	4032248056354	SDI 0,6x3,5x100	J.16								
9008400000	4032248056361	SDI 0,8x4,0x100	J.16								
9008410000	4032248056378	SDI 1,0x5,5x125	J.16								
9008420000	4032248056385	SDI 1,2x6,5x150	J.16								
9008430000	4032248056392	SDI 1,6x8,0x175	J.16								
9008450000	4032248056446	SDIZO 6,3X,5X100	J.24								
9008460000	4032248056453	SDIZO 8,4X,0X100	J.24								
9008470000	4032248056460	SDK PH0	J.18								
9008480000	4032248056477	SDK PH1	J.18								
9008490000	4032248056484	SDK PH2	J.18								
9008500000	4032248056491	SDK PH3	J.18								
9008520000	4032248056514	SDK PZ0	J.18								
9008530000	4032248056521	SDK PZ1	J.18								
9008540000	4032248056538	SDK PZ2	J.18								
9008550000	4032248056545	SDK PZ3	J.18								
9008560000	4032248056552	SDIK PH0	J.16								
9008570000	4032248056569	SDIK PH1	J.16								
9008580000	4032248056576	SDIK PH2	J.16								
9008590000	4032248056590	SDIK PH3	J.16								
9008850000	4032248266609	SK WSD-S 1,5-10,0	J.20								
9008860000	4032248266616	SK-S 2,0-8,0	J.20								
				9010110000	4032248300754	SD 0,6x3,5x200	J.18				

PCB Terminals and Connectors

CATALOGUE

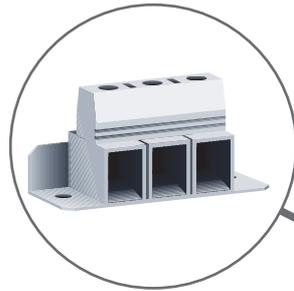

PCB-Terminals

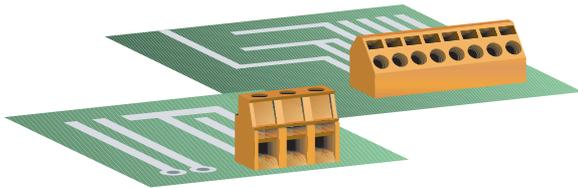

PCB-pluggable Terminals

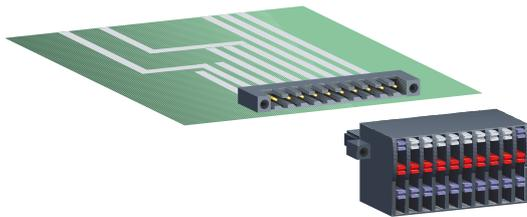

Tools



Electrical Cabinet Products

Power Supply, Overvoltage Protection



Relay Couplers, Opto Couplers, Time Relays, Signal Converters, Interface Converters, Interface Units



CATALOGUE



Terminals
- Screw Connection
Bolt Terminals

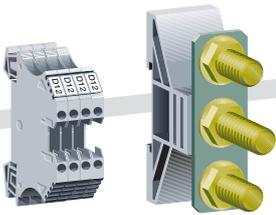

Terminals
- Tension Clamp
- Insulation Displacement
Connection IDC
- Direct Push In

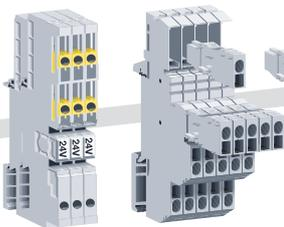

Marking Systems

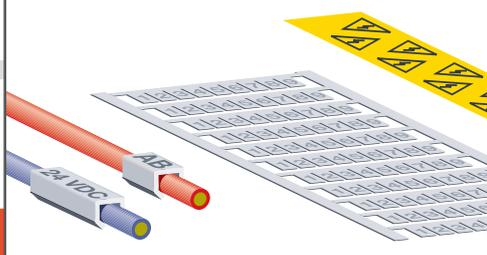

Field Wiring Products

CATALOGUE



Heavy Duty Connectors

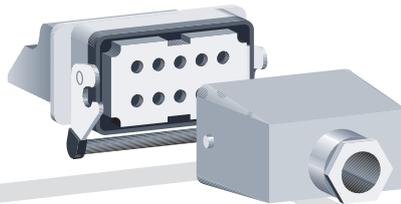

**Housing,
Cable Inlets**

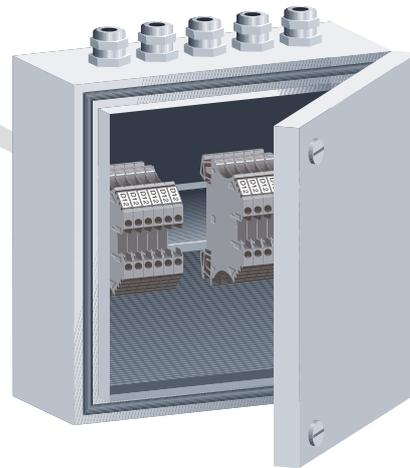

Sensor Actuator Interface SAI

- Distributors
- Male, Female
- Sensor Cables

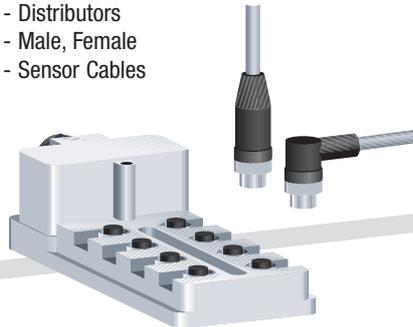

Fieldbus-Components

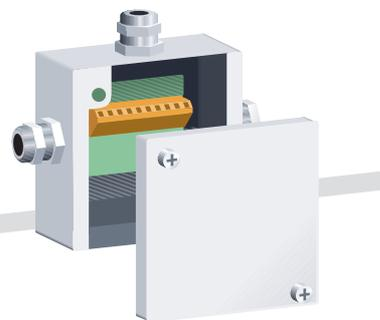

Sensors / Actuators

Worldwide activities

A Austria
Weidmüller Ges.m.b.H.
Industriezentrum Nö Süd
Straße 2, Objekt M2
2355 Wiener Neudorf
Phone +43 2236 6708-0
Fax +43 2236 6708-199
office.at@weidmueller.com

ADN Yemen
Please contact
Weidmüller Middle East
United Arab Emirates

AUS Australia
Weidmüller Pty. Ltd.
43 Huntingwood Drive
Huntingwood,
NSW, 2148
P.O.Box 6944
Blacktown
NSW, 2148
Phone +61 2 9671-9999
Fax +61 2 9671-9911
info@weidmuller.com.au
www.weidmuller.com.au

B Belgium
Weidmüller Benelux B.V.
Ambachtenlaan 11 A
3001 Heverlee
Phone +32 16 395990
Fax +32 16 401051
info@weidmueller.be

BG Bulgaria
Weid-Bul eOOD
ul. Nezabravka 33 A,
bl. 315/3/10
1113 Sofia
Phone +359 2 9632560
Fax +359 2 9631098
weidbul@nat.bg

BIH Bosnia-Herzegovina
BH ES Elektrosistem d.o.o.
ul. J. Veselinovica 18
78000 Banja Luka
Bosna
Phone +387 51 317500
Fax +387 51 317500
elsist@inecco.net
www.elektrosistem.co.yu

BR Brazil
Conexel Conexoes Elétricas Ltda.
Rua Garcia Lorca, 176- V. Paulicéia,
09695-900, Sao Bernardo do
Campo - SP, Brasil
Phone +55 11 43669600
Fax +55 11 43621677
vendas@conexel.com.br
www.conexel.com.br

BRN Bahrain
Khayber Trading Company
P.O. Box 1976 Manama,
Bahrain
Phone +973 720 747
Fax +973 720 331
khayber@batelco.com.bh

BY Belarus
TECHNIKON Ltd.
Oktyabrskaya Str. 16/5
Apt. 704
220030 Minsk
Belarus
Tel. +375 17 2104626
Fax +375 17 2275830
technikon@belsonet.net

CDN Canada
W Interconnections Canada Inc.
10 Spy Court, Markham,
Ontario L3 R5 H6
Phone +1 905 475-1507
Fax +1 905 475-5855
info1@weidmuller.ca
www.weidmuller.ca

CH Switzerland
Weidmüller Schweiz AG
Rundbuckstrasse 2
8212 Neuhausen am Rheinfall
Phone +41 52 6740707
Fax +41 52 6740708
mail.info@weidmueller.ch
www.weidmueller.ch

CN China
Weidmüller Interface
(Suzhou) Co. Ltd,
Standart Factory Building 6,
Area 3 of New Technology Park,
Xiangyang Road No.81,
Suzhou New District,
Suzhou 215011 Jiangsu Province,
P.R. China
Phone +86 21 50462384
Fax +86 21 50462282
www.cnweidmuller.com

CO Columbia
Automatizacion Avanzada S. A.
Carrera 97 No. 42 A-23 B3,
Santafe de Bogotá Colombia.
Phone +57 1 4132048
Fax +57 1 4159788
mgallegos@
automatizacionavanzada.com

CR Costa Rica
ELVATRON S.A.
400 metros Norte de la Agencia del
Banco de Costa Rica en la Uruca,
San José, Costa Rica
Phone +506 2 961060
Fax +506 2 326071
dirk.haase@elvatron.com

CZ Czech Republic
Weidmüller s. r. o.
Videnska ul. 340
25242 Vestec u Prahy
Phone +420 2 44001400
Fax +420 2 44001499
office@weidmueller.cz

D Germany
Weidmüller GmbH & Co. KG
Ohmstraße 9
32758 Detmold
Phone +49 5231 1428-0
Fax +49 5231 1428-116
weidmuller@weidmueller.de
www.weidmueller.de

DK Denmark
Knud Wexøe A/S
Skaettekaeret 11
P.O. Box 152
2840 Holte
Phone +45 45465800
Fax +45 45465801
wexoe@wexoe.dk

E Spain
Weidmüller S. A.
Narcis Monturiol 11-13
Pol.Ind. Sudoeste
08960 Sant Just Desvern
Barcelona
Phone +34 93 4803386
Fax +34 93 3718055
weidmuller@weidmuller.es
www.weidmuller.es

ES El Salvador
Please contact
ELVATRON S. A., Costa Rica

EST Estonia
Alter Electric OÜ
Türi 6, 11313 Tallinn, Estonia
Phone +372 65 19 666
Fax +372 65 19667
alter@alter.ee

ET Egypt
Standard Electric
5, Heliopolis Hospital Street,
Cairo, Egypt
Phone +20 2 6444182
Fax +20 2 6444191
stdelec@click.com.eg

F France
Weidmüller Sarl
12, Chaussée Jules César
B.P. 263 Osny
95523 CERGY PONTOISE Cedex
Phone +33 1 34245500
Fax +33 1 34245501
mail@weidmuller.fr
www.weidmueller.com

FIN Finland
JUHA-ELEKTRO OY
Kylvöpolku 6
P. O. Box 57
00681 Helsinki
Phone +358 9 478411
Fax +358 9 47841311

GB United Kingdom
Weidmuller Ltd.
1 Abbey Wood Road
Kings Hill
West Malling
Kent ME19 4YT
Phone +44 1732 877032
Fax +44 1732 873873
info@weidmuller.co.uk
www.weidmueller.com

GCA Guatemala
Please contact
ELVATRON S. A., Costa Rica

GR Greece
Electrorama S.A.
1 An. Martali Str.
41335 Larissa
Phone +30 2410 552533
Fax +30 2410 283463
valvizos@electrorama.com.gr

H Hungary
Weidmüller Kereskedelmi Kft
Dombóvári út 13
1117 Budapest
P. O. Box 22
1507 Budapest
Phone +36 1 464-7888
Fax +36 1 3827701
info@weidmueller.hu

HK Hong Kong
United Equity Limited
Suite B, 11/F International Industrial
Centre
2-8 Kwei Tei Street, Fotan
Shatin, N. T.
Phone +852 26876739
Fax +852 26876735

HKJ Jordan
Please contact
Weidmüller Middle East
United Arab Emirates

HO Honduras
Please contact
ELVATRON S. A., Costa Rica

HR Croatia
Elektro Partner d.o.o.
Radnicka cesta 22
10000 Zagreb
Phone +385 1 6184793
Fax +385 1 6184795
elektropartner@zg.htnet.hr

I Italy
Weidmüller S.r.l.
Via Albert Einstein 4
20092 Cinisello Balsamo
Milano
Phone +39 02 660681
Fax +39 02 6124945
weidmuller@weidmuller.it
www.weidmuller.it

IL Israel
A.U. Shay Ltd.
Embar Street 23/25
P.O.Box 10049
Petach-Tikva 49222
Phone +972 3 9233601
Fax +972 3 9234601
shay@uriel-shay.com

IND India
Weidmüller Representative office
Vijay Dattani
119, Prashanth Extention
Whitefield
Bangalore - 560 066
Phone +91 80 8453999
Fax +91 80 8453999

IR Iran
TAF Co.
72, Iranshahr Av.
Unit 5,
Teheran
Phone +98 21 831-7851
Fax +98 21 882-0268
tafco@safineh.net

IRL Ireland
A.P. Haslam Ltd.
14 Sunshine Ind. Estate
Crumlin Road
Dublin 12
Phone +353 1 453-2522
Fax +353 1 453-2949
paul.haslam@aphaslam.ie

IS Iceland
Samey Automation Center
Lyngas 13, 210 Garoabaer,
Island
Phone +354 510 5200
Fax +354 510 5201
samey@samey.is

J Japan
Nihon Weidmüller Co. Ltd.
Asahi Seimei Bldg. 11F
1-14-1 Fuchicho Fuchu-shi
Tokyo 183-0055 Japan
Phone +81 42 330-7891
Fax +81 42 330-7895
www.weidmuller.co.jp

KWT Kuwait
NOURI Industrial Establishment Co.
P.O.Box 2829,
Safat 13029 Kuwait
Phone +965 4333355
Fax +965 4344085
contact@nie-kwt.com

L Luxembourg
Please contact
Weidmüller Belgium, Heverlee

LT Lithuania
ELEKTROS IRANGA
Tinklu g.29a, 5319 Panevezys,
Lithuania
Phone +370 45582828
Fax +370 45582727
info@eliranga.lt

LV Latvia
Elektrosistemas
Kuldigas St. 51,
1046 Riga, Latvia
Phone +371 7070140
Fax +371 7070141
edgars.vilkins@elektrosistemas.lv

MA Morocco
Energy-Technics Transfer, S.A.
23 Boulevard Lieutenant
Mohamed El Bakai Tamri
Casablanca 20250
Phone +212 2 343700
Fax +212 2 343699

Worldwide activities

- MAL** **Malaysia**
Weidmüller (Malaysia) Sdn. Bhd.
22 Jalan PJS 11/16 Bandar Sunway,
46150 Petaling Jaya,
Selangor Darul Ehsan
Phone +60 3 56337363
Fax +60 3 56336562
- MEX** **Mexico**
W Interconnections, S.A. de C.V.
Av. Ingenieros Civiles No. 204-B,
Conjunto Industrial Chachapa
72990 Chachapa,
Puebla Mexico
Phone +52 222 2866247/48/49
Fax +52 222 2866242
clientes@weidmuller.com.mx
- MK** **Macedonia**
ES MK Elektrosistem d.o.o.
Ul. Bulevar III makedonske brigade bb
91000 Skoplje
Macedonia
Phone +389 91 460295
Fax +389 91 460298
elektrosistem-mk@mt.net.mk
- N** **Norway**
Siv. Ing. J. F. Knudtzen A/S
Billingstadsletta 97
1396 Billingstad
P.O. Box 160
1378 Nesbru
Phone +47 66 983350
Fax +47 66 980955
patorgersbraaten@jfkknudtzen.no
- NIC** **Nicaragua**
Please contact
ELVATRON S. A., Costa Rica
- NL** **Netherlands**
Weidmüller Benelux B.V.
Franciscusweg 221
1216 SE Hilversum
Postbus 1505
1200 BM Hilversum
Phone +31 35 6261261
Fax +31 35 6234569
info@weidmuller.nl
www.weidmuller.nl
- NZ** **New Zealand**
Cuthbert S. Steward Limited
27 Te Puni Street
POB 38496 Petone
Petone, Wellington
Phone +64 4 5686156
Fax +64 4 5686056
- OM** **Oman**
Please contact
Weidmüller Middle East
United Arab Emirates
- P** **Portugal**
Weidmüller - Sistemas de
Interface, S. A.
Estrada Outeiro Polima, Lote B,
N° B2, Escritório 2 - Abóboda
2785-518 Sao Domingos de Rana
Phone +351 21 4459190
Fax +351 21 4455871
weidmuller@mail.telepac.pt
www.weidmuller.pt
- PA** **Panama**
Please contact
ELVATRON S. A., Costa Rica
- PE** **Peru**
DIN AUTOMATIZACION S. A.
Rimac Pampa 385 - Maranga
Lima 32
Phone +51 1 4511733
Fax +51 1 4491095
din_aut@terra.com.pe
- PK** **Pakistan**
Access Technology Networks
(ATN) Pvt Ltd.
No 47 College Road
Sector F-7/2
Islamabad
Phone +92 51 275698
Fax +92 51 275665
- PL** **Poland**
Weidmüller Sp. z o.o.
ul. Golezdzinowska 10
03-302 Warszawa
Poland
Phone +48 22 5100940
Fax +48 22 5100941
- Q** **Qatar**
Please contact
Weidmüller Middle East
United Arab Emirates
- RA** **Argentina**
CPI SA
Bauness 2660
1431 Buenos Aires
Phone +54 11 45238008
Fax +54 11 45220546
cpi@satlink.com
- RC** **Taiwan**
Fittatek Corp., Ltd.
12 F No. 185 Fu-Kuo Rd,
Tso Ying Dist,
Kaohsiung, Taiwan R.O.C.
Phone +886 7556-0858
Fax +886 7556-3279
- RCH** **Chile**
Felipe Bahamondes S.A./ATS AGRO
Servicios Agroindustriales
Maria Luisa Santander 0475
Providencia
Casilla 3425
Santiago
Phone +56 2 341-1271
Fax +56 2 341-1275
felipe@mailblocks.com
- RI** **Indonesia**
P. T. Nego Electrindo
Komplek Perkantoran Kramat Centre
Blok-A 18 Jl Kramat Raya No. 7-9
Jakarta 10450
Phone +62 21 3156218
Fax +62 21 3156219
- RL** **Lebanon**
Please contact
Weidmüller Middle East
United Arab Emirates
- RO** **Romania**
ROMINTERFACE IMPEX SRL
Splaiul Unirii nr. 45, Bl. M 15
sc. 3, ap. 68-69, Sect. 3
74342 Bucuresti
Phone +40 1 3220230
Fax +40 1 3228857
romint@dnt.ro
- ROK** **South Korea**
Weidmüller (Korea) Co., Ltd.
Ocean tower 5F, 760-3,
Woo-1dong, Haeundae-gu, Pusan
Phone +82 51 5564661
Fax +85 51 5567408
- RP** **Philippines**
Tradepoints, Inc.
3rd Floor PM Santiago Bldg.
5081 P. Burgos Cor.,
San Mateo Streets
Makati Manila
Phone +63 2 8993294
Fax +63 2 8993306
- RUS** **Russia**
Weidmüller Representative office
Shabolovka street 2
119049 Russia, Moscow
Phone +7 095 771-6940
Fax +7 095 771-6941
info@weidmueller.ru
www.weidmueller.ru
- S** **Sweden**
Weidmüller AB
Stockholm, Arenavägen 39,
12177 Johanneshov
P.O. Box 10120
12128 Stockholm-Globen
Phone +46 771 43 00 44
Fax +46 8 7272480
mail.stockholm@weidmuller.se
- SA** **Saudi Arabia**
Al Abdulkarim Trading
P.O. Box 5777, Dammam
31432 Saudi Arabia
Phone +966 3 833-7110
Fax +966 3 833-8242
info@akte.com.sa
- SA** **Saudi Arabia**
Saudi Electric Supply Co.
P.O. Box 3298, Al Khobar
31952 Saudi Arabia
Phone +966 3 882-9546227
Fax +966 3 882-9547
customer.service@sesco-ge.com
- SGP** **Singapore**
Weidmüller Pte. Ltd.
Cititech Building
629 Aljunied Road #05-05
Singapore 389838
Phone +65 6841 5311
Fax +65 6841 5377
sales@weidmuller.com.sg
www.weidmuller.com.sg
- SK** **Slovakia**
Elektris s.r.o.
Racianska 188
SK 83153 Bratislava, Slovakia
Phone +421 2 49200113
Fax +421 2 44680328
weidmueller@computel.sk
- SLO** **Slovenia**
ELEKTROPOJJI d.o.o.
Stegne 25
1000 Ljubljana
Phone +38 6 15113810
Fax +38 6 15111604
elektropojji@siol.net
- SYR** **Syria**
Please contact
Weidmüller Middle East,
United Arab Emirates
- T** **Thailand**
Pisanu Engineering &
Construction Co. Ltd.
800/2 Asoke-Dindaeng
Road Dindaeng
Bangkok 10400
Phone +66 2 2459113
Fax +66 2 2463214
pisanu@kanit.co.th
- TR** **Turkey**
Weidmüller Elektronik Ticaret Ltd.
Sirketi
Kore Sehitteri Cad. 34/1-7
80300 Zincirlikuyu - Istanbul
Phone +90 212 2730830
Fax +90 212 2740874
info@weidmuller.com.tr
- UA** **Ukraine**
TEKO Interface
Per.Industrialny 2
03056 - Kiev
Phone +380 04463 57760
Fax +380 04463 91082
elektro@panko.kiev.ua
- UAE** **U.A.E. United Arab Emirates**
Weidmüller Middle-East
P.O. Box 62448
Dubai
Phone +971 4 3522215, 3523043
Fax +971 4 3599950
- USA** **USA**
W-Interconnections, Inc.
821 Southlake Boulevard,
Richmond, VA 23236
Phone +1 804 7942877
Fax +1 804 3792593
info@weidmuller.com
www.weidmuller.com
- VN** **Vietnam**
Thien Nghi Trading Pte
60B Tan Da Street
District 5 Ho Chi Min
Phone +84 8 8555387
Fax +84 8 8549304
- YU** **Yugoslavia**
ES YU Elektrosistem d.o.o.
ul. Pariske komune 41
11070 Novi Beograd
Serbia
Phone +381 11 697212, 693608
Fax +381 11 697212, 693608
esyu@infosky.net
www.elektrosistem.co.yu
- Y** **Venezuela**
Somerinca C. A.
Edificio Esteban Piso 2
Calle Vargas Bolleita Notre
Caracas 1070 A
Venezuela
Phone +58 212 2352748
Fax +58 212 2385625
hcastroj@somerincayv.com
- ZA** **South Africa**
RAD Interface Pty. Ltd.
5 Bundo Road
Sebenza Extension
Edenvale 1609
P.O.Box 193
Edenvale 1610
Phone +27 11 452-1930
Fax +27 11 452-6455
- D** **Other countries**
Weidmüller Interface GmbH & Co. KG
P.O. Box 3030
D-32720 Detmold
Phone +49 5231 14-0
Fax +49 5231 14-20 83
info@weidmueller.com
www.weidmueller.com

We cannot guarantee that there are no mistakes in the publications or software provided by us to the customer for the purpose of making orders.

We try our best to correct any fault as soon as it is located. For this purpose we make all corrections, which have been made after publishing a catalogue, available on our website at www.weidmueller.com.

For your convenience we list order no. and catalogue page along.

This Internet-database is part of our catalogue.

All orders are based on our general terms of delivery, which can be reviewed on the websites of our group companies where you placed your order. On demand we can also send the general terms of delivery to you.